

# TC-V Series

## Features

- HMI
- SENSOR
- ENCODER
- COUNTER
- INFORMATION

## Digital Tachometers

- The TC-V series has a compact DIN48 size with an easy-to-see large display.
- With characters represented by bright large red LEDs, 10 mm high characters can be clearly seen from a distance and an angle.
- The green LED is used for the preset value to differentiate it from the measured values.
- The preset value can be easily set to 0 using the setting key corresponding to each digit, like using a digital switch.
- The TC-V series can be easily operated owing to a selection method that uses DIP switches for basic functional setting and the digit keys for detailed setting.



### Features

#### Protection Functions for Each Key

Key protection can be set for each key to prevent unintended operation.

#### Retentive Memory without Battery Backup

An EEPROM is used for memory storage and a battery that does not require maintenance is used.

#### Removable Terminal Block

This removable terminal block improves maintenance. After wiring, the terminal block cover enhances safety.

#### Multi-voltage Power Supply for AC Type

The AC type covers supply voltages of 85 to 264 V AC and can be used for any power source.

#### Protection Fulfilling IP65

Sheet keys are used for the front panel, which enables users to safely operate the device even with wet or unclean hands.

#### Conformity to CE and UL

CE marking compliant and UL standard (UL508) certified product.

#### Prescale Functions

The TC-V series features built-in prescale functions that can convert rotating speed into speed, flow rate, and work load per unit time.

#### Stable Display

The measuring time can be set to stabilize the display at high speed. Measuring time can be selected from 0.2/0.5/1.0/2.0 s.

#### High Speed Response

The measuring input is 20 kHz.

#### High Accuracy

As the measuring method, the period measurement method is used, which can realize high accuracy at low speed.

#### "0" Display Immediately After Rotation Stops

The stop judgment time that immediately displays "0" after rotation stops can be selected from 0.2/0.5/1.0/2.0/6.0 s.

#### With-output Model is Also Available.

The single preset type is available, which supports rotation control.

#### Zero Suppression Function

Unnecessary 0 (zeros) of high-order digits are not displayed.

### Model Number List

Classification	Model Number	Digit	Power Source	Power Source for Sensors 24 V DC, 60 mA	Price
Digital Tachometer with Single Preset	TC-V6S	6	AC	●	Open
	TC-V6S-C		DC		Open
Digital Tachometer Only for Display	TC-V6		AC	●	Open
	TC-V6-C		DC		Open

(Accessories) Mounting frame

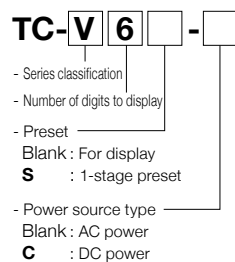





TC-V

TC-4

# TC-V Series

## Specifications

PLC HMI SENSOR ENCODER COUNTER INFORMATION 

Electronic Counter

Tachometer

Digital Timer

Programmable Cam

TC-V

TC-4

### General Specifications

Items	Rating	
	AC Power	DC Power
Supply Voltage	100 to 240 V AC	12 to 24 V DC
Allowable Power Range	85 to 264 V AC	10 to 26.4 V DC
Power Consumption	Approx. 11 VA	Approx. 4 W
Power Source for Sensors	24 V DC (20 to 28 V) 60 mA (Ripple noise:10%p-p or lower)	—
Power Failure Memory	EEPROM Number of overwrite cycles: 100,000 cycles or more Storage time: 10 years	
Ambient Temperature	-10 to 50°C	
Storage Temperature	-20 to 70°C (No freezing)	
Ambient Humidity	35 to 85% RH (No condensation)	
Withstand Voltage	2 kV AC 1 min (AC input, 0 V, between relay contacts) (DC power supply type: 0 V, only between relay contacts)	
Vibration Resistance	Endurance	Displacement amplitude: 0.5 mm, frequency: 10 to 55 Hz, 3 axial directions
	Malfunction	Displacement amplitude: 0.35 mm, frequency: 10 to 55 Hz, 3 axial directions
Impact Resistance	Endurance	490 m/s <sup>2</sup> 11 ms, 3 axial directions
	Malfunction	98 m/s <sup>2</sup> 11 ms, 3 axial directions
Noise Resistance	Between power supply terminals ±1.5 kV (Pulse width 1 μs, start-up 1 ns)	Between power supply terminals ±1.0 kV (Pulse width 1 μs, start-up 1 ns)
Protective Structure	IP65 (Only the front panel part)	
Weight	Approx. 150 g	Approx. 110 g
Terminal Block	Conforming cable	0.25 to 1.66 mm <sup>2</sup>
	Conforming crimp terminal	R1.25-3
	Allowable tightening torque	0.5 Nm

### Performance Specifications

Items	Rating
Type	Tachometer
Setting	Single setting with prediction output/No prediction output (Different model No.)
Digit	6 digits
Display	Measured value display: Red LED, height of characters 10 mm. Preset value display: Green LED, height of characters 7 mm
Counting System	Period measurement system
Measurement Item	Speed of revolution only
Basic Measurement Range	10 to 999,999 rpm (When prescale is 1)
Prescale Functions	$M \times 10^{-n} = 10^{-9}$ to 999,999 $1 \leq M \leq 999,999$ , $0 \leq n \leq 9$
Measurement Accuracy	±0.013% Excluding when low speed input (10 Hz) is selected (±0.1% for low-speed input)
Measuring Time	0.2/0.5/1.0/2.0 s
Input	Input logic: Negative logic (No-voltage input)/Positive logic (Voltage input)
	Input resistance: Positive logic 15 kΩ Negative logic 3.3 kΩ (AC power)/1.8 kΩ (DC power)
	Input voltage: "L" 0 to 3 V "H" 7 to 30 V
Measurement Input Response	10 Hz/20 kHz
External Reset	Minimum signal width: 5 ms
*Output	Non-contact output: NPN open collector output, 24 V 100 mA, withstand voltage: 35 V, residual voltage: 1.5 V or lower Contact output: 1 transfer contact point (1c), 220 V AC 2 A (Resistance load)
*Output Mode	Comparative output/Holding output
Key Protection	Any key setting is enabled.
Installation Method	Dedicated to embedded installation (Terminal block connection)

- Items with an \* mark do not apply to display dedicated models.

# TC-V Series

## Operation

### Measurement Operation

#### (1) Rotating speed display for 1 pulse per revolution

The reciprocal ( $\frac{1}{T}$ ) of the input period (T sec) of IN is multiplied by 60 and displayed as the rotating speed.

\* Counting range input: At the time of 1P/R and prescale 1, the range is 10 to 99,999 rpm.

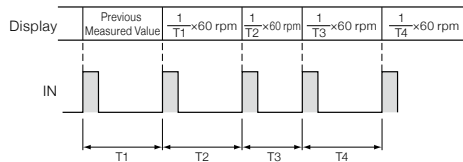

#### Input Single Pulse Width

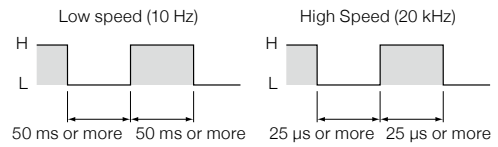

#### (2) Measuring time

This is used for stabilizing the display when the device rotates at high speed. The average pulse that is input during the measuring time is displayed and, if it is larger than the measuring time, the display is updated every time the pulse is input.

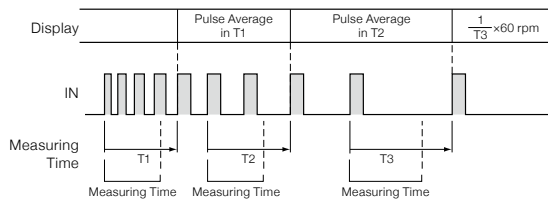

### Output Operation Chart

\* Only models that produce output

#### Holding Output

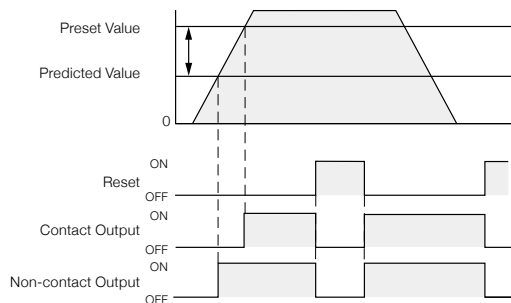

#### Comparative Output

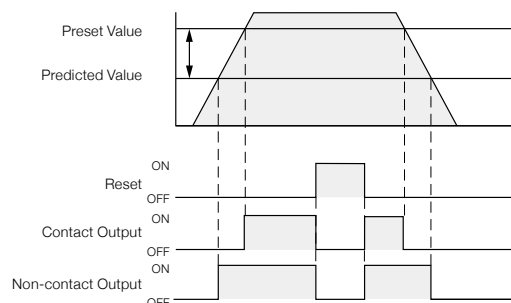

↑ Prediction  
↓ Set Value

When the prediction set value is "0," non-contact output becomes the same as the output operation of contact output.

The prediction set value should be smaller than the preset value. If the prediction setting exceeds the preset value, the measured value becomes 0 and the prediction output (non-contact output) turns ON.



HMI

SENSOR

ENCODER

COUNTER

INFORMATION

Electronic Counter

Tachometer

Digital Timer

Programmable Cam

TC-V

TC-4

# TC-V Series Connection

- PLC
- HMI
- SENSOR
- ENCODER
- COUNTER
- INFORMATION

- Electronic Counter
- Tachometer
- Digital Timer
- Programmable Cam

## Terminal Connection Diagrams

TC-V6S

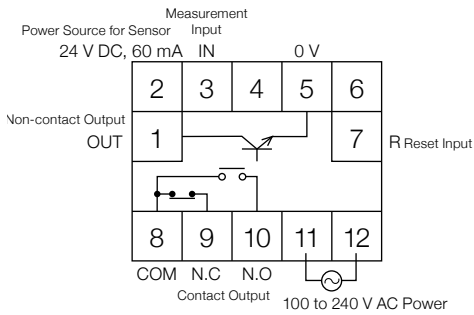

TC-V6S-C

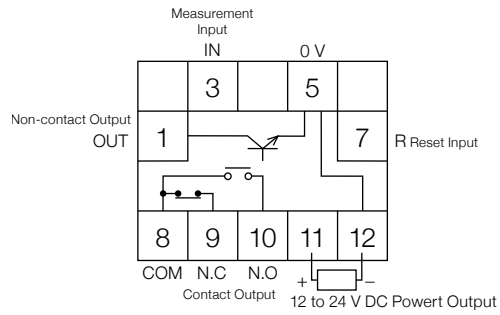

TC-V6

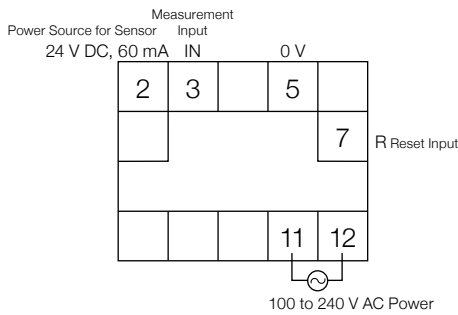

TC-V6-C

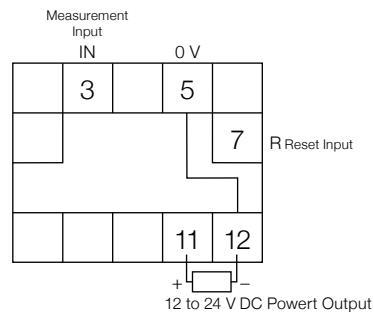

\* Non-contact output (OUT terminal) is also used for prediction output.  
\* Do not connect anything to unconnected terminals.

## Input/Output Circuit Diagrams

AC power

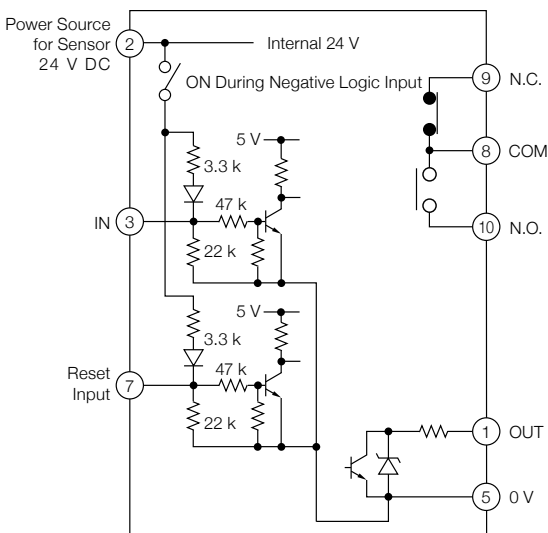

DC power

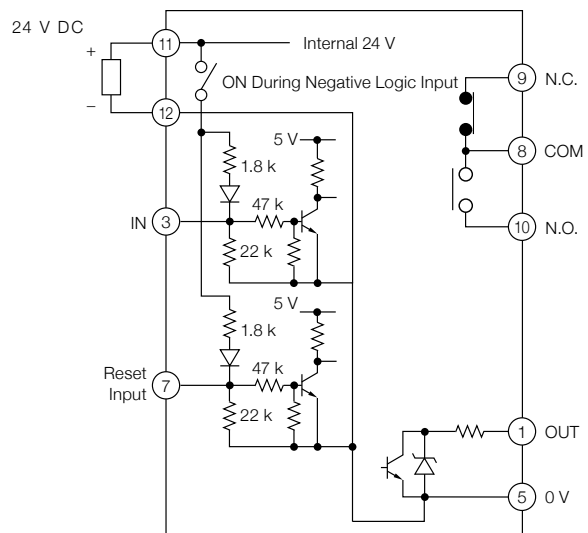

- TC-V
- TC-4

# TC-V Series

## Connection

### Input Connection Examples

#### NPN Open Collector Output Proximity Sensor

- Input logic: Negative logic (No-voltage input) (nE<sub>U</sub>)  
 《Recommended proximity sensor: APS□-□-N/E》

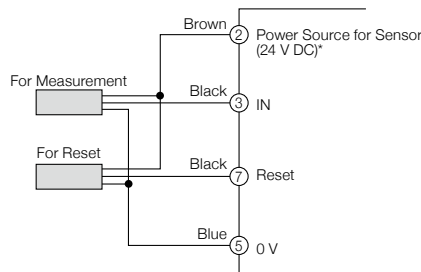

#### Voltage Output or PNP Open Collector Output Proximity Sensor

- Input logic: Positive logic (Voltage input) (P<sub>a5</sub>)  
 《Recommended proximity sensor: APS□-□-E2》

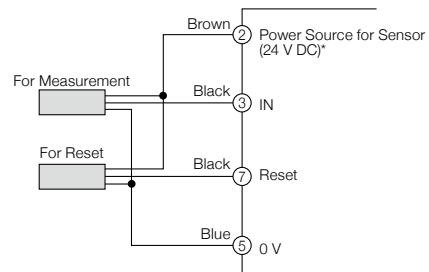

#### 2-wire DC System Proximity Sensor

- Input logic: Negative logic (No-voltage input) (nE<sub>U</sub>)  
 《Recommended proximity sensor: APS□-□-Z》  
 \* In the case of the DC power source type, the supply voltage should be not less than 20 V.

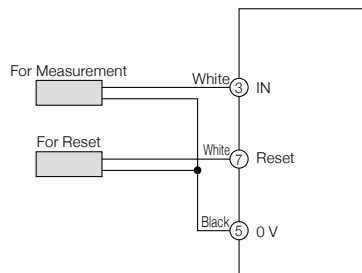

#### Rotary Encoder

- Input logic: Positive logic and negative logic are set in accordance with the output of the encoder.  
 《Recommended rotary encoder: TRD-J□-S, TRD-N□-S》

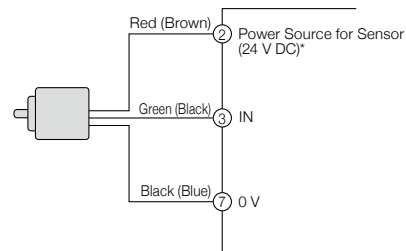

#### Switch Relay

- Input logic: Negative logic (No-voltage input) (nE<sub>U</sub>)  
 - Measurement input response: 10 Hz (DIP switch 1 is ON.)

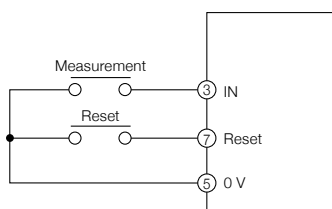

- Input logic: Positive logic (Voltage input) (P<sub>a5</sub>)  
 - Measurement input response: 10 Hz (DIP switch 1 is ON.)

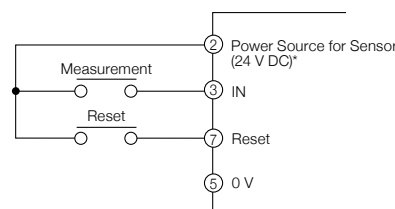

\* There is no power source for sensors in the case of the DC power source type. Use a separate external power source.

### Output Connection Examples

#### NPN Open Collector Output

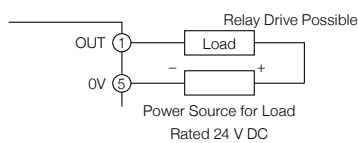

#### Contact Output

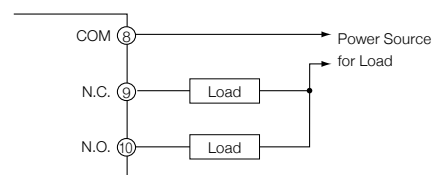





- HMI
- SENSOR
- ENCODER
- COUNTER
- INFORMATION

- Electronic Counter
- Tachometer**
- Digital Timer
- Programmable Cam

- TC-V**
- TC-4

# TC-V Series

## Each Part Name and Function

PLC HMI SENSOR ENCODER COUNTER INFORMATION 

Electronic Counter

Tachometer

Digital Timer

Programmable Cam

### Panel Explanation

#### ① Output display (Red)

- Operation mode  
Lights up when the output is ON.  
Blinks when the prediction output is ON.

#### ② Protection display (Red)

- Operation mode  
Blinks when the key is protected.  
(Only when the key is ON)
- Setup mode  
Displays the set contents of key protection.

#### ⑥ RST key

- Operation mode  
Turns output off.
- Setup mode  
Selects the setting item.

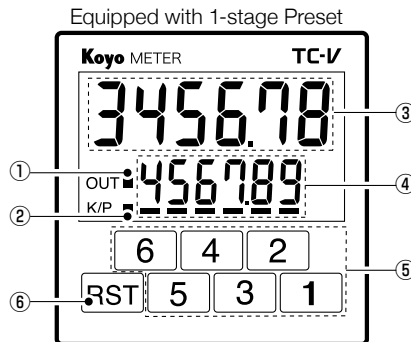

\* Compared with panels equipped with a 1-stage preset, models dedicated to display have the following different points.

- ① Output display : None
- ② Protection display : None
- ④ Preset value display : No display in the operation mode.
- ⑤ Digit key : Ineffective in the operation mode.
- ⑥ RST key : Ineffective in the operation mode.

#### ③ Discrete value display (Red)

- Operation mode  
Displays the discrete value.
- Setup mode  
Displays the set contents.

#### ④ Preset value display (Green)

- Operation mode  
Displays the preset value.
- Setup mode  
Displays the setting item.

#### ⑤ Digit key

- Operation mode  
Changes the preset value.
- Setup mode  
Selects the set contents.

### Key Operation

#### 1. Changes the preset value

Every time a digit key is pressed, 1 is added to the preset value of the corresponding digit.

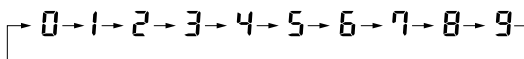

Approx. 1 second after a digit key is released, the set value is entered.

Example: When the counter is "123"

- ① Press the 1 key and the 124
- ② Press the 2 key and the 134
- ③ Press the 3 key and the 234

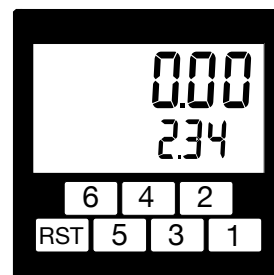

#### 2. Turns output off \* Only for models equipped with single preset

- If the [RST] key is pressed (response time is 0.1s), output turns OFF.
- If the [RST] key is pressed while output is ON, output turns OFF.

#### 3. Key protection \* Only for models equipped with single preset

The key protection can be individually set for each operation key. If a key for which the key protection is set is pressed in the run mode, the LED corresponding to the pressed key blinks to notify that the operation is prohibited.





Since the protection is set to all keys before shipment, if the power is supplied when DIP switch 7 is ON, operation of all keys is prohibited.

TC-V

TC-4

# TC-V Series

## Each Part Name and Function

-  HMI
-  SENSOR
-  ENCODER
-  COUNTER
-  INFORMATION

- Electronic Counter
- Tachometer
- Digital Timer
- Programmable Cam

### DIP Switch Setting

- Use the DIP switches at the top of tachometer for setting.
- Before operating the DIP switches, be sure that the power is turned off. The switches do not respond to setting changes while the power is on.

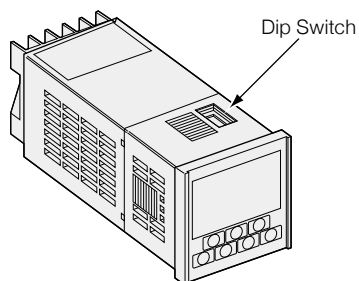

\* The DIP switches are all set in the OFF position before shipment.

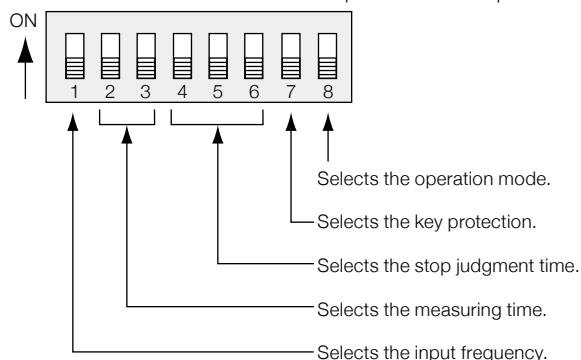

### Input Frequency

Select the input frequency with the DIP switch 1.

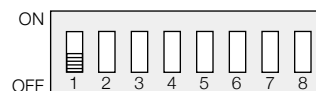

Input Frequency	SW1
10 Hz	ON
20 kHz	OFF

### Measuring Time

Select the measuring time with the DIP switches 2 and 3.

- In the period measurement mode, the display may fluctuate when the device rotates at high speed because the display is updated every time the pulse is input.
- If the measuring time is set, the average pulse input during the measuring time can be displayed and the display becomes stable when the device rotates at high speed.

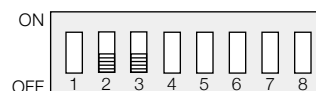

Measuring Time	SW2	SW3
0.2 s	OFF	OFF
0.5 s	OFF	ON
1.0 s	ON	OFF
2.0 s	ON	ON

### Stop Judgment Time

Select the stop judgment time with the DIP switches 4, 5, and 6.

- After the measurement input turns OFF and the stop judgment time elapses, this function makes the display "0."
- Note that, if the stop judgment time is set to 0.2 s in 1P/R, the minimum number of revolutions becomes 300 rpm.

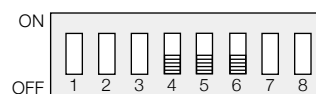

Stop Judgment Time	SW4	SW5	SW6
6.0 s (10)	OFF	OFF	OFF
2.0 s (30)	OFF	OFF	ON
1.0 s (60)	OFF	ON	OFF
0.5 s (120)	OFF	ON	ON
0.2 s (300)	ON	OFF	OFF

The parenthesis represents the minimum number of revolutions in the case of 1 P/R.

### Key Protection

Select whether "not to use key protection" or "to use key protection" for the keys set in the setup mode with DIP switch 7. The keys for key protection can be set in the setup mode.

"Not to use key protection" is set before shipment.

This is for setting protection

\* The models dedicated to display should remain OFF.

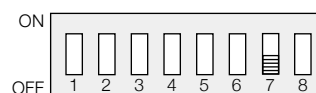

Key Protection	SW7
Setup mode setting is enabled.	ON
Do Not	OFF

### Operation Mode

Select the setup mode and the operation mode with DIP switch 8.

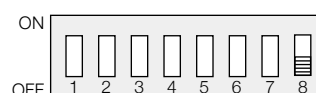

Operation Mode	SW8
Setup mode	ON
Operation mode	OFF

# TC-V Series

## Each Part Name and Function

- PLC
- HMI
- SENSOR
- ENCODER
- COUNTER
- INFORMATION

- Electronic Counter
- Tachometer
- Digital Timer
- Programmable Cam

- TC-V
- TC-4

### Setup Mode

Make settings that cannot be selected with the DIP switches, in the setup mode.

#### Setup Mode Setting Items

- (1) Prescaling ..... Set the prescale value (10<sup>-9</sup> to 999,999).
  - (2) Input logic ..... Positive logic, Negative logic
  - (3) Output mode ..... Comparison / Holding
  - (4) Decimal point ..... Set the decimal marker to any digit.
  - (5) Prediction output ..... Set the offset value for the preset value. 0 to 999,999
  - (6) Reset key protection ..... Set the lock for the reset key.
  - (7) Digit key protection ..... Set the lock for the digit keys.
- \* For tachometers dedicated to display, items (3), (5), (6), and (7) are skipped.

#### Switching Between the Setup Mode and the Operation Mode

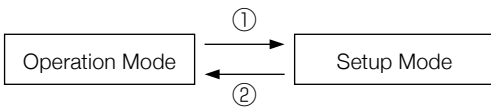

- ① When DIP switch 8 is in the ON position and the power is turned on, the setup mode starts.
- ② When the DIP switch 8 is in the OFF position and the power is turned on, the operation mode starts.

#### Operation of the Setup Mode

Initialize the setup mode using the menu as shown in the table on the right. (Use the digit keys for all settings.)

- For tachometers dedicated to display, the setting items with an \* mark are skipped.
- The set contents become effective when moving to the next menu via the [RST] key.
- The key protection setting becomes active in AND conditions with the DIP switch 7. If you want to activate the protection, set DIP switch 7 in the ON position.

Digit key  : Not use  
 : Use

K/P display part  : Lit when disabled  
 : Enabled when out

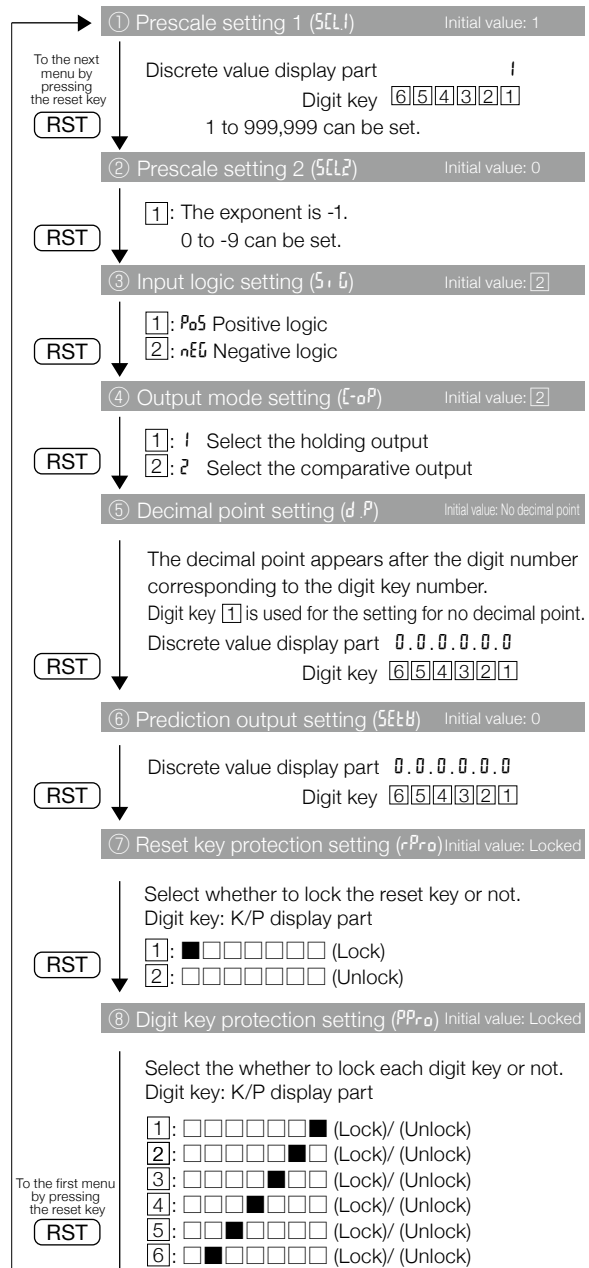



# TC-V Series

## Example of Operation

### Operation Mode

#### Changes the Preset Value

Change the preset value from 120 to 240. The preset value becomes effective approx. 1 second after the change is made.

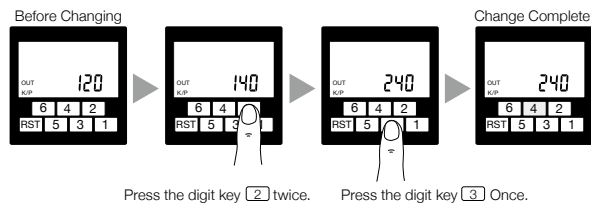

### Example of Setting the Rotating Speed Display

Displays the rotating speed when the rotary encoder of 100 pulses per revolution is used.

Sets the measuring time to 1.0 s to stabilize the display when the encoder rotates at high speed. Moreover, displays the stop judgment time for 1.0 s to 1 decimal place.

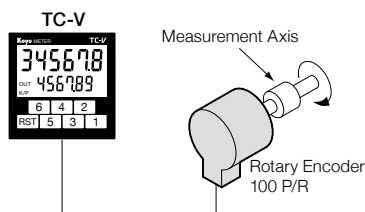

#### Setting item

Setting Item	Contents
Measuring Time	1.0 s
Stop Judgment Time	1.0 s
Prescale Mantissa	1
Prescale Exponent	-2

### 1. Prescale calculation

The tachometer has the prescale "1" at 1 pulse per revolution. Therefore, in the case of 100 P/R,

$$\frac{1}{100} = 0.01$$

Since the prescale setting is set by the mantissa and exponent,

$$0.01 = 1 \times 10^{-2}$$

### 2. Setting DIP switches

Turn the power off before operating the DIP switches.

#### ① Selecting the 1.0 s measuring time

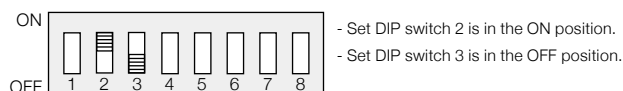

#### ② Selecting the 1.0 s stop judgment time

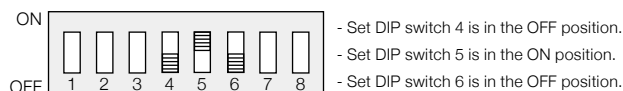

### 3. Switching to the setup mode

Set DIP switch 8 in the ON position, and turn the power on.

### 4. Change the set contents

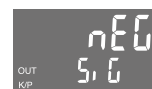
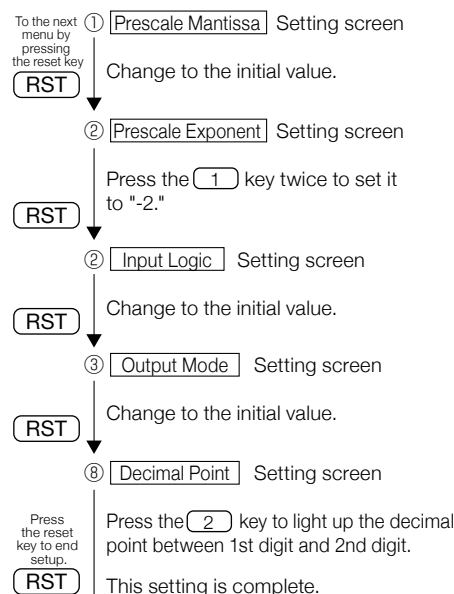

### 5. Switching to the operation mode

When setup is completed in the setup mode, turn the power off, set DIP switch 8 in the OFF position (to the operation mode) and turn ON the power.

### 6. Start the operation mode

When a setting is changed in the setup mode, be sure to press the [RST] key to reset the count value after the power is turned on.



HMI

SENSOR

ENCODER

COUNTER

INFORMATION

Electronic Counter

Tachometer

Digital Timer



Programmable Cam

TC-V

TC-4

# TC-V Series

## Error Code Display/Option

P L C H M I SENSOR ENCODER COUNTER INFORMATION 

Electronic Counter

Tachometer

Digital Timer

Programmable Cam

TC-V

TC-4

### Common Errors

Error Code	Error Name	Error details	Corrective Action
E01	Overflow error	The data that should be displayed is larger than the display range.	The error indication will be automatically reset when the measured value enters the normal range. (Review the prescale and decimal point setting.)
E02	Underflow error	The digit of the data that should be displayed is lower than the display range.	
E04	Over input frequency	Input frequency exceeds 20 kHz.	Lower the input frequency.
E21	Memory data error	Preset value / Set value and the contents of the setup mode changed.	Press the [RST] key and delete the error indication. The measured value and the timing value become "0", the preset value and the set value become "5,000", and the contents of the setup mode revert back to the preshipment defaults.

### Option

Option	Model Number	Contents	Price
Rubber Packing	KC-48P	If installed between the installation panel and TC-V, it prevents the intrusion of water into the control panel.	Open
Front Cover	KC-48C	If installed to the front panel, it protects the counter from exposure to dirt, etc. Material: Soft silicon rubber Key operation is enabled with the front cover installed.	Open

# TC-V Series

## Precautions

### Precautions in Use

- (1) The power source 0 V terminal ⑫ and the input common 0 V terminal ⑤ of the DC type are internally short-circuited.
- (2) Rather than gradually increasing the supply voltage, apply the rated voltage at once using a switch or relay.
- (3) When using the 2-wire DC system proximity sensor, set the input logic to negative logic.
- (4) If the preset value / set value is changed during measurement / timing, the changed value becomes effective approx. 1 second after key input. (The tachometer performs output operation after measurement.)
- (5) Enter the set contents of the DIP switches and the setup mode in the data sheet attached to the main body and keep it for maintenance.
- (6) Do not use the counter in the following environments.
  - Any place where the ambient temperature exceeds 50°C or falls to -10°C or lower.
  - Any place where the ambient humidity exceeds 85% or condensation occurs due to rapid temperature change.
  - Any place that is exposed to dust, iron powder, and corrosive gas.
  - Any place that is exposed to sunlight.
  - Any place where there are large vibrations or shocks.
- (7) When performing a dielectric voltage test or insulation resistance test, separate the main body from the control circuit.
- (8) When the power is shut down, the internal EEPROM is written. Since the number of writing cycles in the EEPROM is not more than 100,000, do not use the tachometer by highly frequent power source operations.

### Cautions in wiring

- Wire cables separately from power lines.
- When using the counter in a place where a lot of noise is generated, separate the main body of the TC-V and the wiring from the noise sources as far as possible.
- Do not use an unused terminal as a relay terminal.
- It is recommended to use a crimp terminal for connections.
- When wiring the cable to the terminals ① and ⑦, if the crimp terminal has a fork shape, do not attach it diagonally. For diagonal attachment, use a round crimp terminal.

In the Case of a Forked Crimp Terminal

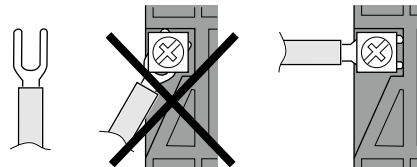

If the crimp terminal is diagonally attached, the contact with the terminal becomes insufficient. Therefore, attach the crimp terminal horizontally from the side as shown in the figure above.

In the Case of a Round Crimp Terminal

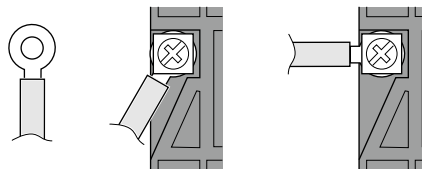

### How to Mount and Remove the Main Body

#### How to mount the main body

- ① Insert the main body into the attachment bore of the panel.

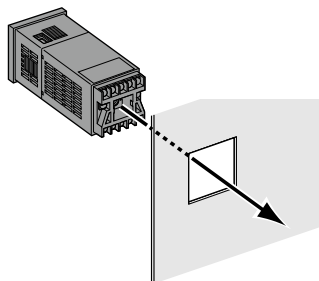

- ② Attach the mounting frame from the backside.

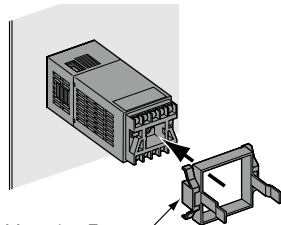

Mounting Frame:  
The frame can be mounted both in the longitudinal and transverse directions.

#### How to remove the main body

- ① Pinch the levers to spread them 2 to 3 mm outwards.
- ② Pull out the frame while the levers are spread.

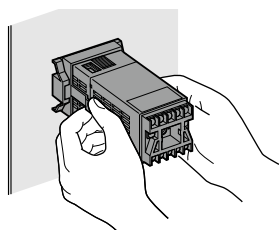

#### How to mount the terminal block and the terminal block cover

- As the screw for anchoring the terminal block, only use the anchoring screw used in shipping.
- Make sure that the allowable tightening torque is 0.3 Nm.
- Mount the terminal block cover after the wiring is completed.

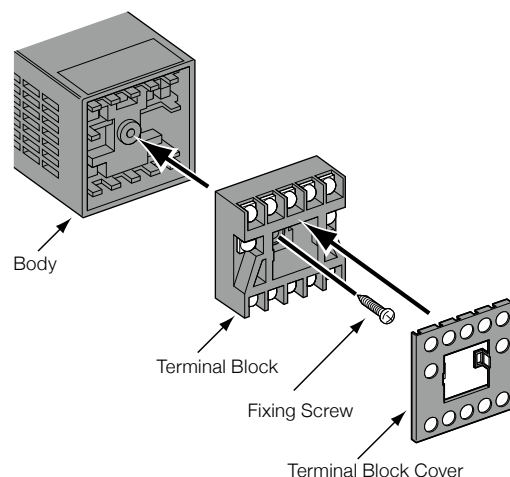

HMI



SENSOR



ENCODER



COUNTER



INFORMATION

Electronic Counter

Tachometer

Digital Timer

Programmable Cam

TC-V

TC-4

# TC-V Series

## Dimensions

- PLC
- HMI
- SENSOR
- ENCODER
- COUNTER**
- INFORMATION

- Electronic Counter
- Tachometer**
- Digital Timer
- Programmable Cam

### Dimensions (Unit: mm)

#### Main Body of the TC-V

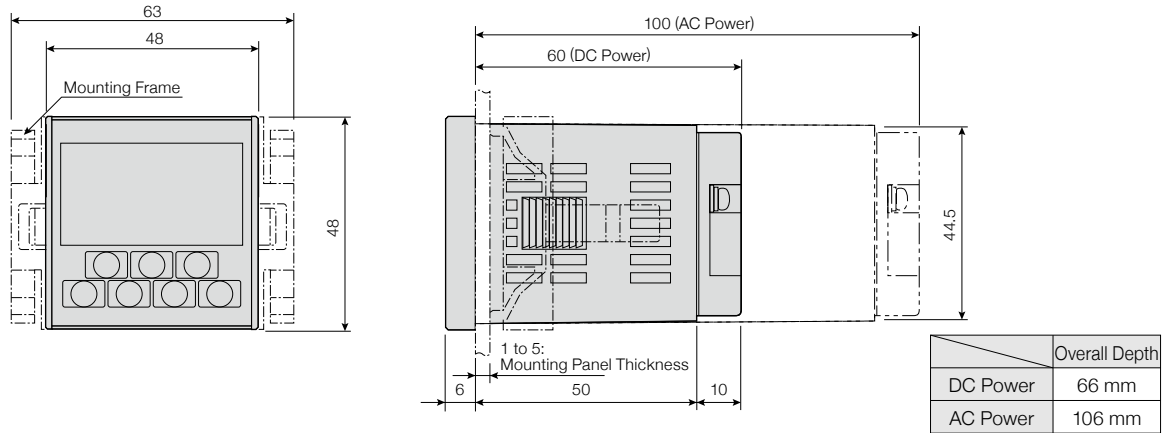

#### Terminal Block Detail Drawing

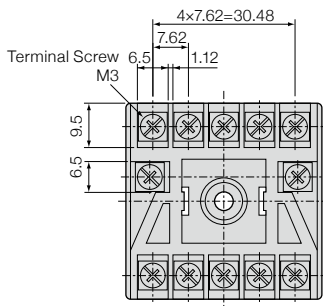

Conforming cable size : 0.25 to 1.65 mm<sup>2</sup>  
 Conforming crimp terminal : R1.25-3  
 Allowable tightening torque: 0.5 Nm

#### Panel-cut Dimensions for Embedded Installation

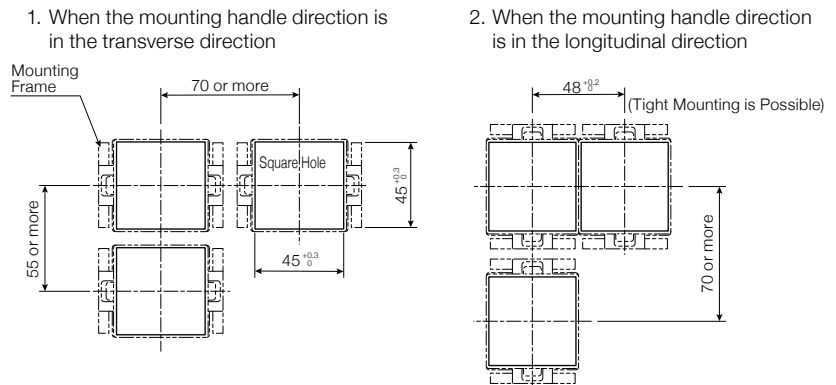

TC-V

TC-4