

TRD-J Series

Features

φ50 Incremental Type

- Long service-life with a φ50 mm miniature case and φ8 mm-thick shaft.
- Realizes 1,024 pulses with a metal slit board that resists vibrations and impacts.
- Wide power range of 4.75 to 30 V DC.
- Totem-pole output suitable for cable extension



Model Number List

Type	Appearance	Model Number	Output	Pulse Number / Rotation
Type with Cables Taken Out from the Back		TRD-J□-S	1-phase output	10* 30 40 50 60 100 120 200 240 300 360 400 500 600 750 1,000 1,024 * 10 pulses are only for the 1-phase output type.
		TRD-J□-RZ	Output with 2-phase origin (Origin direct action □□)	
		TRD-J□-RZL	Output with 2-phase origin (Origin reverse action □□)	
		TRD-J□-RZV	Output with 2-phase origin (Line driver)	
Dustproof and Waterjet-proof Type		TRD-J□-SW	1-phase output	
		TRD-J□-RZW	Output with 2-phase origin (Origin direct action □□)	
		TRD-J□-RZWL	Output with 2-phase origin (Origin reverse action □□)	
		TRD-J□-RZVW	Output with 2-phase origin (Line driver)	
Connector Type		TRD-J□-SC	1-phase output	
		TRD-J□-RZC	Output with 2-phase origin (Origin direct action □□)	
		TRD-J□-RZCL	Output with 2-phase origin (Origin reverse action □□)	
		TRD-J□-RZVC	Output with 2-phase origin (Line driver)	
Dustproof and Waterjet-proof Connector Type		TRD-J□-SCW	1-phase output	
		TRD-J□-RZCW	Output with 2-phase origin (Origin direct action □□)	
		TRD-J□-RZCWL	Output with 2-phase origin (Origin reverse action □□)	
		TRD-J□-RZVCW	Output with 2-phase origin (Line driver)	
Type with Cables Taken Out from the Side <small>Note 1</small>		TRD-J□-SS	1-phase output	
		TRD-J□-RZS	Output with 2-phase origin (Origin direct action □□)	
		TRD-J□-RZSL	Output with 2-phase origin (Origin reverse action □□)	
		TRD-J□-RZVS	Output with 2-phase origin (Line driver)	
Dustproof and Waterjet-proof Type with Cables Taken Out from the Side <small>Note 1</small>		TRD-J□-SWS	1-phase output	
		TRD-J□-RZWS	Output with 2-phase origin (Origin direct action □□)	
		TRD-J□-RZWSL	Output with 2-phase origin (Origin reverse action □□)	
		TRD-J□-RZVWS	Output with 2-phase origin (Line driver)	

Note 1: Made-to-order product. Consult with us about delivery dates.

TRD-J □ - RZ V W L - □

- Series classification
- Pulse number
- Signal format
S : 1-phase output
RZ: Output with 2-phase origin (Origin direct action)
- Output format
Blank: Totem-pole output
V : Line driver output
- Connection method
Blank: Type with cables taken out from the back
W : Dustproof and waterjet-proof type
C : Connector type
CW : Dustproof and waterjet-proof connector type
S : Type with cables taken out from the side
WS : Dustproof and waterjet-proof type with cables taken out from the side
- Origin reverse action symbol
If the signal type is RZ, models with "L" produce the origin reverse action.
- (Special specifications products)

- HMI
- SENSOR
- ENCODER
- COUNTER
- INFORMATION

- Rotary Encoder Lineup
- Selection Guide
- Incremental Type
- Absolute Type

- TRD-MX
- TRD-S/SH
- TRD-2E
- TRD-N/NH
- TRD-J
- TRD-GK

TRD-J Series Specifications

- PLC
- HMI
- SENSOR
- ENCODER**
- COUNTER
- INFORMATION

- Rotary Encoder Lineup
- Selection Guide
- Incremental Type**
- Absolute Type

- TRD-MX
- TRD-S/SH
- TRD-2E
- TRD-N/NH
- TRD-J**
- TRD-GK

Pulse and Frequencies

Pulse Number per Rotation	10	30	40	50	60	100	120	200	240	300	360	400	500	600	750	1,000	1,024
Maximum Response Frequency (kHz)*	0.5	1.5	2	2.5	3	5	6	10	12	15	18	20	25	30	37.5	50	51.2
Applicable Models	TRD-J□-S□	●	●	●	●	●	●	●	●	●	●	●	●	●	●	●	●
	TRD-J□-RZ□		●	●	●	●	●	●	●	●	●	●	●	●	●	●	●
	TRD-J□-RZV□		●	●	●	●	●	●	●	●	●	●	●	●	●	●	●

* The electric maximum response frequency is specified by resolution (pulse number) and the maximum number of revolutions.
 Electrical maximum number of revolutions = (Maximum response frequency/Resolution) x 60
 Therefore, if the encoder rotates at a speed greater than the electrical maximum number of revolutions, the signals do not electrically follow.

Electrical Specifications

Model Number		TRD-J□-S□	TRD-J□-RZ□	TRD-J□-RZV□	
Power Supply	Supply Voltage	4.75 to 30 V DC	4.75 to 30 V DC	4.75 to 5.25 V DC	
	Allowable Ripple	3% rms or less	3% rms or less	3% rms or less	
	Consumption Current (No Load)	40 mA or lower (See the figure on consumption current characteristics.)	60 mA or lower (See the figure on consumption current characteristics.)	130 mA or lower	
Output Waveform	Signal Format	1-phase output	2-phase output + home position	2-phase output + home position	
	Duty Ratio	50±25%	50±25%	50±25%	
	Signal Width at Home Position	—	50 to 150%	50 to 150%	
Output	Rise / Fall Time*1	Not larger than 3 μs	Not larger than 3 μs	Not larger than 2 μs	
	Output Form	Totem-pole output	Totem-pole output	Line driver output*2	
	Output Current	Source "H"	Up to 10 mA	Up to 10 mA	—
		Sink "L"	Up to 30 mA	Up to 30mA	—
	Output Voltage	"H"	[(Supply Voltage) - 2.5 V] or more	[(Supply Voltage) - 2.5 V] or more	2.5 V or higher
		"L"	0.4 V or lower	0.4 V or lower	0.5 V or lower
	Output Standard	TTL5 V	10 TTL	10 TTL	—
Load Supply Voltage		30 V DC or lower	30 V DC or lower	—	

*1: Cable 0.5 m or shorter, maximum load

*2: Equivalent to 26LS31 (Output signal is TTL-compatible.)

Mechanical Specifications

Starting Torque	0.003 N·m or less (+20°C) (However, 0.02N·m or lower for dustproof and waterjet-proof type)
Moment of Inertia	2 x 10 ⁻⁶ kg·m ²
Shaft Allowable Load	Radial: 50 N
	Thrust: 30 N
Maximum Allowable Number of Revolutions (Note 1)	5,000 rpm (However, 3,000 rpm (continuously) for dustproof and waterjet-proof type)
Bearing Life	5 x 10 ³ rounds (Calculated value at the maximum load)
Cable	Outside diameter ϕ 5 mm (W type is ϕ 6mm) 5-core shielded oil-resistant vinyl chloride cable Core wire nominal cross-sectional area: 0.3 mm ² (Line driver output is 8 cores, 0.14 mm ²)
Weight	220 g or less (With 0.5 m cable)

Note 1: Maximum number of revolutions that can be mechanically endured

Environmental Requirements

Use Ambient Temperature	-10 to +50°C
Storage Ambient Temperature	-25 to +85°C
Use Ambient Humidity	35 to 85% RH (No condensation)
Withstand Voltage	500 V AC 1 minute*
Insulation Resistance	50 MΩ or higher*
Vibration Resistance (Endurance)	Displacement half amplitude: 0.75 mm, 10 to 55 Hz, 3 axial directions, each 1 h
Impact Resistance (Endurance)	490 m/s ² 11 ms, each 3 times in 3 axial directions
Protective Structure	Dustproof type: IP50 Dustproof and Waterjet-proof type: IP65

* The power supply, signal lines, and shield between the cases are excluded.

TRD-J Series

Specifications

Output Waveform

Totem-pole

《1-phase output》

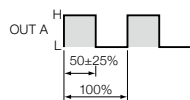

《Output with 2-phase origin》

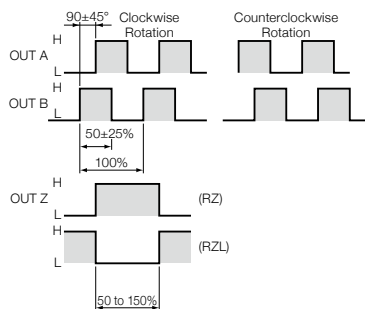

Note: Clockwise rotation when the main body is seen from the axle side is the normal rotation.

Line Driver

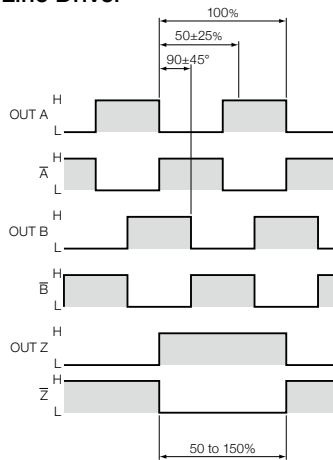

Note: Clockwise rotation when the main body is seen from the axle side is the normal rotation.

Electrical Characteristics (Typical)

Consumption Current Characteristics

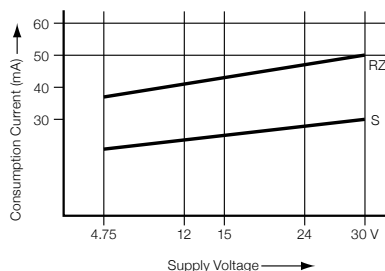

Output Circuit

Totem-pole

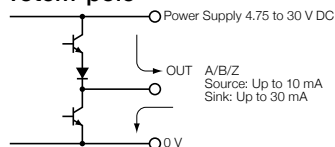

The totem-pole output supports both voltage output and open collector output.

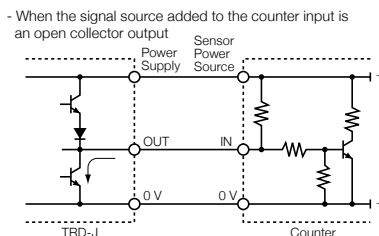
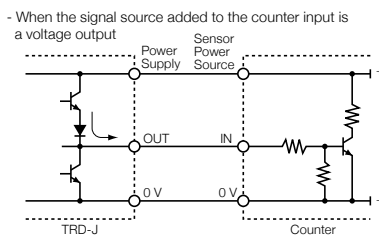

Line Driver

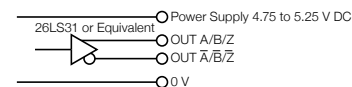

- The line driver output comes from a data transmission circuit that conforms to RS-422A and can transmit data up to 1,200 m over twisted pair cables.

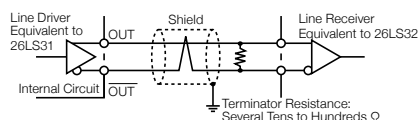

- When the transmission line or connector is disconnected, the output becomes "H."

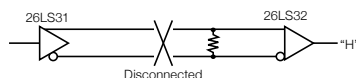

Connection Diagram

Totem-pole

《1-phase output》

The shielded wire is connected to the main body.

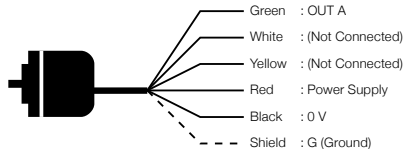

Connector
《Pin Assignment Figure》

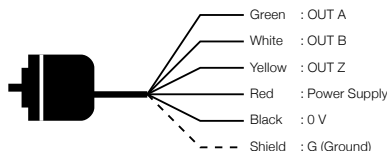

*Figure Seen from Wiring Side (Back side)

- Pin Code
- A: OUT A
 - B: (Not Connected)
 - C: (Not Connected)
 - D: Power Supply
 - E: 0 V
 - F: (Not Connected)

《Output with 2-phase origin》

The shielded wire is connected to the main body.



Connector
《Pin Assignment Figure》

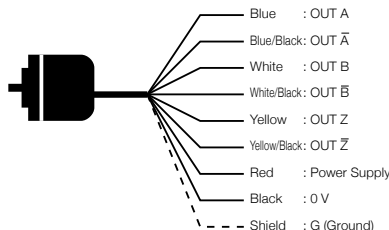

*Figure Seen from Wiring Side (Back side)

- Pin Code
- A: OUT A
 - B: OUT B
 - C: OUT Z
 - D: Power Supply
 - E: 0 V
 - F: (Not Connected)

Line Driver

The shielded wire is connected to the main body.



Connector
《Pin Assignment Figure》



*Figure Seen from Wiring Side (Back side)

- Pin Code
- A: OUT A
 - B: OUT A-bar
 - C: OUT B
 - D: OUT B-bar
 - E: OUT Z
 - F: OUT Z-bar
 - G: Power Supply
 - H: 0 V



HMI



SENSOR



ENCODER



COUNTER



INFORMATION

Rotary Encoder Lineup

Selection Guide

Incremental Type

Absolute Type

TRD-MX

TRD-S/SH

TRD-2E

TRD-N/NH

TRD-J

TRD-GK

TRD-J Series

Dimensions

- PLC
- HMI
- SENSOR
- ENCODER**
- COUNTER
- INFORMATION

- Rotary Encoder Lineup
- Selection Guide
- Incremental Type**
- Absolute Type

- TRD-MX
- TRD-S/SH
- TRD-2E
- TRD-N/NH
- TRD-J**
- TRD-GK

Dimensions

(Unit: mm)

Type with Cables Taken out from the Back

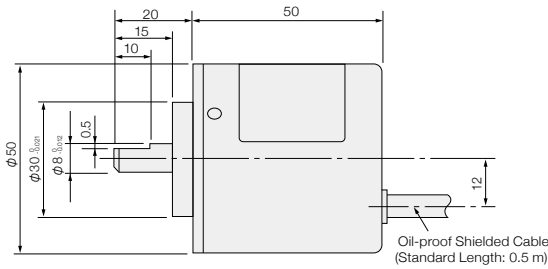
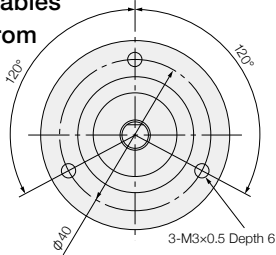

Dustproof and Waterjet-proof Type (W type)

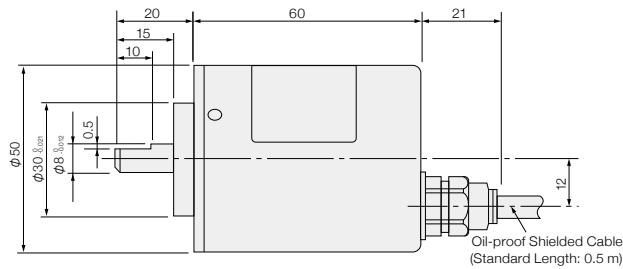
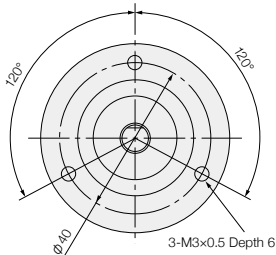

Connector Type (C type)

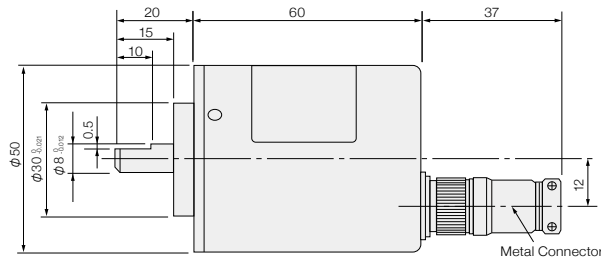
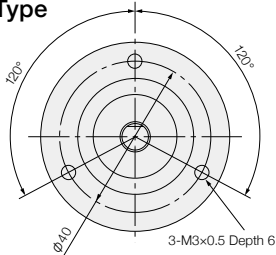

Model numbers of connectors

- Totem-pole output (S□/RZ□)
Body : R03-R6F
Cable : R03-PB6M (Provided)
- Line driver output (RZV□)
Body : R03-R8F
Cable : R03-PB8M (Provided)
(Made by Tajima Musen)
- * Connecting wire cross-section: 0.3mm² or less
Diameter of cable duct: φ 6.2

Dustproof and Waterjet-proof Type Connector Type (CW type)

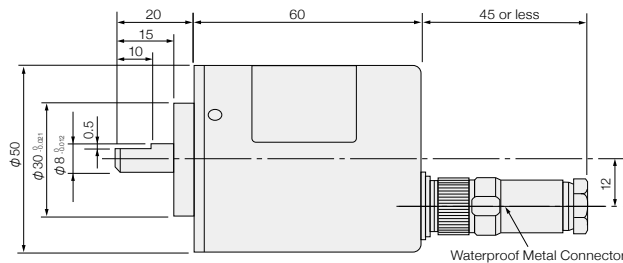
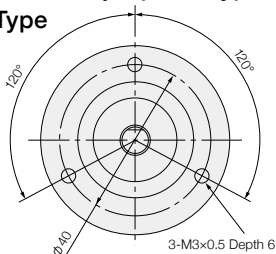

Model numbers of connectors

- Totem-pole output (S□/RZ□)
Body : R04-R6F
Cable : R04-P6M (Provided)
- Line driver output (RZV□)
Body : R04-R8F
Cable : R04-P8M (Provided)
(Made by Tajima Musen)
- * Connecting wire cross-section: 0.3mm² or less
Diameter of cable duct: φ 6.2

Type with Cable Taken out from the Side (S type)

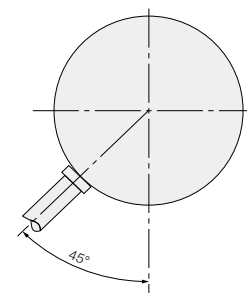
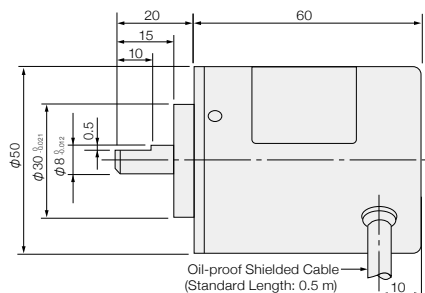
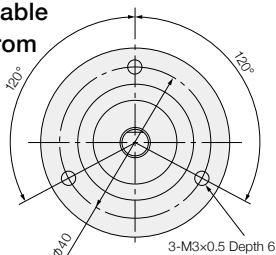

Dustproof and Waterjet-proof Type Type with Cable Taken Out from the Side (WS type)

