

TRD-MX Series

Features

φ25 Incremental Type

Ultraminiature design with outside diameter of φ25 mm/ depth of 29 mm/ shaft diameter of φ4 mm
Small diameter lineup with resolutions up to 1,024 P/R. Line driver output is available.

- Pulse number: 100, 200, 360, 500, 512, 600, 1,000, 1,024P/R
- Supply voltage: 5 to 24 V DC
- Maximum allowable number of revolutions: 6,000 rpm
- Output signal format: 2-phase output + Origin
- Output form: NPN open collector / line driver
- IP50 (Dustproof type)



Model Number List

Type	Appearance	Model Number	Supply Voltage	Output	Output Form	Pulse Number / Rotation
Shaft Type		TRD-MX□A	4.5 to 13.2 V DC	Output with 2-phase origin (Origin reverse action □)	Open collector output	100, 200, 360, 500, 512, 600, 1,000, 1,024
		TRD-MX□B	10.8 to 26.4 V DC			
		TRD-MX□V	4.75 to 5.25 V DC	Output with 2-phase origin (Origin direct action □)	Line driver output	

TRD-MX □ A

- Series classification
- Pulse number
- Form

- A:** Supply voltage 4.5 to 13.2 V DC Open collector output
- B:** Supply voltage 10.8 to 26.4 V DC Open collector output
- V:** Supply voltage 4.75 to 5.25 V DC Line driver output

Pulse and Frequencies

Pulse Number per Rotation	100	200	360	500	512	600	1,000	1,024
Maximum Response Frequency (kHz)*	10	20	36	50	50	60	100	100
Applicable Models	TRD-MX□A	●	●	●	●	●	●	●
	TRD-MX□B	●	●	●	●	●	●	●
	TRD-MX□V	●	●	●	●	●	●	●

* The electric maximum response frequency is specified by resolution (pulse number) and the maximum number of revolutions.
Electrical maximum number of revolutions = ((Maximum response frequency/Resolution) x 60)
Therefore, if the encoder rotates at a speed greater than the electrical maximum number of revolutions, the signals do not electrically follow.

Electrical Specifications

Model Number	TRD-MX□A		TRD-MX□B		TRD-MX□V		
Power Supply	Supply Voltage	4.5 to 13.2 V DC		10.8 to 26.4 V DC		4.75 to 5.25 V DC	
	Allowable Ripple	3% rms or less					
	Consumption Current (No Load)	50 mA or lower					
Output Waveform	Signal Format	2-phase output + home position					
	Maximum Response Frequency	(Maximum Response Frequency/Resolution) x 60					
	Duty Ratio	50 ± 25%					
	Phase Difference Width	25 ± 12.5%					
	Signal Width at Home Position	100 ± 50%					
Output	Rise / Fall Time	Not larger than 2 μs (Cable length 1 m, maximum load)					
	Output Form	NPN open collector output			Line driver output*		
	Output Logic	Negative logic (Active low)			Positive logic (Active high)		
	Output Voltage	"H"	—			2.5 V or higher	
		"L"	0.4 V or lower			0.5 V or lower	
	Output Current	Influx	Up to 30 mA			Up to 20 mA	
Outflow		—			—		
Load Supply Voltage	30 V DC or lower						

* Equivalent to 26C31. The receiver is equivalent to 26C32.

- HMI
- SENSOR
- ENCODER
- COUNTER
- INFORMATION

- Rotary Encoder Lineup
- Selection Guide
- Incremental Type
- Absolute Type

- TRD-MX
- TRD-S/SH
- TRD-2E
- TRD-N/NH
- TRD-J
- TRD-GK

TRD-MX Series

Specifications/Dimensions

- PLC
- HMI
- SENSOR
- ENCODER
- COUNTER
- INFORMATION

- Rotary Encoder Lineup
- Selection Guide
- Incremental Type
- Absolute Type

- TRD-MX
- TRD-S/SH
- TRD-2E
- TRD-N/NH
- TRD-J
- TRD-GK

Mechanical Specifications

Starting Torque	0.001 N·m or less (20°C)
Moment of Inertia	$1 \times 10^{-7} \text{ kg} \cdot \text{m}^2$
Shaft Allowable Load	Radial: 10 N
	Thrust: 5 N
Maximum Allowable Number of Revolutions (Note 1)	6,000 rpm
Cable	Outside diameter $\phi 5 \text{ mm}$ 5-core shielded oil-resistant vinyl chloride cable Core wire nominal cross-sectional area: 0.14 mm ² (Line driver output is 8 cores, 0.14 mm ²)
Weight	Approx. 80 g

Note 1: Maximum number of revolutions that can be mechanically endured

Environmental Requirements

Use Ambient Temperature	-10 to +70°C
Storage Ambient Temperature	-25 to +85°C
Use Ambient Humidity	35 to 85% RH (No condensation)
Withstand Voltage	Excluded due to capacitor grounding
Insulation Resistance	20 MΩ or higher
Vibration Resistance (Endurance)	Displacement half amplitude: 0.75 mm, 10 to 55 Hz, 3 axial directions, each 1 h
Impact Resistance (Endurance)	490 m/s ² 11 ms, each 3 times in 3 axial directions
Protective Structure	Dustproof type: IP50

Output Waveform

Open Collector

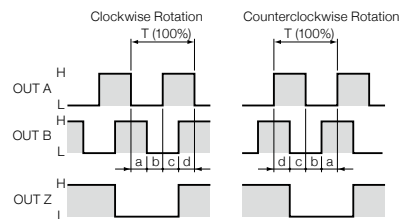

Output Circuit

Open Collector

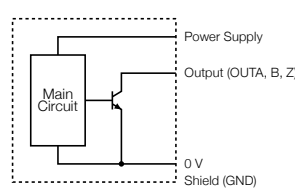

Connection Diagram

Open Collector

The shielded wire is connected to the main body.

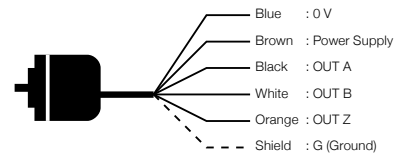

Line Driver

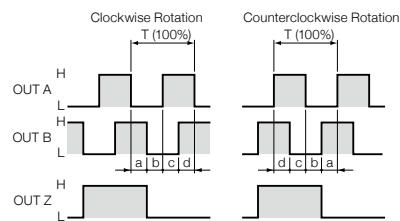

$a, b, c, d = 1/4T \pm 1/8T$

Note: Clockwise rotation when the main body is seen from the axle side is the normal rotation.

Line Driver

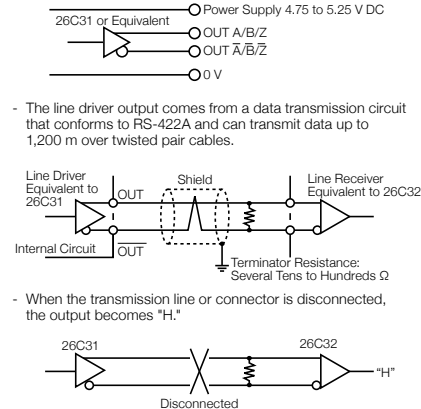

Line Driver

The shielded wire is connected to the main body.

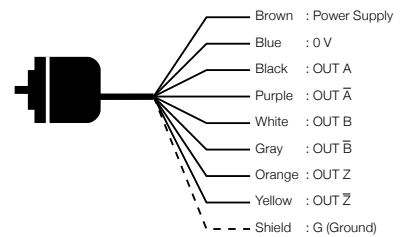

Dimensions

(Unit: mm)

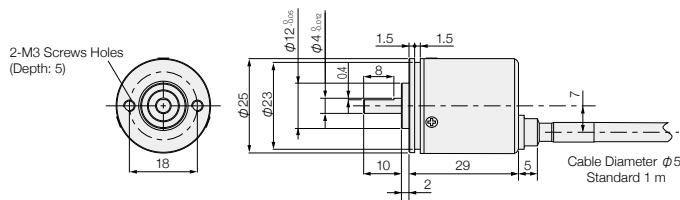

Attachment Bore Processing

Dimension Diagram

(For servo mount metal fixture)

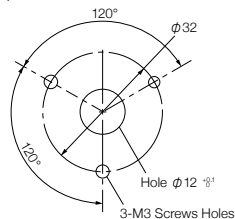

Attachment Bore Processing

Dimension Diagram

(For 2 holes)

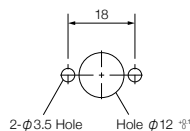

Servo Mount Metal Fixture MM-4

(Option)

