

APS-10 to 15 Series

Features

PBT Resin Square Type, 2-wire/3-wire DC System

- Front/Upper/Side surface detection
- High reliability based on long history of various adoptions
- DC voltage / NPN output



- HMI
- SENSOR**
- ENCODER
- COUNTER
- INFORMATION

- Proximity Sensor Lineup
- Selection Guide
- Outline
- Cylinder Type
- Square Type**
- Capacitive Type

Type

DC Voltage Output Type/3-wire DC System





Output Form	Operating Distance (mm)			Output Form	Model Number	Remarks			
Non-flush Mount Type	4			NPN NO	APS-10-4N				
				NPN NO	APS-11-4N				
				DC voltage	APS-12A-4T				
				NPN NO	APS-12A-4N				
				DC voltage	APS-13-4T				
				NPN NO	APS-13-4N				
	7			DC voltage	APS-13-7T				
				NPN NO	APS-13-7N				
				15			DC voltage	APS-14-15T	
							NPN NO	APS-14-15N	
							NPN NO	APS-15-15N	

Note: The manufacturing of these products will be discontinued after the discontinued components are finished.

- APS-S/M
- APS-F/U
- APS-10 to 15**

APS-10 to 15 Series

DC Voltage Output Type/3-wire DC System Non-flush Mount Type

PLC HMI SENSOR ENCODER COUNTER INFORMATION Proximity
Sensor Lineup

Selection Guide

Outline

Cylinder Type



Square Type

Capacitive Type

APS-S/M

APS-F/U

APS-10 to 15

Effective Operating Distance	4 mm ±10%	4 mm ±10%	4 mm ±10%	
Photo				
Remarks	Front detection	Top detection	Front detection	
Output Form	DC Voltage	Model Number	APS-12A-4T	
		Price	Open	
	NPN NO	Model Number	APS-10-4N	APS-11-4N
		Price	Open	Open
Rated Working Voltage	T Type	—	12 V DC (10 to 16 V DC) Allowable ripple rate: Not more than 3%p-p	
	N Type	Manufactured in March 2000 or earlier: Up to 60 mA (Load voltage: 40 V or less) Allowable ripple rate: Not more than 3%p-p Manufactured in April 2000 or later: +12 V DC: Up to 100 mA (Load voltage: 40 V or less) +24 V DC: Up to 200 mA (Load voltage: 40 V or less) Allowable ripple rate: Not more than 3%p-p	24 V DC (20 to 30 V) Allowable ripple rate: Not more than 3%p-p	
No-load Current	15 mA or lower	10 mA or lower		
Standard Target Object (mm)	Iron 20 x 20 x 1 t			
Guaranteed Operating Distance	0 to 2.8 mm			
Reaction Material	Iron/Non ferrous metal (Operating distance changes depending on materials.)			
Hysteresis	Approx. 10%			
Operating Cycle Frequency	T Type	—	1 kHz	
	N Type	100 Hz	1 kHz	
Output	T Type	—	Output impedance: 3.3 kΩ (Output standard: 4P4N)	
	N Type Rated Working Current	Manufactured in March 2000 or earlier: Up to 60 mA (Load voltage: 40 V or less) Manufactured in April 2000 or later: +12 V DC: Up to 100 mA (Load voltage: 40 V or less) +24 V DC: Up to 200 mA (Load voltage: 40 V or less)	100 mA (+40°C) 80 mA (+50°C) (Load voltage: Not more than 50 V)	
Voltage Drop	1.0 V or lower			
Off-state Current	300 μA or less			
Indicator Lamp	Operation indication			
Use Ambient Temperature	-10 to +50°C	T type: -25 to +60°C N type: -10 to +50°C		
Temperature Characteristics	Within ±20% (At the operating distance at +20°C)			
Withstand Voltage	500 V AC 50/60 Hz (1 minute)			
Insulation Resistance	5 MΩ or higher (500 V DC)			
Vibration Resistance	Double amplitude: 1.5 mm, 10 to 55 Hz (2 h each for X, Y and Z direction)			
Impact Resistance	300 m/s ² , within 11 ms (10 times each for X, Y and Z direction)			
Protection Level	IP67			
Case Material	PBT resin			
Lead Wire	Oilproof vinyl chloride cable 1.5 m Outside diameter (Approx. φ4) 0.3 mm ² , 3 core	Oilproof vinyl chloride cable 1 m Outside diameter (Approx. φ4) 0.3 mm ² , 3 core		
Tightening Torque	0.5 Nm or less	0.4 Nm or less		
Weight (g)	Approx. 50			

APS-10 to 15 Series

DC Voltage Output Type/3-wire DC System Non-flush Mount Type



HMI



SENSOR



ENCODER



COUNTER



INFORMATION

Proximity Sensor Lineup



Selection Guide

Outline

Cylinder Type

Square Type

Capacitive Type

Effective Operating Distance		4 mm ±10%	7 mm ±10%	15 mm ±15%		
Photo						
Remarks		Front detection		Front detection (Detector surface A) Side detection (Detector surface B)		
Output Form	DC Voltage	Model Number	APS-13-4T	APS-13-7T	APS-14-15T	
		Price	Open	Open	Open	
	NPN NO	Model Number	APS-13-4N	APS-13-7N	APS-14-15N	APS-15-15N
		Price	Open	Open	Open	Open
Rated Working Voltage	T Type	12 V DC (10 to 16 V DC) Allowable ripple rate: 3% p-p or less				
	N Type	24 V DC (20 to 30 V DC) Allowable ripple rate: 3% p-p or less				
No-load Current		T type: 15 mA or lower N type: 10 mA or lower				
Standard Target Object (mm)		Iron 20 x 20 x 1 t	Iron 30 x 30 x 1 t	Iron 50 x 50 x 1 t		
Guaranteed Operating Distance		0 to 2.8 mm	0 to 4.9 mm	0 to 10.5 mm		
Reaction Material		Iron/Non ferrous metal (Operating distance changes depending on materials.)				
Hysteresis		Approx. 10%				
Operating Cycle Frequency	T Type	250 Hz	200 Hz	100 Hz		
	N Type	300 Hz	100 Hz			
Output	T Type	Output impedance: 1.8 kΩ (Output standard: 7P6N)				
	N Type Rated Working Current	300 mA (+40°C or less) 200 mA (+50°C or less) (Load voltage: 50 V or less)				
Voltage Drop		2.4 V or lower				
Off-state Current		800 μA or less		300 μA or less		
Indicator Lamp		Operation indication				
Use Ambient Temperature		-10 to +50°C				
Temperature Characteristics		Within ±20% (At the operating distance at +20°C)				
Withstand Voltage		500 V AC 50/60 Hz (1 minute)				
Insulation Resistance		5 MΩ or higher (500 V DC)				
Vibration Resistance		Double amplitude: 1.5 mm, 10 to 55 Hz (2 h each for X, Y and Z direction)				
Impact Resistance		300 m/s ² , within 11 ms (10 times each for X, Y and Z direction)				
Protection Level		IP66				
Case Material		PBT resin				
Lead Wire		Oilproof vinyl chloride cable 1.5 m Outside diameter (Approx. φ6) 0.5 mm ² , 3 core				
Tightening Torque		0.8 Nm or less				
Weight (g)		Approx. 150				

APS-S/M

APS-F/U

APS-10 to 15

APS-10 to 15 Series

Connection and Operation

- PLC
- HMI
- SENSOR**
- ENCODER
- COUNTER
- INFORMATION

Connection/Operation

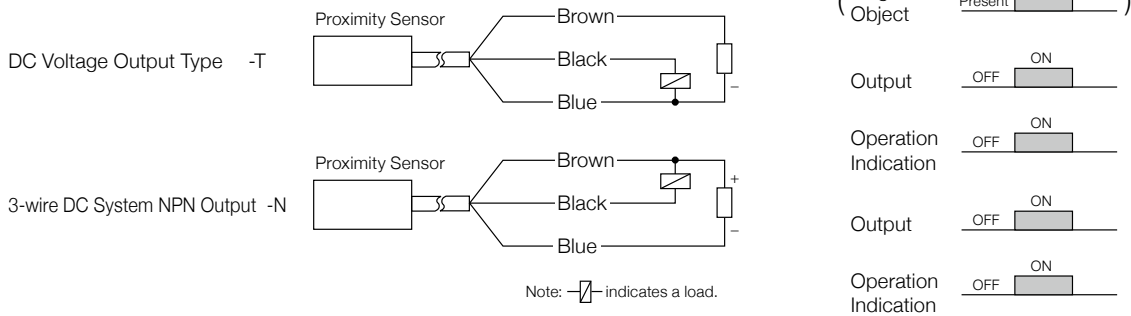

Installation / Effects of Surrounding Metal

Since the proximity sensor is affected by surrounding metal, install it remotely enough from the described dimensions.

(Unit: mm)

Installation	Parallel arrangement of infinite plane metal body	Parallel arrangement of plane metal body to the detector surface	Arrangement to fenestrate metal body	Arrangement of metal body at the front	Parallel arrangement	Opposing arrangement (Front detection type)
Model Number	A	B	C	D	D1	D2
APS-10-4...	10	6	25	10	30	40
APS-11-4...	10	6	25	10	30	40
APS-12A-4	13	10	35	10	80	100
APS-13-4...	13	11	35	10	80	100
APS-13-7...	18	15	50	18	140	180
APS-14-15...	25	17.5	70	35	150	200
APS-15-15...	25	17.5	70	35	150	200

* Position of the target body in the upper surface detection models.

- When there is metal around the proximity sensor, the operating distance changes and makes operation unstable. Therefore, place the surrounding metal as remotely as possible from the proximity sensor.
- Since the D dimension (mm) is the minimum value from the proximity sensor's detector surface to the surrounding metal body, place the metal more remotely than the numeric values shown in the table above.

- Proximity Sensor Lineup
- Selection Guide
- Outline
- Cylinder Type
- Square Type**
- Capacitive Type

APS-S/M

APS-F/U

APS-10 to 15

APS-10 to 15 Series

DC Voltage Output Type/3-wire DC System Non-flush Mount Type

Detection Range Diagram (Representative Examples)

APS-10-...
APS-11-...

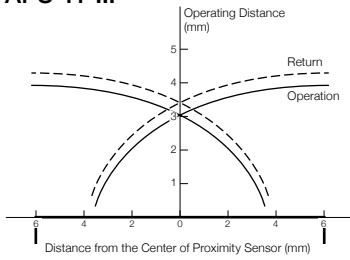

APS-12A-...

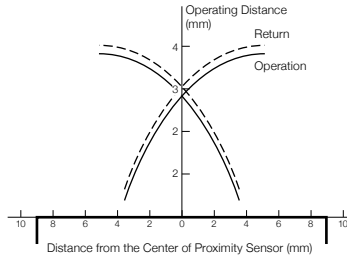

APS-13-4...
APS-13-7...

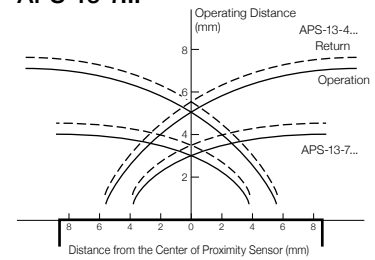

APS-14-...
APS-15-...

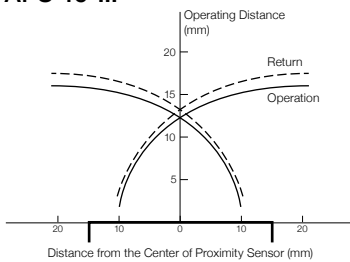

Shape Based Characteristics (Representative Examples)

APS-10-...
APS-11-...

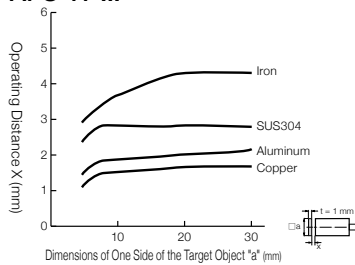

APS-12A-...

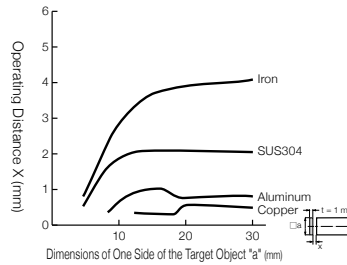

APS-13-4...

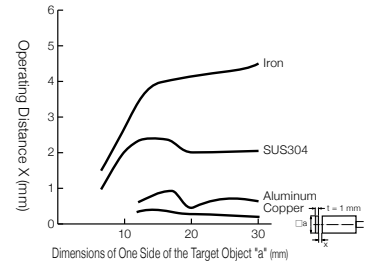

APS-13-7...

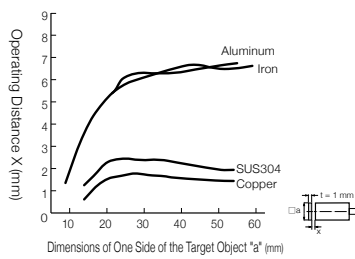

APS-14-...
APS-15-...

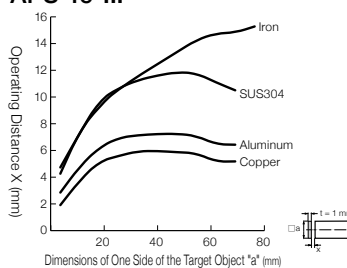

- Proximity Sensor Lineup
- Selection Guide
- Outline
- Cylinder Type
- Square Type
- Capacitive Type

APS-S/M

APS-F/U

APS-10 to 15

APS-10 to 15 Series

DC Voltage Output Type/3-wire DC System Non-flush Mount Type

- PLC
- HMI
- SENSOR
- ENCODER
- COUNTER
- INFORMATION

- Proximity Sensor Lineup
- Selection Guide
- Outline
- Cylinder Type
- Square Type
- Capacitive Type

APS-S/M

APS-F/U

APS-10 to 15

Installation (Unit: mm)

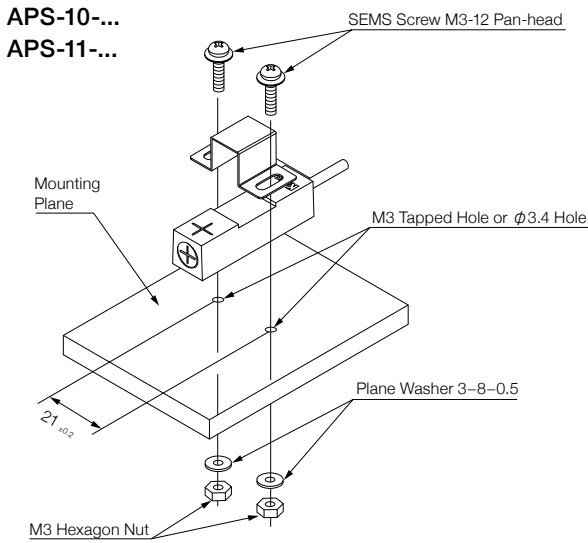

Dimensions (Unit: mm)

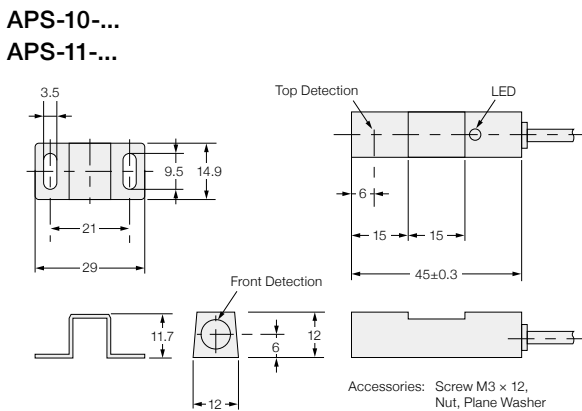

APS-12A-...

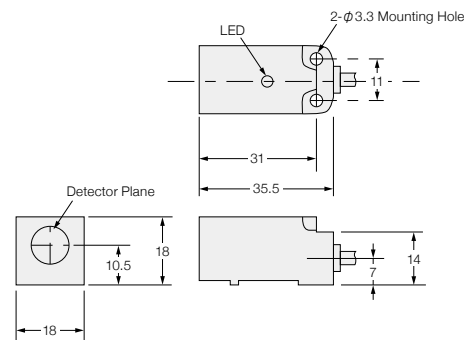

APS-13-4... APS-13-7...

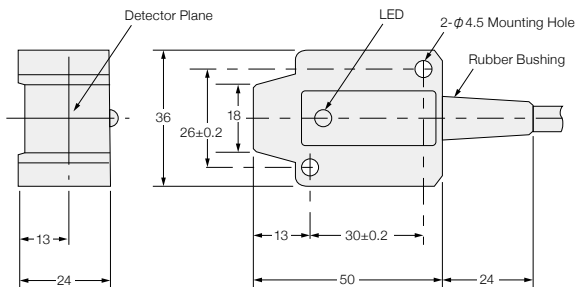

APS-14-... APS-15-...

