

APS-GK Series

Features

PBT Resin Cylinder, 3-wire DC System

- Models of different frequency are available for adjacent installation
- Offers reliable installation through stable detection range indicator
- Selectable between flush mount type / non-flush mount type
- NPN/PNP output



Type

3-wire DC System

Output Form		Operating Distance (mm)			Output Form	Model Number	Remarks
M12	Non-flush Mount Type	5			NPN NO	APS5-12GK-E	Different frequency-classified models are available. ("L" or "H" is attached to the end of model number.)
					PNP NO	APS5-12GK-E2	
M18	Non-flush Mount Type	10			NPN NO	APS10-18GK-E	
					PNP NO	APS10-18GK-E2	
M30	Non-flush Mount Type	18			NPN NO	APS18-30GK-E	

* Different frequency-classified models (H and L) are made-to-order products.

HMI

SENSOR

ENCODER

COUNTER

INFORMATION

Proximity
Sensor Lineup

Selection Guide

Outline

Cylinder Type

Square Type

Capacitive Type

APS-GMC

APS-GMD



APS-GK

APS-30/31

APS-CK

APS-GK Series

3-wire DC System Non-flush Mount Type

PLC HMI SENSOR ENCODER COUNTER INFORMATION Proximity
Sensor Lineup

Selection Guide

Outline

Cylinder Type

Square Type

Capacitive Type



APS-GMC

APS-GMD

APS-GK

APS-30/31

APS-CK

Effective Operating Distance		5 mm ±10%	10 mm ±10%	18 mm ±10%	
Photo					
Remarks		Different frequency-classified models are available. (Made-to-order products) With action indication	With action indication	With action indication	
Output Form	NPN NO	Model Number	APS5-12GK-E	APS10-18GK-E	APS18-30GK-E
		Price	Open	Open	Open
	PNP NO	Model Number	APS5-12GK-E2	APS10-18GK-E2	
		Price	Open	Open	
Rated Working Voltage		12/24 V DC (10 to 30 V DC) Allowable ripple rate: 10% p-p or less			
No-load Current		20 mA or lower			
Standard Target Object (mm)		Iron 15 x 15 x 1 t	Iron 30 x 30 x 1 t	Iron 54 x 54 x 1 t	
Guaranteed Operating Distance		0 to 4 mm	0 to 8 mm	0 to 14.5 mm	
Reaction Material		Iron/Non ferrous metal (Operating distance changes depending on materials.)			
Hysteresis		Approx. 20% or less			
Operating Cycle Frequency		400 Hz	200 Hz	100 Hz	
Rated Working Current		Up to 100 mA (12 V DC)/Up to 200 mA (24 V DC)			
Voltage Drop		1.5 V or lower (1.0 V TYP)			
Off-state Current		100 µA or less			
Indicator Lamp		Operation indication			
Use Ambient Temperature		-25 to +70°C			
Temperature Characteristics		Within ±10% (At the operating distance at +25°C)			
Withstand Voltage		500 V AC 50/60 Hz (1 minute)			
Insulation Resistance		50 MΩ or higher (500 V DC)			
Vibration Resistance		Double amplitude: 1.5 mm, 10 to 55 Hz (2 h each for X, Y and Z direction)			
Impact Resistance		600m/s ² , within 11 ms (10 times each for X, Y and Z direction)			
Protection Level		IP67			
Case Material		PBT resin			
Lead Wire		Oilproof vinyl chloride cable 1 m Outside diameter (Approx. φ3.5) 0.11 mm ² , 3 core	Oilproof vinyl chloride cable 1 m Outside diameter (Approx. φ6) 0.5 mm ² , 3 core		
Tightening Torque		1 Nm or less	2 Nm or less	3 Nm or less	
Weight (g)		Approx. 30	Approx. 70	Approx. 110	

"L" or "H" is attached to the end of model number of the various frequency-classified models. (Made-to-order product)

APS-GK Series

Connection and Operation

Connection/Operation

3-wire DC System NPN Output -E

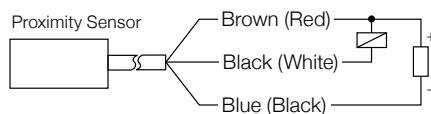

3-wire DC System PNP Output -E2

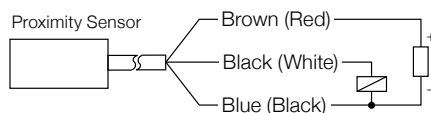

Note: indicates a load. Operation indication is only available for models having LED.

(Target Object Present Not Present)



Installation / Effects of Surrounding Metal

Since the proximity sensor is affected by surrounding metal, install it remotely enough from the described dimensions.

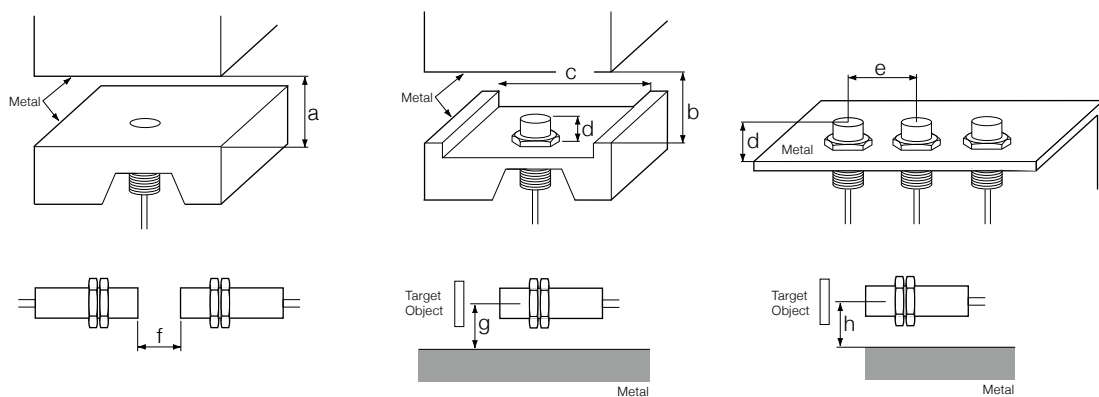

(Unit: mm)

Model Number	a	b	c	d	e	f	g	h
APS5-12GK	—	20	40	15	80	100	20	15
APS10-18GK	—	40	70	25	110	150	35	30
APS18-30GK	—	70	100	35	170	200	50	45

Mutual Interference and Frequency Classification

When two or more proximity sensors are closely installed, the installation interval of the sensors should be more than 10 times the operating distance (between centers).

If the interval is too short, mutual interference may occur. If the interval cannot be sufficiently secured, use modes with differently classified frequency.

The frequency classification is represented by the alphabet after the operating distance in the normal model number.

- Models with a classified frequency are shown by the mark on the cable.

- H : Yellow spiral
- L : Red spiral

(Example)

APS5-12GK-E (M) Model of standard frequency (M is not normally indicated.)

APS5-12GK-EL Model with lower frequency than the standard

APS5-12GK-EH Model with higher frequency than the standard

Combination of Models Classified by Frequency (The sensors can be mounted with the cases tightly attached.)

APS5-12GK-E(M)LH



* It requires consideration when 4 or more sensors are closely mounted.



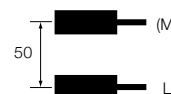



APS10-18GK-E(M)L



(Unit: mm)

APS-GK Series

Connection and Operation/Dimensions

- PLC 
- HMI 
- SENSOR** 
- ENCODER 
- COUNTER 
- INFORMATION 

- Proximity Sensor Lineup
- Selection Guide
- Outline
- Cylinder Type**
- Square Type
- Capacitive Type

- APS-GMC
- APS-GMD
- APS-GK**
- APS-30/31
- APS-CK

Detection Range Diagram (Representative Examples)

APS5-12GK-...

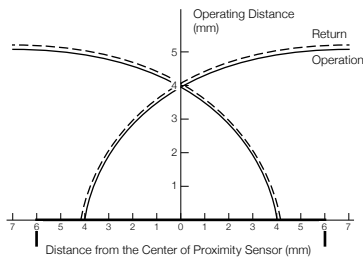

APS10-18GK-...

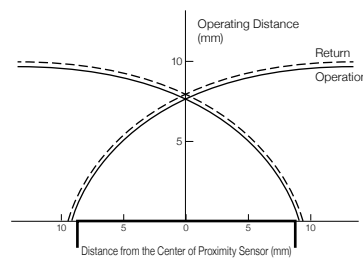

APS18-30GK-...

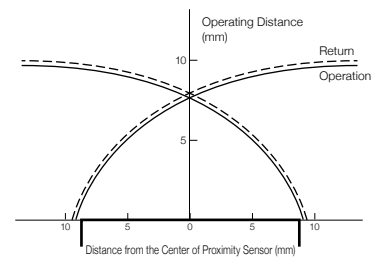

Shape Based Characteristics (Representative Examples)

APS5-12GK-...

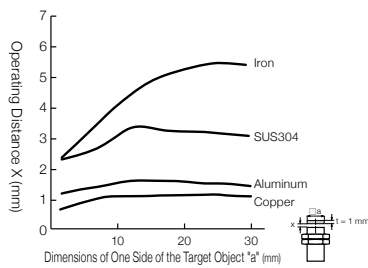

Dimensions (Unit: mm)

APS5-12GK-...

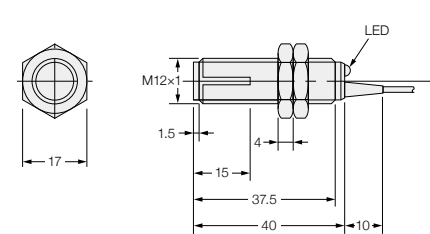

APS10-18GK-...

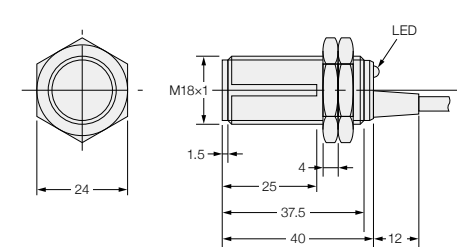

APS18-30GK-...

