



PROGRAMMABLE CONTROLLERS
MELSEC-F

FX2NC-485ADP

INSTALLATION MANUAL



Manual Number	JY997D01201
Revision	E
Date	April 2015

This manual contains text, diagrams and explanations which will guide the reader in the correct installation, safe use and operation of the FX2NC-485ADP (hereafter abbreviated to "485ADP") and should be read and understood before attempting to install or use the unit. Further information can be found in the associated manuals mentioned below.

Specifications are subject to change without notice.

Effective April 2015

Specifications are subject to change without notice.

© 2002 Mitsubishi Electric Corporation

Safety guidelines for the user and protection of the FX2NC-485ADP

This manual has been written to be used by trained and competent personnel. The definition of such a person or persons is as follows:

- Any engineer using the product associated with this manual, should be of a competent nature, trained and qualified to the local and national standards. These engineers should be fully aware of all aspects of safety with regards to automated equipment.
- Any commissioning or service engineer must be of a competent nature, trained and qualified to the local and national standards.
- All operators of the completed equipment should be trained to use this product in a safe and coordinated manner in compliance to established safety practices.

Note: The term "completed equipment" refers to a third party constructed device which contains or uses the product associated with this manual.

Notes on the Symbols Used in this Manual

At various times throughout this manual certain symbols will be used to highlight points of information which are intended to ensure the users personal safety and protect the integrity of equipment.



1) Indicates that the identified danger **WILL** cause physical and property damage.



2) Indicates that the identified danger could **POSSIBLY** cause physical and property damage.

- Under no circumstances will Mitsubishi Electric be liable or responsible for any consequential damage that may arise as a result of the installation or use of this equipment.
- All examples and diagrams shown in this manual are intended only as an aid to understanding the text, not to guarantee operation. Mitsubishi Electric will accept no responsibility for the actual use of the product based on these illustrative examples.
- Please contact a Mitsubishi distributor for more information concerning applications in life critical situations or high reliability.

Associated Manuals

★ Indispensable manual ☆ Either manual is necessary.

	Manual name	Manual Number	Description
This manual	FX2NC-485ADP INSTALLATION MANUAL	JY997D01201	Describes contents related to installation of the FX2NC-485ADP Module.
★	FX series User's Manual - Data Communication Edition	JY997D16901	Describes the various communications supported by FX PLCs.
☆	FX1S HARDWARE MANUAL	JY992D83901	Describes contents related to hardware of FX Series PLC such as specifications, wiring, and installation.
☆	FX0/FX0N HARDWARE MANUAL	JY992D47501	
☆	FX1N HARDWARE MANUAL	JY992D89301	
☆	FX2N HARDWARE MANUAL	JY992D66301	
☆	FX2NC HARDWARE MANUAL (DSS/DS)(D/DL)	JY992D76401 JY992D87201	
☆	PROGRAMMING MANUAL	JY992D76401	Describes contents related to instruction in FX0/FX0S/FX0N/FX1/FX2/FX2C Series PLC.
☆	PROGRAMMING MANUAL II	JY992D88101	Describes contents related to instruction in FX1S/FX1N/FX2N/FX2NC Series PLC.
☆	FX1N-CNV-BD Special Adapter Connection Board	JY992D84701	Describes contents related to installation of the each board.
☆	FX2N-CNV-BD Special Adapter Connection Board	JY992D63601	

1. Outline of Product

The 485ADP is an insulated RS-485 communication adapter with an European type terminal block. Connected to the main unit of the FX Series PLC, it enables signal exchange between the PLC and equipment via an RS-485 port.

2. Communication Functions and Applicable PLC (Available in indicated version or later)

Communication type	FX0N	FX1N FX1S	FX2N	FX2NC	Function
N:N network	V2.00	First product	V2.00	First product	Data transfer connecting up to eight FX Series PLCs.
Parallel link	V1.20	First product	V1.04	First product	Data transfer between two PLCs relationship specifying master/slave station.
Computer link	V1.20	First product	V1.06	First product	Data transfer via link protocol between PLC and computer (specified as the master station).
No protocol communication	V1.20	First product	V1.06	First product	Serial communication without protocol between PLC and equipment via RS-485 interface.
Inverter communication	—	—	V3.00	V3.00	Controlling Mitsubishi's FREQROL inverter using EXTR instruction in function expansion memory.

3. Installation



Caution

- Use in the environments specified under the general specification in the manual. Do not use the product in environments with excessive or conductive dust, corrosive or flammable gas, oily smoke, moisture or rain, excessive heat, regular impact shocks or excessive vibration, as it may result in electrical shock, fire, malfunction, damage or deterioration on the product.
- Make sure to shut off the power outside the product before installing or wiring it. Otherwise, electric shock or serious damage to the product may occur.
- Never drop wire chips or shavings into the vent slits when drilling screw holes or performing wiring, as they may cause fire, breakdown, or malfunction.
- Securely install the 485ADP to the designated port. Poor connection may cause malfunction.

3.1 How to Install to FX Series PLC

Installation to FX1S/FX1N/FX2N

Turn OFF the PLC before beginning any work.

- Remove the panel cover from the top face of the main unit.
- Take off the resin cover from the left side of the main unit.
- Install the following board to the port on the main unit.

Board name	Corresponding model
FX1N-CNV-BD	FX1N, FX1S
FX2N-CNV-BD	FX2N

- Fix the above board using the M3 screws supplied. Tightening torque: 0.3 to 0.6 N·m
- Connect the in-built cable of the 485ADP to the port on the board from the left side.

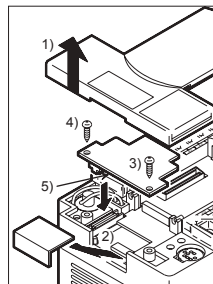

(FX2N in the diagram)

Installation to FX0N/FX2NC

Turn OFF the PLC before beginning any work.

- Remove the cover of the port for a special adapter provided on the left side of the main unit.
- Connect the in-built cable of the 485ADP to the port for a special adapter.

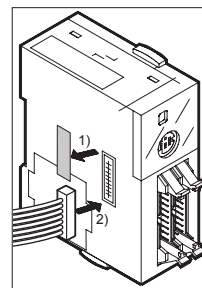

(FX2NC in the diagram)

3.2 How to Install to Panel Face

Direct installation to the panel face

Directly fix to the panel face using 2 sets of a screw (M4), a spring washer, and a flat washer in the mounting holes. Tightening torque: 0.7 to 1.0 N·m. For the pitch and positions of mounting screw holes, refer to the external dimensions.

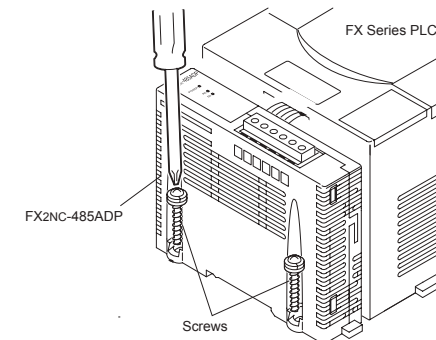

Mounting on DIN rail

Fix the 485ADP to the DIN rail, DIN46277 (35 mm (1.37") wide).

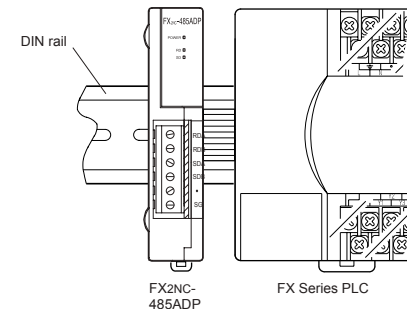

Dismounting from DIN rail

Slightly pull down the DIN rail mounting clip using a tool such as a slotted screwdriver. Pull down the clip further, and the rail will be locked with the clip left open.

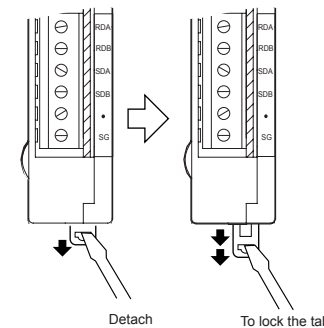

Industrial automation

Elincom Group

European Union: www.elinco.eu

Russia: www.elinc.ru

4. Product Specification

4.1 Specification

All other specifications than the followings are equivalent to those of the PLC main unit.

	Item	Specification
General specification	Withstand voltage	500V AC, 1 min (between terminal block and FX Series PLC main unit)
	Insulation resistance	5 MΩ or more, 500V DC by Megger (between terminal block and FX Series PLC main unit)
Power supply specification	Power supply voltage, current	5V DC (supplied from PLC main unit), max. 150 mA
Performance specification	Transmission standard	Conforming to RS-485/RS-422
	Type of isolation	Photo-coupler isolation
	Transmission distance	Total extension distance: 500 m or less (50 m or less if FX2N-485-BD or FX1N-485-BD is installed in connected equipment)
	Connection method	European type terminal block, AWG 26-16 (when inserting one twisted pair cable), AWG 26-20 (when inserting two twisted pair cables) Tightening torque: 0.4 to 0.5 N·m
	Number of occupied I/O points	0 point (unrelated to maximum number of controlled points of the PLC)
	Communication method	Half-duplex
	Baud rate	N:N network: 38400 bps, Parallel link: 19200bps Computer link, No protocol: 300/600/1200/2400/4800/9600/19200 bps
	Communication format	N:N network, Parallel link Computer (dedicated protocol: format 1/format 4), No protocol
	LED display (LED color)	Power: green, RD: red, SD: red

4.2 Outside Dimensions and Part Names

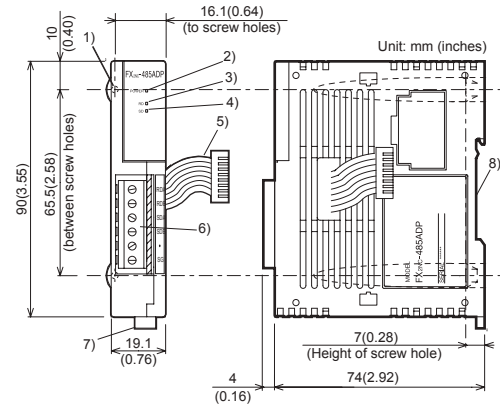

Weight: Approx. 0.1 kg (0.22 lbs)
 Color: Munsell 0.08GY 7.64/0.81
 DIN rail width: 35 mm (1.37")
 Accessories: Terminal resistors (330 W x 2 and 110 W x 1), Station number label for linking

- 1) Mounting hole 2- φ4.2 (0.16)
Used when mounting the 485ADP directly.
Not used when mounting the DIN rail.
- 2) POWER LED
Lit while 5V DC power is supplied from main unit.
- 3) RD LED
Lit while receiving data from connected equipment via RS-485 port.
- 4) SD LED
Lit while sending data to connected equipment via RS-485 port.
- 5) Cable
Used to connect to the main unit.
- 6) Terminal block for connecting RS-485 equipment (European type)
Used to connect RS-485 equipment to 485ADP.
- 7) DIN rail mounting clip
- 8) DIN rail mounting slot

4.3 Terminal configuration and recommended screwdriver

The terminal configuration of the RS-485 port on the 485ADP is as shown below.

Signal name	Function	Signal direction	
		485ADP	RS-485 equipment
RDA (RXD+)	Receive data		←
RDB (RXD-)			
SDA (TXD+)	Send data		→
SDB (TXD-)			
*	Not used	Do not wire.	
SG (GND)	Signal ground		—

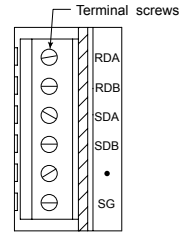

Recommended screwdriver to tighten terminal screws

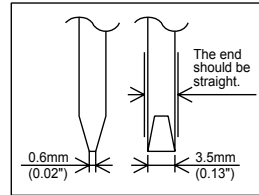

This manual confers no industrial property rights or any rights of any other kind, nor does it confer any patent licenses. Mitsubishi Electric Corporation cannot be held responsible for any problems involving industrial property rights which may occur as a result of using the contents noted in this manual.

Attention

- This product is designed for use in industrial applications.

Note

- Authorized Representative in the European Community:
Mitsubishi Electric Europe B.V.
Gothaer Str. 8, 40880 Ratingen, Germany

Warranty

Mitsubishi will not be held liable for damage caused by factors found not to be the cause of Mitsubishi; opportunity loss or lost profits caused by faults in the Mitsubishi products; damage, secondary damage, accident compensation caused by special factors unpredictable by Mitsubishi; damages to products other than Mitsubishi products; and to other duties.

For safe use

- This product has been manufactured as a general-purpose part for general industries, and has not been designed or manufactured to be incorporated in a device or system used in purposes related to human life.
- Before using the product for special purposes such as nuclear power, electric power, aerospace, medicine or passenger movement vehicles, consult with Mitsubishi Electric.
- This product has been manufactured under strict quality control. However when installing the product where major accidents or losses could occur if the product fails, install appropriate backup or failsafe functions in the system.

MITSUBISHI ELECTRIC CORPORATION

HEAD OFFICE : TOKYO BUILDING, 2-7-3 MARUNOUCHI, CHIYODA-KU, TOKYO 100-8310, JAPAN



PROGRAMMABLE CONTROLLERS
MELSEC-F

FX2NC-485ADP INSTALLATION MANUAL



Manual Number	JY997D01201
Revision	E
Date	April 2015

This manual contains text, diagrams and explanations which will guide the reader in the correct installation, safe use and operation of the FX2NC-485ADP (hereafter abbreviated to "485ADP") and should be read and understood before attempting to install or use the unit. Further information can be found in the associated manuals mentioned below.
Specifications are subject to change without notice.

Effective April 2015
Specifications are subject to change without notice.
© 2002 Mitsubishi Electric Corporation

Safety guidelines for the user and protection of the FX2NC-485ADP

This manual has been written to be used by trained and competent personnel. The definition of such a person or persons is as follows:

- Any engineer using the product associated with this manual, should be of a competent nature, trained and qualified to the local and national standards. These engineers should be fully aware of all aspects of safety with regards to automated equipment.
- Any commissioning or service engineer must be of a competent nature, trained and qualified to the local and national standards.
- All operators of the completed equipment should be trained to use this product in a safe and coordinated manner in compliance to established safety practices.

Note: The term "completed equipment" refers to a third party constructed device which contains or uses the product associated with this manual.

Notes on the Symbols Used in this Manual

At various times throughout this manual certain symbols will be used to highlight points of information which are intended to ensure the users personal safety and protect the integrity of equipment.

1) Indicates that the identified danger **WILL** cause physical and property damage.

2) Indicates that the identified danger could **POSSIBLY** cause physical and property damage.

- Under no circumstances will Mitsubishi Electric be liable or responsible for any consequential damage that may arise as a result of the installation or use of this equipment.
- All examples and diagrams shown in this manual are intended only as an aid to understanding the text, not to guarantee operation. Mitsubishi Electric will accept no responsibility for the actual use of the product based on these illustrative examples.
- Please contact a Mitsubishi distributor for more information concerning applications in life critical situations or high reliability.

Associated Manuals

* Indispensable manual ☆ Either manual is necessary.

	Manual name	Manual Number	Description
This manual	FX2NC-485ADP INSTALLATION MANUAL	JY997D01201	Describes contents related to installation of the FX2NC-485ADP Module.
★	FX series User's Manual - Data Communication Edition	JY997D16901	Describes the various communications supported by FX PLCs.
☆	FX1S HARDWARE MANUAL	JY992D83901	Describes contents related to hardware of FX Series PLC such as specifications, wiring, and installation.
☆	FX0/FX0N HARDWARE MANUAL	JY992D47501	
☆	FX1N HARDWARE MANUAL	JY992D89301	
☆	FX2N HARDWARE MANUAL	JY992D66301	
☆	FX2NC HARDWARE MANUAL (DSS/DS/DIUL)	JY992D76401 JY992D87201	
☆	PROGRAMMING MANUAL	JY992D76401	Describes contents related to instruction in FX0/FX0S/FX0N/FX1/FX2/FX2C Series PLC.
☆	PROGRAMMING MANUAL II	JY992D88101	Describes contents related to instruction in FX1S/FX1N/FX2N/FX2NC Series PLC.
☆	FX1N-CNV-BD Special Adapter Connection Board	JY992D84701	Describes contents related to installation of the each board.
☆	FX2N-CNV-BD Special Adapter Connection Board	JY992D63601	

1. Outline of Product

The 485ADP is an insulated RS-485 communication adapter with an European type terminal block. Connected to the main unit of the FX Series PLC, it enables signal exchange between the PLC and equipment via an RS-485 port.

2. Communication Functions and Applicable PLC (Available in indicated version or later)

Communication type	FX0N	FX1N FX1S	FX2N	FX2NC	Function
N:N network	V2.00	First product	V2.00	First product	Data transfer connecting up to eight FX Series PLCs.
Parallel link	V1.20	First product	V1.04	First product	Data transfer between two PLCs relationship specifying master/slave station.
Computer link	V1.20	First product	V1.06	First product	Data transfer via link protocol between PLC and computer (specified as the master station).
No protocol communication	V1.20	First product	V1.06	First product	Serial communication without protocol between PLC and equipment via RS-485 interface.
Inverter communication	—	—	V3.00	V3.00	Controlling Mitsubishi's FREQROL inverter using EXTR instruction in function expansion memory.

3. Installation

Caution

- Use in the environments specified under the general specification in the manual.
 - Do not use the product in environments with excessive or conductive dust, corrosive or flammable gas, oily smoke, moisture or rain, excessive heat, regular impact shocks or excessive vibration, as it may result in electrical shock, fire, malfunction, damage or deterioration on the product.
 - Make sure to shut off the power outside the product before installing or wiring it.
 - Otherwise, electric shock or serious damage to the product may occur.
 - Never drop wire chips or shavings into the vent slits when drilling screw holes or performing wiring, as they may cause fire, breakdown, or malfunction.
 - Securely install the 485ADP to the designated port.
- Poor connection may cause malfunction.

3.1 How to Install to FX Series PLC

Installation to FX1S/FX1N/FX2N

- Turn OFF the PLC before beginning any work.
- Remove the panel cover from the top face of the main unit.
- Take off the resin cover from the left side of the main unit.
- Install the following board to the port on the main unit.

Board name	Corresponding model
FX1N-CNV-BD	FX1N, FX1S
FX2N-CNV-BD	FX2N

- Fix the above board using the M3 screws supplied.
- Tightening torque: 0.3 to 0.6 N·m
- Connect the in-built cable of the 485ADP to the port on the board from the left side.

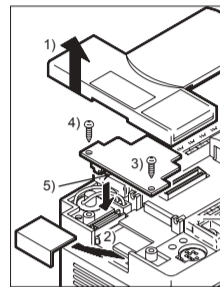

Installation to FX0N/FX2NC

Turn OFF the PLC before beginning any work.

- Remove the cover of the port for a special adapter provided on the left side of the main unit.
- Connect the in-built cable of the 485ADP to the port for a special adapter.

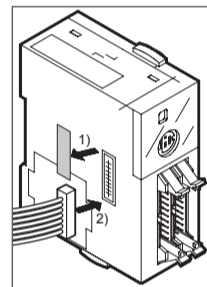

3.2 How to Install to Panel Face

Direct installation to the panel face

Directly fix to the panel face using 2 sets of a screw (M4), a spring washer, and a flat washer in the mounting holes. Tightening torque: 0.7 to 1.0 N·m. For the pitch and positions of mounting screw holes, refer to the external dimensions.

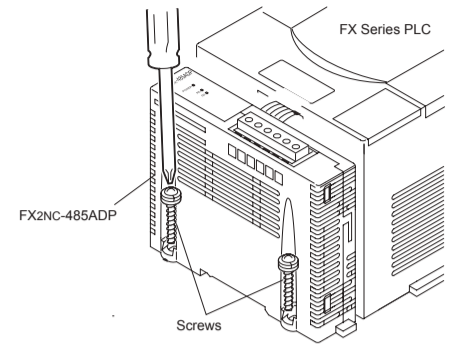

Mounting on DIN rail

Fix the 485ADP to the DIN rail, DIN46277 (35 mm (1.37") wide).

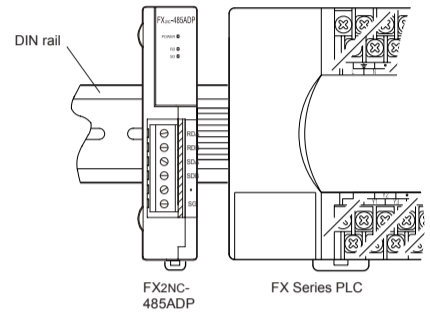

Dismounting from DIN rail

Slightly pull down the DIN rail mounting clip using a tool such as a slotted screwdriver. Pull down the clip further, and the rail will be locked with the clip left open.

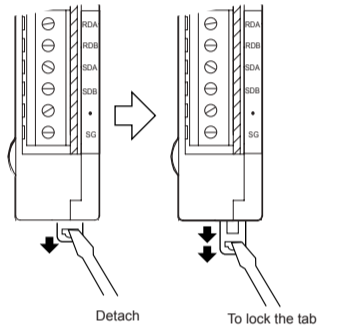

4. Product Specification

4.1 Specification

All other specifications than the followings are equivalent to those of the PLC main unit.

	Item	Specification
General specification	Withstand voltage	500V AC, 1 min (between terminal block and FX Series PLC main unit)
	Insulation resistance	5 MΩ or more, 500V DC by Megger (between terminal block and FX Series PLC main unit)
Power supply specification	Power supply voltage, current	5V DC (supplied from PLC main unit), max. 150 mA
	Transmission standard	Conforming to RS-485/RS-422
Performance specification	Type of isolation	Photo-coupler isolation
	Transmission distance	Total extension distance: 500 m or less (50 m or less if FX2N-485-BD or FX1N-485-BD is installed in connected equipment)
	Connection method	European type terminal block, AWG 26-16 (when inserting one twisted pair cable), AWG 26-20 (when inserting two twisted pair cables) Tightening torque: 0.4 to 0.5 N·m
	Number of occupied I/O points	0 point (unrelated to maximum number of controlled points of the PLC)
	Communication method	Half-duplex
	Baud rate	N:N network: 38400 bps, Parallel link: 19200bps Computer link, No protocol: 300/600/1200/2400/4800/9600/19200 bps
	Communication format	N:N network, Parallel link Computer (dedicated protocol: format 1/format 4), No protocol
LED display (LED color)	Power: green, RD: red, SD: red	

4.3 Terminal configuration and recommended screwdriver

The terminal configuration of the RS-485 port on the 485ADP is as shown below.

Signal name	Function	Signal direction	
		485ADP	RS-485 equipment
RDA (RXD+)	Receive data		←
RDB (RXD-)			←
SDA (TXD+)	Send data		→
SDB (TXD-)			→
*	Not used		Do not wire.
SG (GND)	Signal ground		—

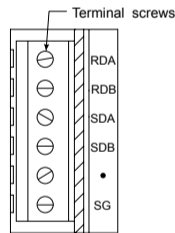

Recommended screwdriver to tighten terminal screws

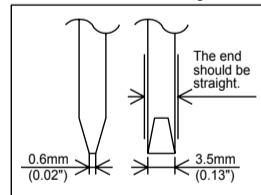

4.2 Outside Dimensions and Part Names

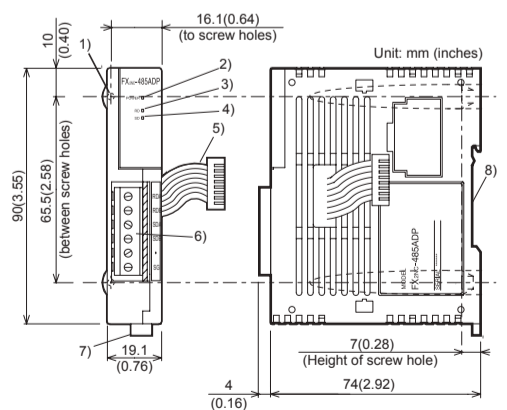

Weight: Approx. 0.1 kg (0.22 lbs)
Color: Munsell 0.08GY 7.64/0.81
DIN rail width: 35 mm (1.37")
Accessories: Terminal resistors (330 Ω x 2 and 110 Ω x 1), Station number label for linking

- Mounting hole 2-φ4.2 (0.16)
Used when mounting the 485ADP directly.
Not used when mounting the DIN rail.
- POWER LED
Lit while 5V DC power is supplied from main unit.
- RD LED
Lit while receiving data from connected equipment via RS-485 port.
- SD LED
Lit while sending data to connected equipment via RS-485 port.
- Cable
Used to connect to the main unit.
- Terminal block for connecting RS-485 equipment (European type)
Used to connect RS-485 equipment to 485ADP.
- DIN rail mounting clip
- DIN rail mounting slot

This manual confers no industrial property rights or any rights of any other kind, nor does it confer any patent licenses. Mitsubishi Electric Corporation cannot be held responsible for any problems involving industrial property rights which may occur as a result of using the contents noted in this manual.

Attention

* This product is designed for use in industrial applications.

Note

* Authorized Representative in the European Community:
Mitsubishi Electric Europe B.V.
Gothaer Str. 8, 40880 Ratingen, Germany

Warranty

Mitsubishi will not be held liable for damage caused by factors found not to be the cause of Mitsubishi; opportunity loss or lost profits caused by faults in the Mitsubishi products; damage, secondary damage, accident compensation caused by special factors unpredictable by Mitsubishi; damages to products other than Mitsubishi products; and to other duties.

For safe use

- This product has been manufactured as a general-purpose part for general industries, and has not been designed or manufactured to be incorporated in a device or system used in purposes related to human life.
- Before using the product for special purposes such as nuclear power, electric power, aerospace, medicine or passenger movement vehicles, consult with Mitsubishi Electric.
- This product has been manufactured under strict quality control. However when installing the product where major accidents or losses could occur if the product fails, install appropriate backup or failsafe functions in the system.

MITSUBISHI ELECTRIC CORPORATION

HEAD OFFICE : TOKYO BUILDING, 2-7-3 MARUNOUCHI, CHYODA-KU, TOKYO 100-8310, JAPAN