



PROGRAMMABLE CONTROLLERS  
MELSEC-F

FX3UC (D, DS, DSS) SERIES  
PROGRAMMABLE CONTROLLERS

HARDWARE MANUAL



Manual Number	JY997D50501
Revision	D
Date	September 2016

This manual describes the part names, dimensions, mounting, cabling and specifications for the product. This manual is extracted from FX3UC (D,DS,DSS) Series User's Manual - Hardware Edition. Refer to FX3UC Series User's Manual - Hardware Edition details. Before use, read this manual and manuals of relevant products fully to acquire proficiency in the handling and operating the product. Make sure to learn all the product information, safety information, and precautions.

And, store this manual in a safe place so that it can be taken out and read whenever necessary. Always forward it to the end user.

Registration  
The company name and the product name to be described in this manual are the registered trademarks or trademarks of each company.

Effective September 2016

Specifications are subject to change without notice.

© 2013 Mitsubishi Electric Corporation

Safety Precaution (Read these precautions before use.)

This manual classifies the safety precautions into two categories:

⚠ WARNING and ⚠ CAUTION .

	Indicates that incorrect handling may cause hazardous conditions, resulting in death or severe injury.
	Indicates that incorrect handling may cause hazardous conditions, resulting in medium or slight personal injury or physical damage.

Depending on the circumstances, procedures indicated by

⚠ CAUTION may also cause severe injury.

It is important to follow all precautions for personal safety.

Industrial automation

Elincom Group

European Union: [www.elinco.eu](http://www.elinco.eu)

Russia: [www.elinc.ru](http://www.elinc.ru)

**STARTUP AND MAINTENANCE PRECAUTIONS** ⚠ WARNING

- Do not touch any terminal while the PLC's power is on. Doing so may cause electric shock or malfunctions.
- Before cleaning or retightening terminals, cut off all phases of the power supply externally. Failure to do so may cause electric shock.
- Before modifying or disrupting the program in operation or running the PLC, carefully read through this manual and the associated manuals and ensure the safety of the operation. An operation error may damage the machinery or cause accidents.
- Do not change the program in the PLC from two or more peripheral equipment devices at the same time. (i.e. from a programming tool and a GOT) Doing so may cause destruction or malfunction of the PLC program.
- Use the battery for memory backup correctly in FX3UC Series User's Manual - Hardware Edition.
  - Use the battery only for the specified purpose.
  - Connect the battery correctly.
  - Do not charge, disassemble, heat, put in fire, short-circuit, connect reversely, weld, swallow or burn the battery, or apply excessive forces (vibration, impact, drop, etc.) to the battery.
  - Do not store or use the battery at high temperatures or expose to direct sunlight.
  - Do not expose to water, bring near fire or touch liquid leakage or other contents directly.
  - Incorrect handling of the battery may cause heat excessive generation, bursting, ignition, liquid leakage or deformation, and lead to injury, fire or failures and malfunctions of facilities and other equipment.

**STARTUP AND MAINTENANCE PRECAUTIONS** ⚠ CAUTION

- Turn off the power to the PLC before attaching or detaching the memory cassette. If the memory cassette is attached or detached while the PLC's power is on, the data in the memory may be destroyed, or the memory cassette may be damaged.
- Do not disassemble or modify the PLC. Doing so may cause fire, equipment failures, or malfunctions. For repair, contact your local Mitsubishi Electric representative.
- Turn off the power to the PLC before connecting or disconnecting any extension cable. Failure to do so may cause equipment failures or malfunctions.
- Turn off the power to the PLC before attaching or detaching the following devices. Failure to do so may cause equipment failures or malfunctions.
  - Peripheral devices, extension units/blocks, connector conversion adapter, extension power supply units, special adapters, and FX Series terminal blocks.
  - Battery and memory cassettes

**DISPOSAL PRECAUTIONS** ⚠ CAUTION

- Please contact a certified electronic waste disposal company for the environmentally safe recycling and disposal of your device. When disposing of batteries, separate them from other waste according to local regulations. (For details of the Battery Directive in EU countries, refer to FX3UC Series User's Manual - Hardware Edition.)

**TRANSPORTATION AND STORAGE PRECAUTIONS** ⚠ CAUTION

- Before transporting the PLC, turn on the power to the PLC to check that the BAT LED is off, and check the battery life. If the PLC is transported with the BAT LED on or the battery exhausted, the battery-backed data may be unstable during transportation.
- The PLC is a precision instrument. During transportation, avoid impacts larger than those specified in Section 2.1 by using dedicated packaging boxes and shock-absorbing pallets. Failure to do so may cause failures in the PLC. After transportation, verify operation of the PLC and check for damage of the mounting part, etc.
- When transporting lithium batteries, follow required transportation regulations. (For details of the regulated products, refer to FX3UC Series User's Manual - Hardware Edition.)

Associated manuals

How to obtain manuals
For the necessary product manuals or documents, consult with your local Mitsubishi Electric representative.

Associated manuals

FX3UC (D, DS, DSS) Series PLC (main unit) comes with this document (hardware manual).

For a detailed explanation of the FX3UC Series hardware and information on instructions for PLC programming and special extension unit/block, refer to the relevant documents.

Manual name	Manual No.	Description
FX3UC Series User's Manual - Hardware Edition	JY997D28701 MODEL CODE: 09R519	Explains FX3UC Series PLC specification details for I/O, wiring, installation, and maintenance.
FX3S/FX3G/FX3GC/FX3U/FX3UC Series Programming Manual - Basic & Applied Instruction Edition	JY997D16601 MODEL CODE: 09R517	Describes PLC programming for basic/applied instructions STL/SFC programming and devices.
MELSEC-Q/L/F Structured Programming Manual (Fundamentals)	SH-080782 MODEL CODE: 13JW06	Programming methods, specifications, functions, etc. required to create structured programs.
FXCPU Structured Programming Manual [Device & Common]	JY997D26001 MODEL CODE: 09R925	Devices, parameters, etc. provided in structured projects of GX Works2.
FXCPU Structured Programming Manual [Basic & Applied Instruction]	JY997D34701 MODEL CODE: 09R926	Sequence instructions provided in structured projects of GX Works2.
FXCPU Structured Programming Manual [Application Functions]	JY997D34801 MODEL CODE: 09R927	Application functions provided in structured projects of GX Works2.
FX Series User's Manual - Data Communication Edition	JY997D16901 MODEL CODE: 09R715	Explains N:N link, parallel link, computer link, no protocol communication by RS instructions/FX2N-232IF.

Manual name	Manual No.	Description
FX3S/FX3G/FX3GC/FX3U/FX3UC Series User's Manual - Analog Control Edition	JY997D16701 MODEL CODE: 09R619	Describes specifications for analog control and programming methods for FX3S/FX3G/FX3GC/FX3U/FX3UC Series PLC.
FX3S/FX3G/FX3GC/FX3U/FX3UC Series User's Manual - Positioning Control Edition	JY997D16801 MODEL CODE: 09R620	Explains the specifications for positioning control of FX3S/FX3G/FX3GC/FX3U/FX3UC Series and programming procedures

Certification of UL, cUL standards

FX3UC series main units, FX3U series special adapter, extension power supply unit and FX2N/FX2NC series input/output extension blocks supporting UL, cUL standards are as follows:

UL, cUL file number: E95239

Models: MELSEC FX3U(c) series manufactured

FX3UC-★ ★ MT/D FX3UC-★ ★ MT/DSS  
Where ★ ★ indicates: 16, 32, 64, 96

FX3UC-16MR/D-T FX3UC-16MR/DS-T  
FX3U-232ADP(-MB) FX3U-485ADP(-MB)  
FX3U-CF-ADP FX3U-ENET-ADP  
FX3U-4AD-ADP FX3U-4DA-ADP  
FX3U-3A-ADP FX3U-4AD-PT-ADP  
FX3U-4AD-PTW-ADP FX3U-4AD-PNK-ADP  
FX3U-4AD-TC-ADP  
FX3UC-1PS-5V

Models: MELSEC FX2NC series manufactured

FX2NC-16EX(-DS) FX2NC-32EX(-DS)  
FX2NC-16EYT(-DSS) FX2NC-32EYT(-DSS)  
FX2NC-16EX-T(-DS) FX2NC-16EYT-T(-DS)

Models: MELSEC FX2N series manufactured

FX2N-8ER-ES/UL FX2N-8EX-ES/UL  
FX2N-8EYR-ES/UL FX2N-8EYR-S-ES/UL  
FX2N-8EYT-ESS/UL FX2N-8EX-UA1/UL  
FX2N-16EX-ES/UL FX2N-16EYR-ES/UL  
FX2N-16EYT-ESS/UL FX2N-16EYS

Compliance with EC directive (CE Marking)

This document does not guarantee that a mechanical system including this product will comply with the following standards. Compliance to EMC directive and LVD directive of the entire mechanical system should be checked by the user / manufacturer. For more details please contact the local Mitsubishi Electric sales site.

Requirement for Compliance with EMC directive

The following products have shown compliance through direct testing (of the identified standards below) and design analysis (through the creation of a technical construction file) to the European Directive for Electromagnetic Compatibility (2014/30/EU) when used as directed by the appropriate documentation.

Attention

This product is designed for use in industrial applications.

**Type: Programmable Controller (Open Type Equipment)**  
**Models: MELSEC FX3U(c) series and FX2C series manufactured**

from May 1st, 2005	FX3U-FLROM-16	FX3U-FLROM-64L
from June 1st, 2005	FX3U-232ADP	FX3U-485ADP
	FX3U-4AD-ADP	FX3U-4DA-ADP
	FX3U-4AD-PT-ADP	FX3U-4AD-TC-ADP
	FX3U-FLROM-64	
from April 1st, 2007	FX3U-232ADP-MB	FX3U-485ADP-MB
from September 1st, 2007	FX3UC-★MT/D	FX3UC-★MT/DSS
	Where ★★ indicates: 16, 32, 64, 96	
from October 1st, 2007	FX3UC-1PS-5V	
	FX2NC-★EX	FX2NC-★EYT
	FX2NC-★EX-DS	FX2NC-★EYT-DSS
	Where ★★ indicates: 16, 32	
	FX2NC-16EX-T	FX2NC-16EX-T-DS
from December 1st, 2007	FX3U-4AD-PTW-ADP	FX3U-4AD-PNK-ADP
from June 1st, 2009	FX3U-3A-ADP	FX3U-CF-ADP
from September 1st, 2010	FX3UC-16MR/D-T	FX3UC-16MR/DS-T
from May 1st, 2011	FX3U-FLROM-1M	
from February 1st, 2012	FX3U-ENET-ADP	

Standard	Remark
EN61131-2: 2007 Programmable controllers - Equipment requirements and tests	Compliance with all relevant aspects of the standard. EMI <ul style="list-style-type: none"> <li>• Radiated Emission</li> <li>• Conducted Emission</li> </ul> EMS <ul style="list-style-type: none"> <li>• Radiated electromagnetic field</li> <li>• Fast transient burst</li> <li>• Electrostatic discharge</li> <li>• High-energy surge</li> <li>• Voltage drops and interruptions</li> <li>• Conducted RF</li> <li>• Power frequency magnetic field</li> </ul>

**Models: MELSEC FX2NC series manufactured**

from March 1st, 1999	FX2NC-★EX-DS	FX2NC-★EYT-DSS
	Where ★★ indicates: 16, 32	
from August 1st, 1999	FX2NC-16EX-T-DS	FX2NC-16EYR-T-DS
from October 1st, 2007	FX2NC-★EX	FX2NC-★EYT
	Where ★★ indicates: 16, 32	
	FX2NC-16EX-T	FX2NC-16EYR-T

Standard	Remark
EN61000-6-4: 2007 - Generic emission standard Industrial environment EN50081-2: 1993 Electromagnetic compatibility	Compliance with all relevant aspects of the standard. <ul style="list-style-type: none"> <li>• Emission-Enclosure port</li> <li>• Emission-Low voltage AC mains port</li> <li>• Emission-Telecommunications/network port</li> </ul>
EN61000-6-2: 2005 - Generic immunity standard Industrial environment	Compliance with all relevant aspects of the standard. <ul style="list-style-type: none"> <li>• Radio-frequency electromagnetic field. Amplitude modulated</li> <li>• Fast transients</li> <li>• Electrostatic discharge</li> <li>• Surges</li> <li>• Voltage dips</li> <li>• Voltage interruptions</li> <li>• Radio-frequency common mode</li> <li>• Power-frequency magnetic field</li> </ul>

**Models: MELSEC FX2N series manufactured**

from July 1st, 1997	FX2N-16EX-ES/UL	FX2N-16EYR-ES/UL
	FX2N-16EYT-ESS/UL	
from August 1st, 2005	FX2N-8ER-ES/UL	FX2N-8EX-ES/UL
	FX2N-8EYR-ES/UL FX2N-8EYT-ESS/UL	
from September 1st, 2010	FX2N-8EYR-S-ES/UL	

For the products above, PLC's manufactured before March 31st, 2002 are compliant with EN50081-2 (EN61000-6-4) and EN50082-2 only.

PLC's manufactured from April 1st, 2002 to April 30th, 2006 are compliant with EN50081-2 (EN61000-6-4) and EN61131-2: 1994 +A11: 1996 +A12: 2000  
 PLC's manufactured after May 1st, 2006 are compliant with EN61131-2: 2007

Standard	Remark
EN61000-6-4: 2007 - Generic emission standard Industrial environment EN50081-2: 1993 Electromagnetic compatibility	Compliance with all relevant aspects of the standard. <ul style="list-style-type: none"> <li>• Emission-Enclosure port</li> <li>• Emission-Low voltage AC mains port</li> <li>• Emission-Telecommunications/network port</li> </ul>
EN50082-2: 1995 Electromagnetic compatibility - Generic immunity standard Industrial environment	Compliance with all relevant aspects of the standard. <ul style="list-style-type: none"> <li>• RF immunity</li> <li>• Fast Transients</li> <li>• ESD</li> <li>• Conducted</li> <li>• Power magnetic fields</li> </ul>
EN61131-2: 1994 /A11: 1996 /A12: 2000 Programmable controllers - Equipment requirements and tests	Compliance with all relevant aspects of the standard. <ul style="list-style-type: none"> <li>• Radiated electromagnetic field</li> <li>• Fast transient burst</li> <li>• Electrostatic discharge</li> <li>• Damped oscillatory wave</li> </ul>
EN61131-2: 2007 Programmable controllers - Equipment requirements and tests	Compliance with all relevant aspects of the standard. EMI <ul style="list-style-type: none"> <li>• Radiated Emission</li> <li>• Conducted Emission</li> </ul> EMS <ul style="list-style-type: none"> <li>• Radiated electromagnetic field</li> <li>• Fast transient burst</li> <li>• Electrostatic discharge</li> <li>• High-energy surge</li> <li>• Voltage drops and interruptions</li> <li>• Conducted RF</li> <li>• Power frequency magnetic field</li> </ul>

**Requirement for Compliance with LVD directive**

The following products have shown compliance through direct testing (of the identified standards below) and design analysis (through the creation of a technical construction file) to the European Directive for Low Voltage (2014/35/EU) when used as directed by the appropriate documentation.

**Type: Programmable Controller (Open Type Equipment)**  
**Models: MELSEC FX3UC series manufactured**

from September 1st, 2010	FX3UC-16MR/D-T	FX3UC-16MR/DS-T
--------------------------	----------------	-----------------

Standard	Remark
EN61131-2: 2007 Programmable controllers - Equipment requirements and tests	The equipment has been assessed as a component for fitting in a suitable enclosure which meets the requirements of EN61131-2: 2007

**Models: MELSEC FX2NC series manufactured**

from August 1st, 1999	FX2NC-16EYR-T-DS
from October 1st, 2007	FX2NC-16EYR-T

Standard	Remark
IEC1010-1: 1990 /A1: 1992 BSEN61010-1: 1993 (*)	The equipment has been assessed as a component for fitting in a suitable enclosure which meets the requirements of IEC 1010-1: 1990 +A1: 1992
Safety requirements for electrical equipment for measurement, control, and laboratory use - General requirements	

(\*) Compliance to BSEN61010-1 is claimed through virtue of direct compliance to IEC1010-1 and Amendment 1.

**Models: MELSEC FX2N series manufactured**

from July 1st, 1997	FX2N-16EYR-ES/UL
from August 1st, 2005	FX2N-8ER-ES/UL FX2N-8EYR-ES/UL
from September 1st, 2010	FX2N-8EYR-S-ES/UL

For the products above, PLC's manufactured before March 31st, 2002 are compliant with IEC1010-1  
 PLC's manufactured from April 1st, 2002 to April 30th, 2006 are compliant with EN61131-2: 1994 +A11: 1996 +A12: 2000  
 PLC's manufactured after May 1st, 2006 are compliant with EN61131-2: 2007

Standard	Remark
IEC1010-1: 1990 /A1: 1992 Safety requirements for electrical equipment for measurement, control, and laboratory use - General requirements	The equipment has been assessed as a component for fitting in a suitable enclosure which meets the requirements of IEC 1010-1: 1990 +A1: 1992
EN61131-2: 1994 : 2007 /A12: 2000 /A11: 1996 Programmable controllers - Equipment requirements and tests	The equipment has been assessed as a component for fitting in a suitable enclosure which meets the requirements of EN61131-2: 1994 +A11: 1996 +A12: 2000 : 2007

**Caution for Compliance with EC directive**

**Installation in Enclosure**

Programmable logic controllers are open-type devices that must be installed and used within conductive control boxes. Please use the FX3UC (D, DS, DSS) Series programmable logic controllers while installed in conductive shielded control boxes. Please secure the control box lid to the control box (for conduction). Installation within a control box greatly affects the safety of the system and aids in shielding noise from the programmable logic controller.

**Caution for Analog Products in use**

The analog special adapters have been found to be compliant to the European standards in the aforesaid manual and directive. However, for the very best performance from what are in fact delicate measuring and controlled output device Mitsubishi Electric would like to make the following points;

As analog devices are sensitive by nature, their use should be considered carefully. For users of proprietary cables (integral with sensors or actuators), these users should follow the manufacturers' installation requirements.

Mitsubishi Electric recommends that shielded cables be used. If no other EMC protection is provided, then users may experience temporary loss of accuracy between +10 %/-10 % in very heavy industrial areas.

However, Mitsubishi Electric suggests that when adequate EMC precautions are followed with general good EMC practice for the users complete control system.

- Sensitive analog cables should not be laid next to or bound with high voltage cabling. Where possible, users should run analog cables separately.
- Good cable shielding should be used. When grounding the shield - ensure that no loops are accidentally created.
- When reading analog values, EMC induced errors can be smoothed out by averaging the readings. This can be achieved either through functions on the analog special adapter/block or through the user's program in the FX3UC Series PLC main unit.

**Incorporated Items**

Verify that the following product and items are included in the package.

	Included Items	
■ Main units	Product	1 unit
	FX2NC-100MPCB [1 m (3' 3"), three wire]	1 cable
	FX2NC-100BPCB [1 m (3' 3"), two wire]	1 cable
	Manuals [Japanese/English]	1 manual
FX3UC-□□MT/D FX3UC-16MR/D-T	Product	1 unit
	FX2NC-100MPCB [1 m (3' 3"), three wire]	1 cable
FX3UC-□□MT/DSS FX3UC-16MR/DS-T	Product	1 unit
	FX2NC-100MPCB [1 m (3' 3"), three wire]	1 cable
■ Input/output extension blocks	Product	1 unit
	FX2NC-□□EX FX2NC-16EX-T	FX2NC-10BPCB1 [0.1 m (3.93"), double-ended]
FX2NC-□□EX-DS FX2NC-16EX-T-DS FX2NC-□□EYT FX2NC-□□EYT-DSS FX2NC-16EYR-T FX2NC-16EYR-T-DS	Product	1 unit

**1. Outline**

**1.1 Part names**

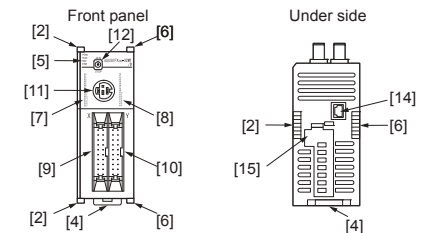

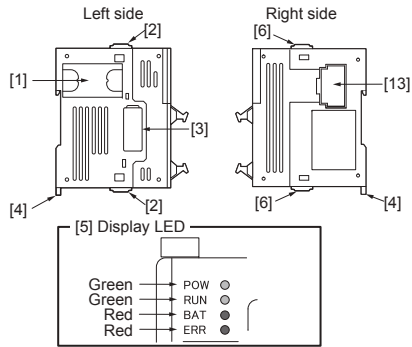

No.	Name								
[1]	Memory cassette dummy cover								
[2]	Special adapter connecting hooks								
[3]	Special adapter connector cover								
[4]	DIN rail mounting hooks								
[5]	<table border="0"> <tr> <td>POW LED</td> <td>On while power is on the PLC.</td> </tr> <tr> <td>RUN LED</td> <td>On while the PLC is running.</td> </tr> <tr> <td>BAT LED</td> <td>Lights when the battery voltage drops.</td> </tr> <tr> <td>ERR LED</td> <td>Flashing when a program error occurs. Lights when a CPU error occurs.</td> </tr> </table>	POW LED	On while power is on the PLC.	RUN LED	On while the PLC is running.	BAT LED	Lights when the battery voltage drops.	ERR LED	Flashing when a program error occurs. Lights when a CPU error occurs.
POW LED	On while power is on the PLC.								
RUN LED	On while the PLC is running.								
BAT LED	Lights when the battery voltage drops.								
ERR LED	Flashing when a program error occurs. Lights when a CPU error occurs.								
[6]	FX2NC/FX3UC Extension block connecting hooks								
[7]	Input LED								
[8]	Output LED								
[9]	Input connector (-T indicates terminal block type)								
[10]	Output connector (-T indicates terminal block type)								
[11]	Peripheral device connecting connector (RS-422)								
[12]	RUN/STOP switch								
[13]	FX2NC/FX3UC Extension block connecting connector cover								
[14]	Power connector for main unit								
[15]	Battery cover								

**1.2 External dimensions/weight**

**Main units (Connector type)**

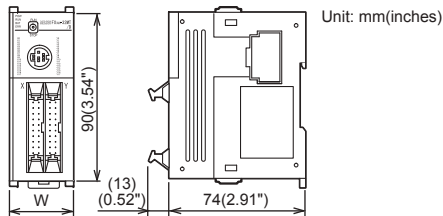

**Main units (Terminal block type)**

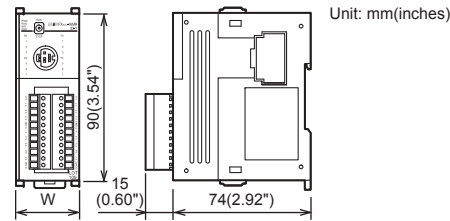

**FX2NC input/output extension blocks (Connector type)**

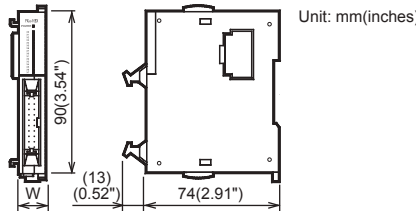

**FX2NC input/output extension blocks (Terminal block type)**

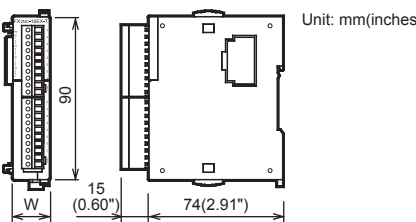

Type	Model name	W: mm (inches)	MASS (Weight): kg (lbs)
Main units (Connector type)	FX3UC-16MT/D(SS)	34.0 (1.34)	Approx. 0.2 (0.44)
	FX3UC-32MT/D(SS)	34.0 (1.34)	Approx. 0.2 (0.44)
	FX3UC-64MT/D(SS)	59.7 (2.36)	Approx. 0.3 (0.66)
	FX3UC-96MT/D(SS)	85.4 (3.37)	Approx. 0.35 (0.77)
Main units (Terminal block type)	FX3UC-16MR/D(S)-T	34.0 (1.34)	Approx. 0.25 (0.55)
Input/output extension blocks (Connector type)	FX2NC-16EX(-DS)	14.6 (0.57)	Approx. 0.15 (0.33)
	FX2NC-32EX(-DS)	26.2 (1.03)	Approx. 0.2 (0.44)
	FX2NC-16EYT(-DSS)	14.6 (0.57)	Approx. 0.15 (0.33)
	FX2NC-32EYT(-DSS)	26.2 (1.03)	Approx. 0.2 (0.44)
Input/output extension blocks (Terminal block type)	FX2NC-16EX-T(-DS)	20.2 (0.57)	Approx. 0.15 (0.33)
	FX2NC-16EYR-T(-DS)	24.2 (0.95)	Approx. 0.2 (0.44)

**2. General specifications and Installation**

→ For more details, refer to the FX3UC Series User's Manual - Hardware Edition

**INSTALLATION PRECAUTIONS** **WARNING**

- Make sure to cut off all phases of the power supply externally before attempting installation or wiring work. Failure to do so may cause electric shock or damage to the product.

**INSTALLATION PRECAUTIONS** **CAUTION**

- Use the product within the generic environment specifications described in section 2.1 of this manual. Never use the product in areas with excessive dust, oily smoke, conductive dusts, corrosive gas (salt air, Cl<sub>2</sub>, H<sub>2</sub>S, SO<sub>2</sub> or NO<sub>2</sub>), flammable gas, vibration or impacts, or expose it to high temperature, condensation, or rain and wind. If the product is used in such conditions, electric shock, fire, malfunctions, deterioration or damage may occur.
- Do not touch the conductive parts of the product directly. Doing so may cause device failures or malfunctions.
- Install the product securely using a DIN rail or mounting screws.
- Install the product on a flat surface. If the mounting surface is rough, undue force will be applied to the PC board, thereby causing nonconformities.
- When drilling screw holes or wiring, make sure that cutting and wiring debris do not enter the ventilation slits. Failure to do so may cause fire, equipment failures or malfunctions.

**INSTALLATION PRECAUTIONS** **CAUTION**

- Be sure to remove the dust proof sheet from the PLC's ventilation port when installation work is completed. Failure to do so may cause fire, equipment failures or malfunctions.
- Connect the extension cables, peripheral device cables, input/output cables and battery connecting cable securely to their designated connectors. Loose connections may cause malfunctions.
- Turn off the power to the PLC before attaching or detaching the following devices. Failure to do so may cause device failures or malfunctions.
  - Peripheral devices, extension units/blocks, connector conversion adapter, extension power supply units, special adapters, and FX Series terminal blocks
  - Battery and memory cassettes

**Notes**

- When a dust proof sheet is supplied with an extension unit/block, keep the sheet applied to the ventilation slits during installation and wiring work.
- To prevent temperature rise, do not install the PLC on a floor, a ceiling or a vertical surface. Install it horizontally on a wall as shown in section 2.2.
- Keep a space of 50 mm (1.97") or more between the unit main body and another device or structure (section 2.2 part A). Install the unit as far away as possible from high-voltage lines, high-voltage devices and power equipment.

**2.1 Generic specifications [Main unit]**

Item	Specification				
Ambient temperature	0 to 55 °C (32 to 131 °F) when operating and -25 to 75 °C (-13 to 167 °F) when stored				
Ambient humidity	5 to 95 %RH (no condensation) when operating				
Vibration resistance (*1)		Frequency (Hz)	Acceleration (m/s <sup>2</sup> )	Half amplitude (mm)	Sweep Count for X, Y, Z: 10 times (80 min. in each direction)
	When installed on DIN rail	10 to 57 57 to 150	- 4.9	0.035 -	
Shock resistance (*1)	(147 m/s <sup>2</sup> Acceleration, Action time: 11 ms, 3 times by half-sine pulse in each direction X, Y, and Z)				
Noise resistance	By noise simulator at noise voltage of 1,000 Vp-p, noise width of 1 μs, rise time of 1ns and period of 30 to 100 Hz				
Dielectric withstand voltage	500 V AC for one minute	Between batch of all terminals and ground terminal			
Insulation resistance	5 MΩ or higher by 500 V DC insulation resistance tester				
Grounding	Class D grounding (grounding resistance: 100 Ω or less) <Common grounding with a heavy electrical system is not allowed.> (*2)				
Working atmosphere	Free from corrosive or flammable gas and excessive conductive dusts				
Working altitude	<2000 m (*3)				

(\*1) The criterion is shown in IEC61131-2.

(\*2) For common grounding, refer to section 3.2.

(\*3) The PLC cannot be used at a pressure higher than the atmospheric pressure to avoid damage.

**2.2 Installation Location**

Install the PLC in an environment conforming to the generic specifications (section 2.1), installation precautions and notes.

→ For more details, refer to FX3UC Series User's Manual - Hardware Edition.

**Installation location in enclosure**

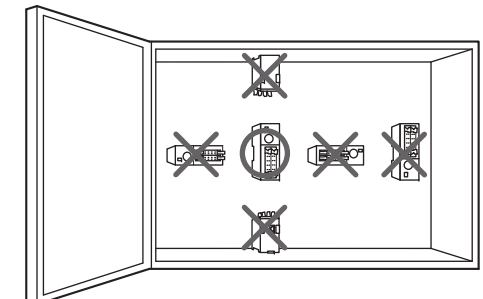



**Space in enclosure**

Extension devices can be connected on the left and right sides of the PLC main unit. If you intend to add extension devices in the future, keep extra space on the left and right sides open.

Configuration without extension cable

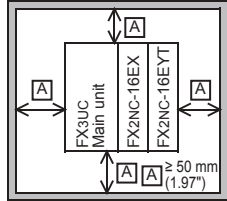

Configuration with extension cable

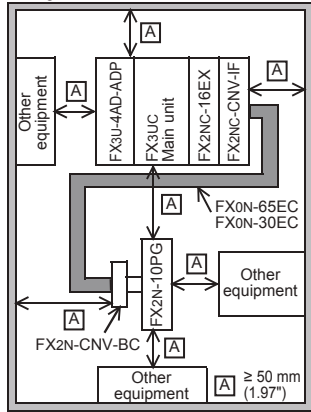

**2.3 Procedures for installing to and detaching from DIN rail**

The main unit can be installed on a DIN46277 rail [35 mm (1.38" wide)].

For detail, refer to the following manual.

→ Refer to **FX3UC Series User's Manual - Hardware Edition**.

**2.3.1 Installing methods**

- 1) Turn the power supply OFF.
- 2) Push the DIN rail mounting hooks ① of all connected units/blocks as shown in the figure on the right ①.

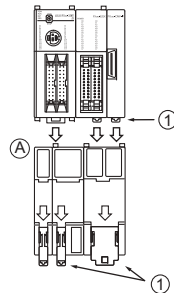

- 3) Align the upper side of the DIN rail mounting groove with the DIN rail (② in the figure on the right).

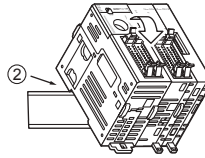

- 4) While pressing the main unit onto the DIN rail, lock the DIN rail mounting hooks as shown in the figure below ③.

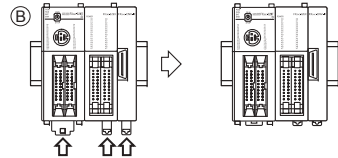

**2.3.2 Removal methods**

- 1) Turn the power supply OFF.
- 2) Disconnect all connected cables including the power cable and I/O cable.
- 3) Insert a flathead screwdriver to the DIN rail mounting hook (① in the figure on the right).
- 4) Lever the screwdriver slightly toward direction ②, to pull out the DIN rail mounting hooks, allowing them to come off the DIN rail.
- 5) Remove the main unit from the DIN rail (③ in the figure on the right).
- 6) Push the DIN rail mounting hooks as shown in the figure on the right ④.

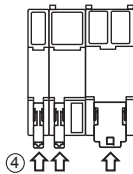
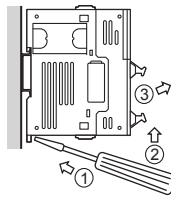

**2.4 Connection of power supply connector**

Use the dedicated built-in power connector to supply power to the main unit.

The power should be supplied to the main unit, FX2NC Series I/O extension blocks and FX2NC/FX3UC Series special extension blocks. Some (FX2NC-□□EX(-T)) of FX2NC Series I/O extension blocks require power cable types B and C shown on the right, while others (FX2NC-□□EX(-T)-DS) do not require them. For details, refer to FX3UC Series User's Manual - Hardware Edition.

When connecting two or more extension blocks which require power cables "B" and "C" shown on the right, perform crossover wiring between the extension blocks using two (upper and lower) power connectors.

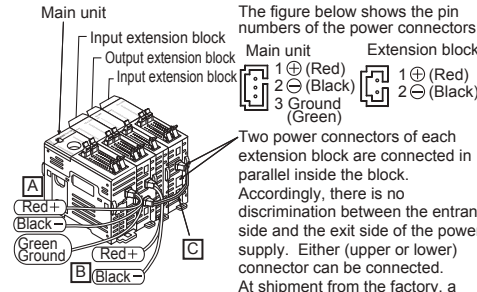

The figure below shows the pin numbers of the power connectors.

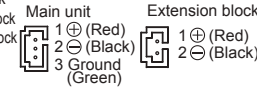

Two power connectors of each extension block are connected in parallel inside the block. Accordingly, there is no discrimination between the entrance side and the exit side of the power supply. Either (upper or lower) connector can be connected. At shipment from the factory, a resin cover is attached to the lower connector. Remove the resin cover from the lower connector when performing crossover wiring for the later block. (In case of the FX2NC-□□EX(-T)-DS, removal of the connector cover is unnecessary.)

**Removal of the power cable**

- 1) Turn the power supply OFF.
- 2) Pinch the power cable connector "a" and disconnect it in the direction of the arrow (see figure on the right).

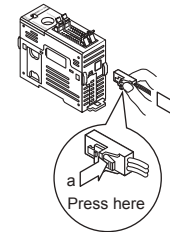

Power Cable types "A" and "B" are supplied with the main unit, while type "C" is supplied with the FX2NC-□□EX, FX2NC-16EX-T, and FX2NC/FX3UC series special function blocks.

Type	Application	Model	Length	Cable supplied with
A	Power cable for main unit	FX2NC-100MP/CB	1 m (3' 3")	FX3UC-□□IMT/D(SS), FX3UC-16MR/D(S)-T
B	Input power cable for FX2NC series input extension blocks and FX2NC/FX3UC series special function blocks	FX2NC-100BP/CB	1 m (3' 3")	FX3UC-□□IMT/D, FX3UC-16MR/D-T
C	Input power crossover cable for FX2NC series input extension blocks and FX2NC/FX3UC series special function blocks	FX2NC-10BPC/B1	0.1 m (3.93")	FX2NC-□□EX, FX2NC-16EX-T, and FX2NC/FX3UC series special function blocks

The crossover cable (type "C") can skip up to 4 16-point output blocks to connect units.

If more blocks should be skipped to supply power to an input block, use cable type "B".

**2.5 Connection to input/output connector**

The input/output connectors of the Main units (Connector type) conform to MIL-C-83503.

→ Refer to **Chapter 4 for the I/O connector pin arrangement**.

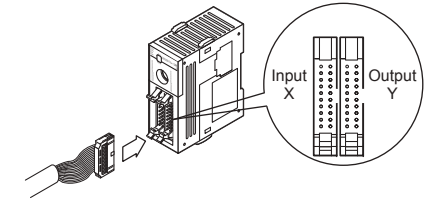

- 1) **Compliant connectors (commercially available connectors)**  
Use a 20-pin (1-key) socket connector conforming to MIL-C-83503. Confirm in advance that the connectors do not interfere with other parts including connector covers.

- 2) **Input/output cables (available from Mitsubishi)**

Input/output cables with attached connectors are available.

Model names	Length	Description	Shape
FX-16E-500CAB-S	5 m (16'4")	General-purpose input/output cable	<ul style="list-style-type: none"> <li>• Single wire (Wire color: red)</li> <li>• PLC side: A 20-pin connector</li> </ul>
FX-16E-150CAB	1.5 m (4'11")	Cables for connecting the FX Series terminal block with input/output connectors. For terminal block connection, refer to FX3UC Series User's Manual - Hardware Edition.	<ul style="list-style-type: none"> <li>• Flat cables (with tube)</li> <li>• A 20-pin connector at both ends</li> </ul>
FX-16E-300CAB	3 m (9'10")		
FX-16E-500CAB	5 m (16'4")		
FX-16E-150CAB-R	1.5 m (4'11")		
FX-16E-300CAB-R	3 m (9'10")	Cables for connecting the A Series Model A6TBXY36 connector/terminal block conversion unit and input/output connector type	<ul style="list-style-type: none"> <li>• Round multicore cables</li> <li>• A 20-pin connector at both ends</li> </ul>
FX-16E-500CAB-R	5 m (16'4")		
FX-A32E-150CAB	1.5 m (4'11")	Cables for connecting the A Series Model A6TBXY36 connector/terminal block conversion unit and input/output connector type	<ul style="list-style-type: none"> <li>• Flat cables (with tube)</li> <li>• PLC side: Two 20-pin connectors in 16-point units.</li> <li>• Terminal block side: A dedicated connector</li> <li>• One common terminal covers 32 input/output terminals.</li> </ul>
FX-A32E-300CAB	3 m (9'10")		
FX-A32E-500CAB	5 m (16'4")		

**3) Connectors for user-made input/output cables (available from Mitsubishi)**  
Users should provide electric wires and a pressure bonding tool.

Model name and composition of input/output connector		Applicable electric wire (UL-1061 are recommended) and tool		
Our model name	Details of part (made by DDK Ltd.)	Electric wire size	Pressure bonding tool (made by DDK Ltd.)	
FX2C-I/O-CON for flat cable	10-piece set Solderless connector FRC2-A020-30S	AWG28 (0.1 mm <sup>2</sup> ) 1.27 pitch, 20-core	357J-4674D: Main body 357J-4664N: Attachment	
FX2C-I/O-CON-S for bulk wire	5-piece set Housing HU-200S2-001 Solderless contact HU-411S	AWG22 (0.3 mm <sup>2</sup> )	357J-5538	
FX2C-I/O-CON-SA for bulk wire	5-piece set Housing HU-200S2-001 Solderless contact HU-411SA	AWG20 (0.5 mm <sup>2</sup> )	357J-13963	

**4) Certified connectors (commercially available connectors)**  
Connectors made by DDK Ltd. shown in item 3).

**2.6 Connection to input/output terminal block**

**2.6.1 Cable**

1) Applicable cable

Type	Wire size
Single wire	0.3 mm <sup>2</sup> to 0.5 mm <sup>2</sup> (AWG22 to 20)
Double wire	0.3 mm <sup>2</sup> (AWG22)×2

2) Termination

Strip the coating of strand wire and twist the cable core before connecting it, or strip the coating of single wire before connecting it. An alternative connection is to use a ferrule with insulating sleeve.

<Reference>

Manufacturer	Model	Caulking tool
Phoenix Contact	AI 0.5-8WH	CRIMPFOX 6 (*1) (or CRIMPFOX 6T-F (*2))

(\*1) Old model name: CRIMPFOX ZA 3

(\*2) Old model name: CRIMPFOX UD 6

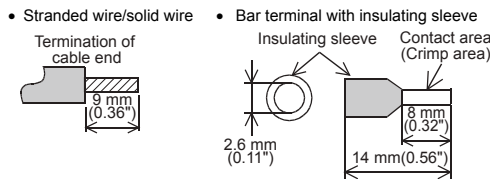

When using a stick terminal with an insulating sleeve, choose a wire with proper cable sheath referring to the above outside dimensions, otherwise the wire cannot be inserted easily.

**2.6.2 Tightening Torque**

Tighten the terminals to a torque of 0.22 to 0.25 N·m. Do not tighten terminal screws with a torque outside the above-mentioned range. Failure to do so may cause equipment failures or malfunctions.

**Tool**

To tighten terminals, use a purchased small-sized screwdriver whose head is straight and is not widened as shown in the right figure.

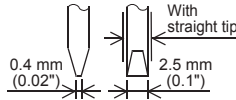

**Note:**

If the diameter of screwdriver grip is too small, tightening torque will not be able to be achieved. To achieve the appropriate tightening torque shown in the table above, use the following screwdriver or an appropriate replacement (grip diameter approximately 25 mm (0.98")).

<Reference>

Manufacturer	Model
Phoenix Contact	SZS 0.4×2.5

**3. Power supply/input/output specifications and examples of external wiring**

**DESIGN PRECAUTIONS** **WARNING**

- Make sure to have the following safety circuits outside of the PLC to ensure safe system operation even during external power supply problems or PLC failure. Otherwise, malfunctions may cause serious accidents.
  - Most importantly, have the following: an emergency stop circuit, a protection circuit, an interlock circuit for opposite movements (such as normal vs. reverse rotation), and an interlock circuit (to prevent damage to the equipment at the upper and lower positioning limits).
  - Note that when the PLC CPU detects an error, such as a watchdog timer error, during self-diagnosis, all outputs are turned off. Also, when an error that cannot be detected by the PLC CPU occurs in an input/output control block, output control may be disabled. External circuits and mechanisms should be designed to ensure safe machinery operation in such a case.
  - Note that when an error occurs in a relay, triac or transistor output device, the output could be held either on or off. For output signals that may lead to serious accidents, external circuits and mechanisms should be designed to ensure safe machinery operation in such a case.

**DESIGN PRECAUTIONS** **CAUTION**

- Do not bundle the control line together with or lay it close to the main circuit or power line. As a guideline, lay the control line at least 100 mm (3.94") or more away from the main circuit or power line. Noise may cause malfunctions.
- Install module so that excessive force will not be applied to peripheral device connectors, power connectors or input/output connectors. Failure to do so may result in wire damage/breakage or PLC failure.

Notes
<ul style="list-style-type: none"> <li>Simultaneously turn on and off the power supplies of the main unit and extension devices.</li> <li>Even if the power supply causes an instantaneous power failure for 5 ms or less, the PLC can continue to operate.</li> <li>If a long-time power failure or an abnormal voltage drop occurs, the PLC stops, and output is turned off. When the power supply is restored, it will automatically restart (when the RUN input is on).</li> </ul>

**WIRING PRECAUTIONS** **WARNING**

- Make sure to cut off all phases of the power supply externally before attempting installation or wiring work. Failure to do so may cause electric shock or damage to the product.

**WIRING PRECAUTIONS** **CAUTION**

- Connect the DC power supply wiring to the dedicated terminals described in this manual. If an AC power supply is connected to a DC input/output terminal or DC power supply terminal, the PLC will burn out.
- Do not wire vacant terminals externally. Doing so may damage the product.
- Perform class D grounding (grounding resistance: 100 Ω or less) to the grounding terminal on the main unit. Do not use common grounding with heavy electrical systems (refer to section 3.2).
- When drilling screw holes or wiring, make sure cutting or wire debris does not enter the ventilation slits. Failure to do so may cause fire, equipment failures or malfunctions.
- Make sure to properly wire to the terminal block (European type) in accordance with the following precautions. Failure to do so may cause electric shock, equipment failures, a short-circuit, wire breakage, malfunctions, or damage to the product.
  - The disposal size of the cable end should follow the dimensions described in the manual.
  - Tightening torque should follow the specifications in the manual.
  - Twist the end of strand wire and make sure that there are no loose wires.
  - Do not solder-plate the electric wire ends.
  - Do not connect more than the specified number of wires or electric wires of unspecified size.
  - Affix the electric wires so that neither the terminal block nor the connected parts are directly stressed.

**Notes**

- Input/output wiring 50 to 100 m (164'1" to 328'1") long will cause almost no problems of noise, but, generally, the wiring length should be less than 20 m (65'7") to ensure the safety.
- Extension cables are easily affected by noise. Lay the cables at a distance of at least 30 to 50 mm (1.19" to 1.97") away from the PLC output and other power lines.

**3.1 Power supply specifications and example of external wiring**

→ For more details, refer to FX3UC Series User's Manual - Hardware Edition.

**3.1.1 Power supply specifications**

The specifications for the power supply of the main unit are shown in the following table.

Item	Specification	
Supply voltage	24 V DC +20 % -15 % (*1)	Ripple Voltage (p-p) 5 % or less
Allowable instantaneous power failure time	Operation can be continued upon occurrence of an instantaneous power failure for 5 ms or less.	
Power fuse	125 V 3.15 A	
Rush current	30 A max.0.5 ms/24 V DC	
Power consumption (*1)	FX3UC-16MT/D(SS) FX3uc-16MR/D(S)-T	6 W
	FX3UC-32MT/D(SS)	8 W
	FX3UC-64MT/D(SS) FX3UC-96MT/D(SS)	11 W 14 W
5 V DC built-in power supply(*2)	FX3UC-16MT/D(SS) FX3UC-16MR/D(S)-T	600 mA
	FX3UC-32MT/D(SS)	560 mA
	FX3UC-64MT/D(SS) FX3UC-96MT/D(SS)	480 mA 400 mA

(\*1) Input/output extension blocks and special function units/blocks are not contained in power consumption. For power consumption of the FX2NC input/output extension blocks, refer to the following table.

→ Refer to the FX3UC Series User's Manual - Hardware Edition.  
→ For the power consumed by the special function units/blocks, refer to the appropriate manuals.

Model names	Power consumption
FX2NC-16EX-T-(DS)	2.2 W
FX2NC-16EX-(DS)	2.2 W
FX2NC-32EX-(DS)	4.2 W
FX2NC-16EYR-T-(DS)	2.2 W
FX2NC-16EYT-(DSS)	0.35 W
FX2NC-32EYT-(DSS)	0.7 W

(\*2) Cannot be used to supply power to an external destination. This power is supplied to input/output extension blocks, special extension blocks and special adapters only.

**3.1.2 Example of external wiring (power type)**

Supply 24 V DC power to the main unit and FX2NC-□□EX(-T) using the dedicated connector.

→ For the details of wiring work, refer to Section 2.4.  
→ For the power supply wiring of the FX2NC input extension blocks, refer to the Subsection 3.3.3.

Use a 24 V DC +20 % -15 % DC power supply whose ripple (p-p) is within 5 %. The allowable range of the 24 V DC power supply may be narrower when special function units/blocks are connected.

→ For more details, refer to the FX3UC Series User's Manual - Hardware Edition.

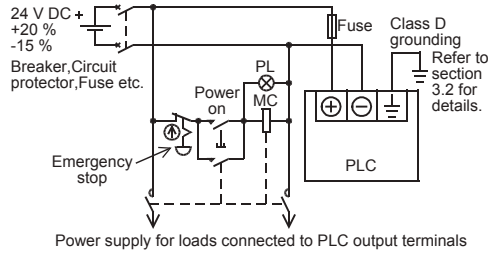

### 3.2 Grounding

Ground the PLC as stated below.

- Perform class D grounding. (Grounding resistance: 100 Ω or less)
- Ground the PLC independently if possible. If it cannot be grounded independently, ground it jointly as shown below.

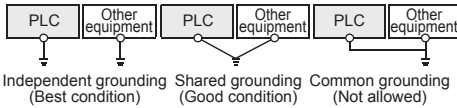

- Position the grounding point as close to the PLC as possible to decrease the length of the ground wire.

### 3.3 Input specifications and external wiring

→ For more details, refer to the FX3UC Series User's Manual - Hardware Edition.

#### 3.3.1 Input specifications

Item	Input specification (24 V DC)	
Number of input points	FX3UC-16MT/D(SS) FX3UC-16MR/D(S)-T	8 points
	FX3UC-32MT/D(SS)	16 points
	FX3UC-64MT/D(SS)	32 points
	FX3UC-96MT/D(SS)	48 points
	FX2NC-16EX(-DS)	16 points
	FX2NC-32EX(-DS)	32 points
Input connecting type	FX3UC-□□MT/D(SS) FX2NC-□□EX(-DS)	connector
	FX3UC-16MR/D(S)-T FX2NC-16EX-T(-DS)	Terminal block
Input form	FX3UC-□□MT/D FX3UC-16MR/D-T FX2NC-□□EX FX2NC-16EX-T	Sink
	FX3UC-□□MT/DSS FX3UC-16MR/D(S)-T FX2NC-□□EX-DS FX2NC-16EX-T-DS	Sink/Source
Input signal voltage	24 V DC +20% -15% Ripple Voltage (p-p) 5% or less	
Input impedance	X000 to X005	3.9 kΩ
	X006, X007	3.3 kΩ
	X010 or more (*1) Input extension blocks	4.3 kΩ

Item	Input specification (24 V DC)	
Input signal current	X000 to X005	6 mA/24 V DC
	X006, X007	7 mA/24 V DC
	X010 or more (*1) Input extension blocks	5 mA/24 V DC
ON input sensitivity current	X000 to X005	3.5 mA or more
	X006, X007	4.5 mA or more
	X010 or more (*1) Input extension blocks	3.5 mA or more
Input OFF current	1.5 mA or less	
Input response time	Approx. 10 ms (*2)	
Input signal form	FX3UC-□□MT/D FX3UC-16MR/D-T FX2NC-□□EX FX2NC-16EX-T	No-voltage contact input NPN open collector transistor
	FX3UC-□□MT/DSS FX3UC-16MR/D(S)-T FX2NC-□□EX-DS FX2NC-16EX-T-DS	• Sink input: No-voltage contact input NPN open collector transistor • Source input: No-voltage contact input PNP open collector transistor
Input circuit insulation	Photocoupler insulation	
Input operation display	LED on panel turns ON when photocoupler is driven.	

(\*1) Does not apply to FX3UC-16M□.

(\*2) 000 to X017 use adjustable digital filter values.

When setting the input filter for X000 to X005 to 5 μs or capturing pulses of a 50 to 100 kHz response frequency with a high speed counter, wire the terminals as stated below.

- The wiring length should be 5 m (16'4") or less.
- Connect a bleeder resistor of 1.5 kΩ (1 W or more) to the input terminal, so that the sum of the load current of the open collector transistor output on the connected device and the input current of the main body is 20 mA or more.

#### 3.3.2 Handling of input terminal

- 1) FX3UC-□□MT/D, FX3UC-16MR/D-T, FX2NC-□□EX(-T)**  
Inputs turn ON when the input terminal and COM terminal are electrically connected with a no-voltage contact or NPN open collector transistor
- 2) FX3UC-□□MT/DSS, FX3UC-16MR/DS-T, FX2NC-□□EX(-T)-DS**
  - sink input  
Inputs turn ON when the 24 V DC ⊕ terminal and COM△ terminal or COM terminal are connected, and the input terminal and 24 V DC ⊖ terminal are electrically connected with a no-voltage contact or NPN open collector transistor.
  - source input  
Inputs turn ON when the 24 V DC ⊖ terminal and COM△ terminal or COM terminal are connected, and the input terminal and 24 V DC ⊕ terminal are electrically connected with a no-voltage contact or PNP open collector transistor.  
Where △ indicates: 0 to 2

### 3.3.3 Example of input wiring

#### 1. Examples of input wiring (FX3UC-□□MT/D, FX3UC-16MR/D-T)

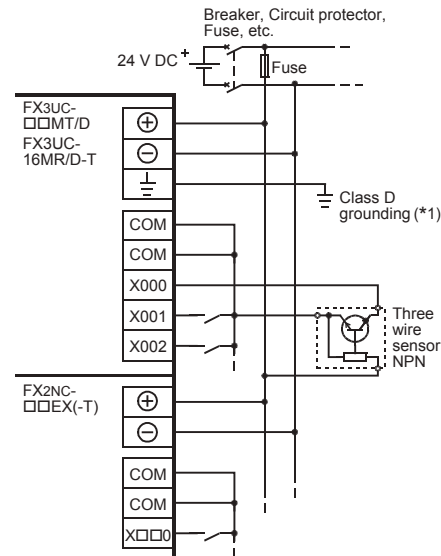

(\*1) The grounding resistance should be 100 Ω or less.

#### 2. Examples of sink input wiring (FX3UC-□□MT/DSS, FX3UC-16MR/DS-T)

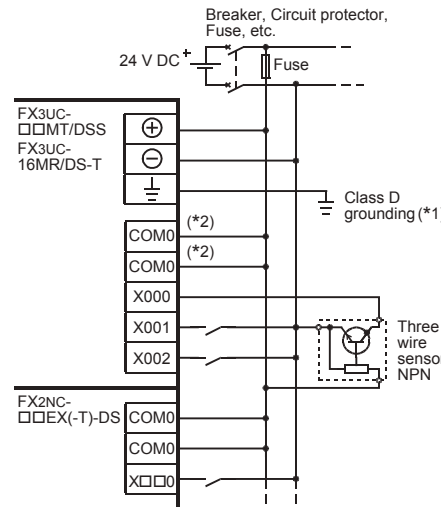

(\*1) The grounding resistance should be 100 Ω or less.

(\*2) In FX3UC-64MT/DSS or FX3UC-96MT/DSS units, the COM0, COM1 and COM2 terminals are not connected internally. Wire the COM0, COM1 and COM2 terminals respectively.

### 3. Examples of source input wiring (FX3UC-□□MT/DSS, FX3UC-16MR/DS-T)

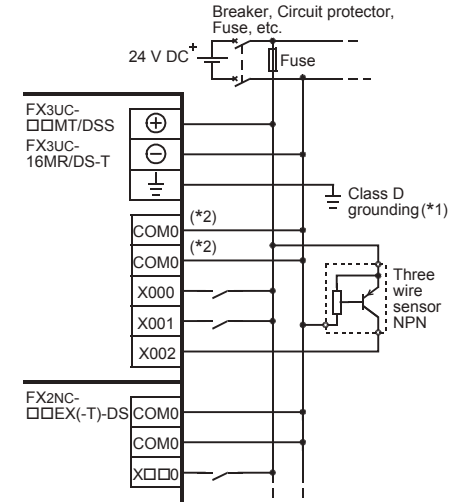

(\*1) The grounding resistance should be 100 Ω or less.

(\*2) In FX3UC-64MT/DSS or FX3UC-96MT/DSS units, the COM0, COM1 and COM2 terminals are not connected internally. Wire the COM0, COM1 and COM2 terminals respectively.

### 3.4 Output specifications and example of external wiring

→ For more details, refer to the FX3UC Series User's Manual - Hardware Edition.

#### 3.4.1 Transistor output specifications

Item	Output specification (Transistor)	
Number of output points	FX3UC-16MT/D(SS)	8 points
	FX3UC-32MT/D(SS)	16 points
	FX3UC-64MT/D(SS)	32 points
	FX3UC-96MT/D(SS)	48 points
	FX2NC-16EYT(-DSS)	16 points
	FX2NC-32EYT(-DSS)	32 points
Output connecting type	connector	
Output form	FX3UC-□□MT/D FX2NC-□□EYT	Sink
	FX3UC-□□MT/DSS FX2NC-□□EYT-DSS	Source
External power supply	5 to 30V DC	

Item			Output specification (Transistor)	
Max. load	Resistance load	Main units	Y000 to Y003	0.3 A/point
			Y004 or more	0.1 A/point
		FX2NC-□□EYT (-DSS)		0.1 A/point
	Inductive load	Main units	Y000 to Y003	7.2 W/point (24 V DC)
Y004 or more			2.4 W/point (24 V DC)	
		FX2NC-□□EYT (-DSS)	2.4 W/point (24 V DC)	
Open circuit leakage current			0.1 mA or less/30 V DC	
Response time	OFF→ON	Main units	Y000 to Y002	5 μs or less/10 mA or more (5 to 24 V DC) (*2)
			Y003 or more	0.2 ms or less/100 mA or more (at 24 V DC) (*3)
		FX2NC-□□EYT (-DSS)		0.2 ms or less/100 mA or more (at 24 V DC)
	ON→OFF	Main units	Y000 to Y002	5 μs or less/10 mA or more (5 to 24 V DC) (*2)
Y003 or more			0.2 ms or less/100 mA or more (at 24 V DC) (*3)	
		FX2NC-□□EYT (-DSS)		0.2 ms or less/100 mA or more (at 24 V DC)
Output circuit insulation			Photocoupler insulation	
Output operation display			LED on panel turns ON when photocoupler is driven.	

(\*1) When the two COM□ terminal are connected outside the PLC, resistance load is 1.6 A or less.

(\*2) When using an instruction related to pulse train output or positioning, make sure to set the load current to 10 to 100 mA (5 to 24 V DC).

(\*3) The transistor OFF time is longer under lighter loads. For example, under a load of 24 V DC 40 mA, the response time is approx. 0.3 ms. When response performance is required under light loads, provide a dummy resistor to increase the load current.

### 3.4.2 Handling of transistor output circuit

#### Output terminal:

The main unit and FX2NC input/output extension block have 16 transistor output points per common. Two COM★ or +V△ terminals connected to each other inside the PLC are provided for outputs. Connect two COM★ or +V△ terminals outside the PLC so that the load applied to each COM★ or +V△ terminal is smaller. Where ★ indicates: 1 to 3 Where △ indicates: 0 to 2

#### Output current

The ON voltage of the output transistor is approx. 1.5 V. When driving a semiconductor element, carefully check the input voltage characteristics of the applied element.

### 3.4.3 Example of transistor output wiring

#### 1. Examples of sink output wiring

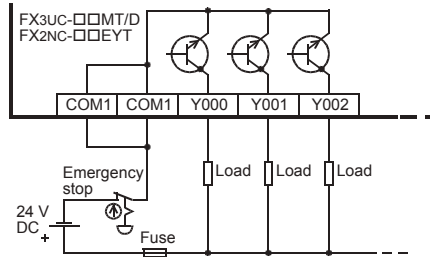

#### 2. Examples of source output wiring

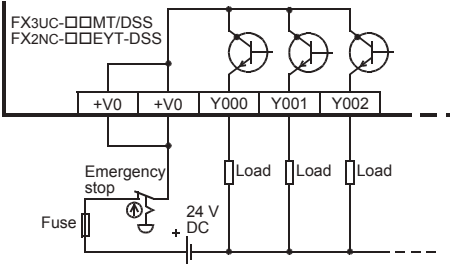

### 3.4.4 Relay output specifications

→ For more details, refer to the FX3UC Series User's Manual - Hardware Edition.

Item		Output specification (Relay)	
Number of output points		FX3UC-16MR/D(S)-T	8 points
		FX2NC-16EYR-T(-DS)	16 points
Output connecting type		Terminal block	
External power supply		30 V DC or less or 240 V AC or less (250 V AC or less when the unit does not comply with CE, UL or cUL standards)	
Max. load	Resistance load	2 A /point	When using one COM□ terminal, make sure that the total load current of 4 or 8 resistance load points is 4 A or less. When connecting two COM□ terminals outside the PLC, make sure that the total load current of 8 resistance load points is 8 A or less.
	Inductive load	80 VA	→ For the product life of relay contacts, refer to the FX3uc Series User's Manual - Hardware Edition.
Min. load		5 V DC, 2 mA (reference value)	
Open circuit leakage current		-	
Response time	OFF→ON	Approx. 10 ms	
	ON→OFF	Approx. 10 ms	

Item	Output specification (Relay)
Output circuit insulation	Mechanical insulation
Output operation display	LED on panel lights when power is applied to relay coil.

### 3.4.5 Handling of relay output circuit

#### Output terminal:

Main units, FX2NC input/output extension blocks have 4 or 8 relay output points per common. Two COM★ terminals connected to each other inside the FX2NC-16EYR-T(-DS) are provided for outputs. Connect two COM★ terminals outside the PLC so that the load applied to each COM★ terminal is smaller. Where ★ indicates: 1 or 2

### 3.4.6 Example of relay output wiring

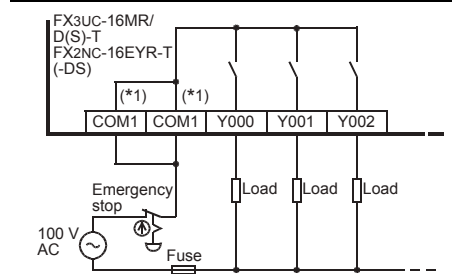

(\*1) As for the number of COM1 terminals, FX3UC-16MR/D(S)-T is one.

### 3.5 Cautions in input and output wiring

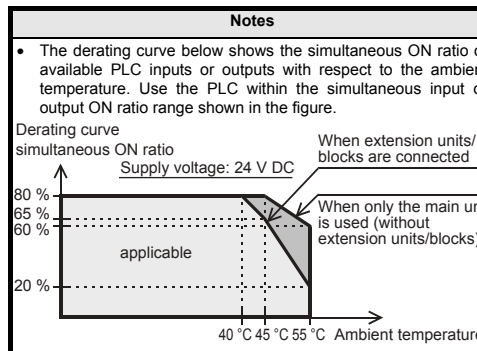

#### 3.5.1 Instructions for input devices

The input current of this PLC is 5 to 7 mA/24 V DC. Use input devices applicable to this minute current. If switches for larger current are being used, contact failure may occur.

→ For more details, refer to FX3uc Series User's Manual - Hardware Edition.

- In the case of input devices with built-in series diodes: The voltage drop of the series diode should be approx. 4 V or less. When lead switches with a series LED are used, up to two switches can be connected in series. Also make sure that the input current is over the input-sensing level while the switches are ON. (ex.) Lead switches with a series LED
- In the case of input device with built-in parallel resistance: Use a device with a parallel resistance of 15 kΩ or more. When the resistance is less than 15 kΩ, connect a bleeder resistor.
- In the case of 2-wire proximity switch: Use a two-wire proximity switch whose leakage current is 1.5 mA or less when the switch is off. When the current is larger than 1.5 mA, connect a bleeder resistor.

### 3.5.2 Cautions on transistor output wiring

→ For more details, refer to FX3UC Series User's Manual - Hardware Edition.

- Protection circuit for load short-circuits: A short-circuit at a load connected to an output terminal could cause burnout at the output element or the PC board. To prevent this, a protection fuse should be included at the output. Use a load power supply capacity that is two times or more the total rated capacity of the fuses connected to the load circuit.
- Contact protection circuit for inductive loads: When an inductive load is connected, connect a diode (for commutation) in parallel with the load as necessary. The diode (for commutation) must comply with the following specifications.

Reverse voltage	5 to 10 times of the load voltage
Forward current	Load current or more

- Interlock: Loads, such as contactors for normal and reverse rotations, that must not be turned on simultaneously should have an interlock in the PLC program and an external interlock.

### 3.5.3 Cautions on relay output wiring

→ For more details, refer to FX3UC Series User's Manual - Hardware Edition.

- Protection circuit for load short-circuits: A short-circuit at a load connected to an output terminal could cause burnout at the output element or the PC board. To prevent this, a protection fuse should be included at the output.
  - Protection circuit of contact when inductive load is used: An internal protection circuit for the relays is not provided for the relay output circuit. It is recommended to use inductive loads with built-in protection circuits. When using loads without built-in protection circuits, insert an external contact protection circuit, etc. to reduce noise and extend the product life.
- a) DC circuit  
Connect a diode in parallel with the load. Use a diode (for commutation) having the following specifications.

Reverse voltage	5 to 10 times of the load voltage
Forward current	Load current or more

- b) AC circuit  
Connect the surge absorber (combined CR components such as a surge killer and spark killer, etc.) parallel to the load. Select the rated voltage of the surge absorber suitable to the output used. Refer to the table below for other specification

Electrostatic capacity	Approx. 0.1 μF
Resistance value	Approx. 100 to 200 Ω



- 3) Interlock  
Loads, such as contactors for normal and reverse rotations, that must not be turned on simultaneously should have an interlock in the PLC program and an external interlock.

- 4) Common mode  
Use output contacts of the PLC in the common mode.

## 4. Terminal Layout

### 4.1 Main units

#### 4.1.1 FX3uc-□□MT/D

The I/O wiring is different in the FX3uc-□□MT/DSS. Refer to Sections 3.3 and 3.4 for the details.

##### FX3uc-16MT/D

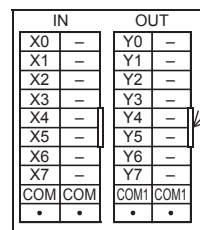

##### FX3uc-32MT/D

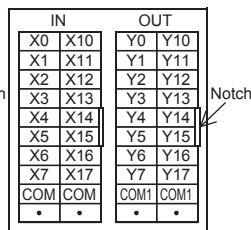

##### FX3uc-64MT/D

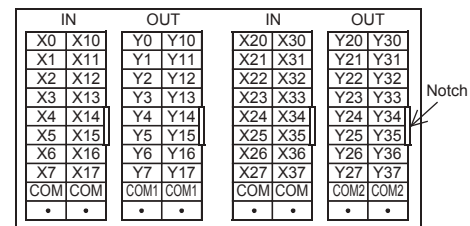

##### FX3uc-96MT/D

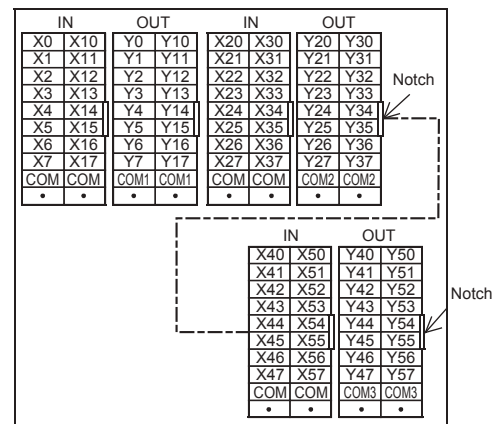

#### 4.1.2 FX3uc-□□MT/DSS

The I/O wiring is different in the FX3uc-□□MT/D. Refer to Sections 3.3 and 3.4 for the details.

##### FX3uc-16MT/DSS

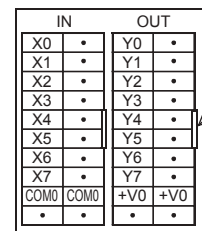

##### FX3uc-32MT/DSS

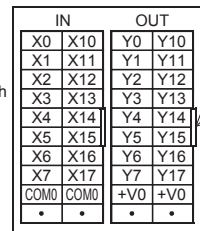

##### FX3uc-64MT/DSS

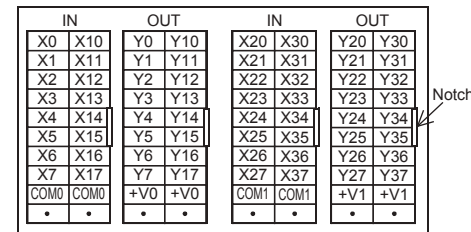

##### FX3uc-96MT/DSS

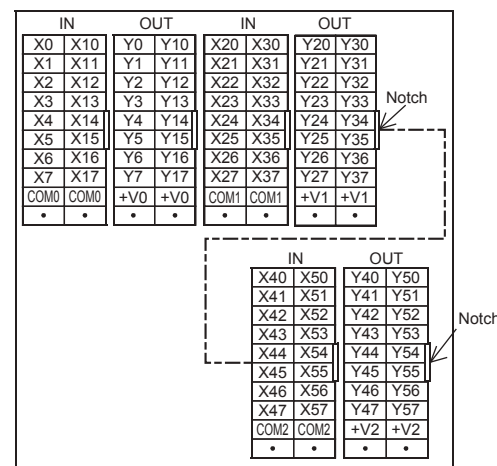

#### 4.1.3 FX3uc-16MR/D(S)-T

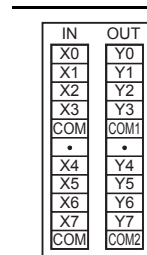

#### 4.2 FX2NC input/output extension blocks

##### 4.2.1 FX2NC-□□EX(-DS)

###### FX2NC-16EX

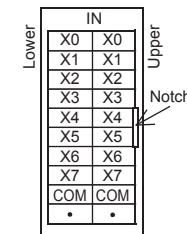

###### FX2NC-32EX

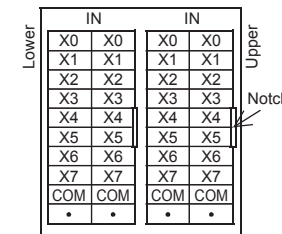

###### FX2NC-16EX-DS

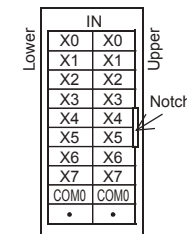

###### FX2NC-32EX-DS

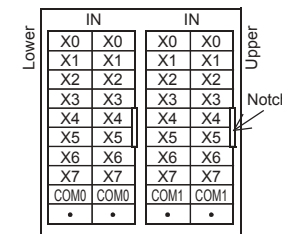

##### 4.2.2 FX2NC-□□EYT(-DSS)

###### FX2NC-16EYT

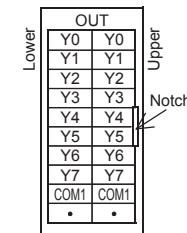

###### FX2NC-32EYT

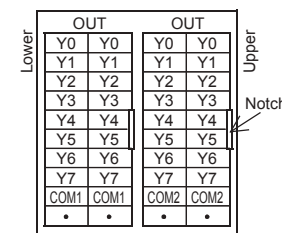

###### FX2NC-16EYT-DSS

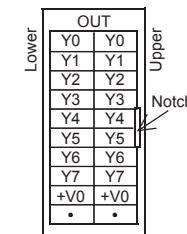

###### FX2NC-32EYT-DSS

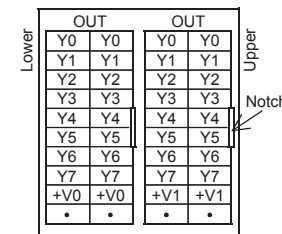

#### 4.2.3 FX2NC-16EX-T(-DS), FX2NC-16EYR-T(-DS)

##### FX2NC-16EX-T(-DS)

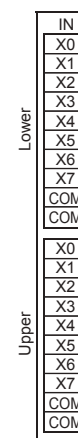

##### FX2NC-16EYR-T(-DS)

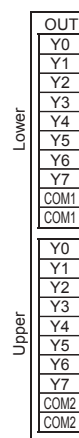

This manual confers no industrial property rights or any rights of any other kind, nor does it confer any patent licenses. Mitsubishi Electric Corporation cannot be held responsible for any problems involving industrial property rights which may occur as a result of using the contents noted in this manual.

#### Warranty

Exclusion of loss in opportunity and secondary loss from warranty liability  
Regardless of the gratis warranty term, Mitsubishi shall not be liable for compensation to be:

- Damages caused by any cause found not to be the responsibility of Mitsubishi.
- Loss in opportunity, lost profits incurred to the user by Failures of Mitsubishi products.
- Special damages and secondary damages whether foreseeable or not, compensation for accidents, and compensation for damages to products other than Mitsubishi products.
- Replacement by the user, maintenance of on-site equipment, start-up test run and other tasks.

#### ⚠ For safe use

- This product has been manufactured as a general-purpose part for general industries, and has not been designed or manufactured to be incorporated in a device or system used in purposes related to human life.
- Before using the product for special purposes such as nuclear power, electric power, aerospace, medicine or passenger movement vehicles, consult with Mitsubishi Electric.
- This product has been manufactured under strict quality control. However when installing the product where major accidents or losses could occur if the product fails, install appropriate backup or failsafe functions in the system.

### MITSUBISHI ELECTRIC CORPORATION

HEAD OFFICE : TOKYO BUILDING, 2-7-3 MARUNOUCHI, CHIYODA-KU, TOKYO 100-8310, JAPAN