



PROGRAMMABLE CONTROLLERS  
MELSEC-F

Side A JAPANESE  
Side B ENGLISH

FX3U-4AD

INSTALLATION MANUAL



Manual Number	JY997D20701
Revision	E
Date	March 2016

This manual describes the part names, dimensions, mounting, and specifications of the product. Before use, read this manual and the manuals of all relevant products fully to acquire proficiency in handling and operating the product. Make sure to learn all the product information, safety information, and precautions. Store this manual in a safe place so that it can be taken out and read whenever necessary. Always forward it to the end user.

Registration:  
Phillips is a registered trademark of Phillips Screw Company. The company and product names described in this manual are registered trademarks or the trademarks of their respective companies.

Effective March 2016  
Specifications are subject to change without notice.  
© 2006 MITSUBISHI ELECTRIC CORPORATION

**Safety Precaution** (Read these precautions before use.)

This manual classifies the safety precautions into two categories:

**WARNING** and **CAUTION**.

<b>WARNING</b>	Indicates that incorrect handling may cause hazardous conditions, resulting in death or severe injury.
<b>CAUTION</b>	Indicates that incorrect handling may cause hazardous conditions, resulting in medium or slight personal injury or physical damage.

Depending on the circumstances, procedures indicated by **CAUTION** may also cause severe injury. It is important to follow all precautions for personal safety.

**Associated Manuals**

Manual name	Manual No.	Description
FX3S/FX3G/FX3GC/FX3U/FX3UC Series User's Manual - Analog Control Edition	JY997D16701 MODEL CODE: 09R619	Describes specifications for analog control and programming method for FX3S/FX3G/FX3GC/FX3U/FX3UC Series PLC.
FX3S/FX3G/FX3GC/FX3U/FX3UC Series Programming Manual - Basic & Applied Instruction Edition	JY997D16601 MODEL CODE: 09R517	Describes PLC programming for basic/applied instructions and devices.
FX3G Series User's Manual - Hardware Edition	JY997D31301 MODEL CODE: 09R521	Explains the FX3G Series PLC specifications for I/O, wiring, installation, and maintenance.
FX3U Series User's Manual - Hardware Edition	JY997D16501 MODEL CODE: 09R516	Explains the FX3U Series PLC specifications for I/O, wiring, installation, and maintenance.
FX3UC Series User's Manual - Hardware Edition	JY997D28701 MODEL CODE: 09R519	Explains the FX3UC Series PLC specifications for I/O, wiring, installation, and maintenance.

**How to obtain manuals**

For product manuals or documents, consult with the Mitsubishi Electric dealer from who you purchased your product.

**Certification of UL, cUL standards**

The following product has UL and cUL certification.  
**UL, cUL File Number: E95239**  
**Models: MELSEC FX3U series manufactured FX3U-4AD**

**Compliance with EC directive (CE Marking)**

This note does not guarantee that an entire mechanical module produced in accordance with the contents of this note will comply with the following standards. Compliance to EMC directive and LVD directive for the entire mechanical module should be checked by the user / manufacturer. For more details please contact the local Mitsubishi Electric sales site.

**Requirement for Compliance with EMC directive**

The following products have shown compliance through direct testing (of the identified standards below) and design analysis (through the creation of a technical construction file) to the European Directive for Electromagnetic Compatibility (2004/108/EC) when used as directed by the appropriate documentation.

**Attention**

This product is designed for use in industrial applications.

**Type: Programmable Controller (Open Type Equipment)**

**Models: MELSEC FX3U series manufactured from February 1st, 2006 FX3U-4AD**

Standard	Remark
EN61131-2:2007 Programmable controllers - Equipment requirements and tests	Compliance with all relevant aspects of the standard. <b>EMI</b> • Radiated Emission • Conducted Emission <b>EMS</b> • Radiated electromagnetic field • Fast transient burst • Electrostatic discharge • High-energy surge • Voltage drops and interruptions • Conducted RF • Power frequency magnetic field

**Caution for EC Directive**

The FX3U-4AD have been found to be compliant to the European standards in the aforesaid manual and directive. However, for the very best performance from what are in fact delicate measuring and controlled output device Mitsubishi Electric would like to make the following points:  
As analog devices are sensitive by nature, their use should be considered carefully. For users of proprietary cables (integral with sensors or actuators), these users should follow those manufacturers installation requirements. Mitsubishi Electric recommend that shielded cables should be used. If NO other EMC protection is provided, then users may experience temporary loss or accuracy between ±10% in very heavy industrial areas.  
However, Mitsubishi Electric suggest that if adequate EMC precautions are followed for the users complete control system, users should expect accuracy as specified in this manual.

- Sensitive analog cable should not be laid in the same trunking or cable conduit as high voltage cabling. Where possible users should run analog cables separately.
- Good cable shielding should be used. Ground the shield of the twisted shielded cable at one point on the PLC side.
- When reading analog values, EMC accuracy can be improved out by averaging the readings. This can be achieved either through functions on the special function block for analog input or through a users program in the FX3U Series PLC main unit.
- Please use FX3U-4AD while installed in a shielded enclosure. For the details, refer to the following manual.  
→ Refer to the FX3U Series User's Manual - Hardware Edition  
→ Refer to the FX3UC Series User's Manual - Hardware Edition

**Note for compliance with EN61131-2:2007**

General note on the use of the power supply cable.  
The FX3U-4AD unit requires that the cable used for power supply is 30m or less.

**1. Outline**

The FX3U-4AD special function block for analog input converts four analog input values (voltage, current) to digital values and transfers those digital values to the PLC main unit.

**1.1 Incorporated Items**

Verify that if the following product and items are included in the package:

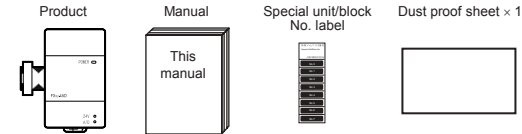

**1.2 External Dimensions, Part Names, and Terminal Layout**

**1.2.1 External Dimensions and Part Names**

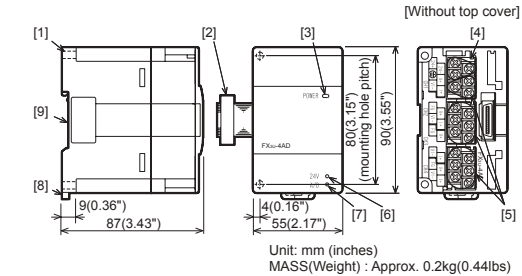

- [1] Direct mounting hole: 2 holes of φ4.5 (0.18") (mounting screw: M4 screw)
- [2] Extension cable
- [3] POWER LED (green): Lit while 5V DC power is supplied from PLC.
- [4] Terminal block for power supply (24V DC) (M3 terminal screw)
- [5] Terminal block for analog input
- [6] 24V LED (red): Lit while 24V DC power is supplied properly to terminals [24+] and [24-].
- [7] A/D LED (red): Flashes (at high speed) during A/D conversion.
- [8] DIN rail mounting hook
- [9] DIN rail mounting groove (35 mm (1.38") wide)

**1.2.2 Terminal Layout**

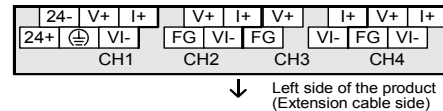

**2. Installation**

**INSTALLATION PRECAUTIONS**

- Use the product within the generic environment specifications described in PLC main unit manual (Hardware Edition). Never use the product in areas with excessive dust, oily smoke, conductive dusts, corrosive gas (salt air, Cl<sub>2</sub>, H<sub>2</sub>S, SO<sub>2</sub>, or NO<sub>2</sub>), flammable gas, vibration or impacts, or expose it to high temperature, condensation, or rain and wind. If the product is used in such conditions, electric shock, fire, malfunctions, deterioration or damage may occur.
- Do not touch the conductive parts of the product directly. Doing so may cause device failures or malfunctions.
- Install the product securely using a DIN rail or mounting screws.
- Install the product on a flat surface. If the mounting surface is rough, undue force will be applied to the PC board, thereby causing nonconformities.
- When drilling screw holes or wiring, make sure cutting or wire debris does not enter the ventilation slits. Failure to do so may cause fire, equipment failures or malfunctions.

**INSTALLATION PRECAUTIONS**

- Be sure to remove the dust proof sheet from the PLC's ventilation port when installation work is completed. Failure to do so may cause fire, equipment failures or malfunctions.
- Connect extension cables securely to their designated connectors. Loose connections may cause malfunctions.

**2.1 Arrangements**

The product connects on the right side of an PLC main unit or extension units/blocks (including special function units/blocks). For connection to FX3UC Series PLC or FX2NC Series PLC extension block, FX2NC-CNV-IF or FX3UC-1PS-5V is required. For further information of installation arrangements, refer to the following manual.  
→ Refer to the FX3U Series User's Manual - Hardware Edition  
→ Refer to the FX3UC Series User's Manual - Hardware Edition

**2.2 Mounting**

The product is mounted by the following method.

- Direct mounting
- DIN rail mounting

**2.2.1 Direct Mounting**

The product can be mounted with M4 screws by using the direct mounting holes. Refer to the External Dimensions (section 1.2) for the product's mounting hole pitch information. An interval space between each unit of 1 to 2 mm (0.04" to 0.08") is necessary. For further information of direct installation, also refer to the following manual.  
→ Refer to the FX3U Series User's Manual - Hardware Edition  
→ Refer to the FX3UC Series User's Manual - Hardware Edition

**2.2.2 DIN Rail Mounting**

The product can be mounted on a DIN rail (DIN46227, 35mm width).

- 1) Fit the upper edge of the DIN rail mounting groove (fig. A) onto the DIN rail.
- 2) Press the product against the DIN rail.

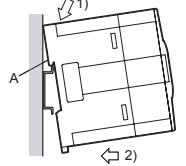

- 3) Connect the extension cable (fig. B) to the main unit, input/output extension unit/block, and special function unit/block on the left. For the details of the extension cable connection, refer to the following manual.  
→ Refer to the FX3U Series User's Manual - Hardware Edition  
→ Refer to the FX3UC Series User's Manual - Hardware Edition

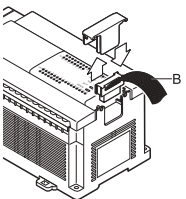

**3. Wiring**

**WIRING PRECAUTIONS**

- Make sure to cut off all phases of the power supply externally before attempting installation or wiring work. Failure to do so may cause electric shock or damage to the product.

**WIRING PRECAUTIONS**

- Make sure to observe the following precautions in order to prevent any damage to the machinery or accidents due to abnormal data written to the PLC under the influence of noise:
  - 1) Do not bundle the power line or twisted shielded cable together with or lay it close to the main circuit, high-voltage line or load line. Otherwise, noise disturbance and/or surge induction are likely to take place. As a guideline, lay the control line 100mm (3.94") or more away from the main circuit, high-voltage line, or load line.
  - 2) Ground the shield wire or shield of the shielded cable at one point on the PLC. However, do not use common grounding with heavy electrical systems.

**WIRING PRECAUTIONS** **CAUTION**

- Make sure to properly wire to the terminal blocks in accordance with the following precautions. Failure to do so may cause electric shock, equipment failures, a short-circuit, wire breakage, malfunctions, or damage to the product.
  - The disposal size of the cable end should follow the dimensions described in the manual.
  - Tightening torque should follow the specification in the manual.
  - Tighten the screws using a Phillips-head screwdriver No.2 (shaft diameter 6mm (0.24") or less). Make sure that the screwdriver does not touch the partition part of the terminal block.

### 3.1 Applicable Cable and Terminal Tightening Torque

The size of the terminal screws is M3. The end disposal of the cable shows below. Tighten the terminal to a torque of 0.5 to 0.8N·m. Do not tighten terminal screws exceeding with a torque outside the abovementioned range.

Failure to do so may cause equipment failures or malfunctions.

- When one wire is connected to one terminal

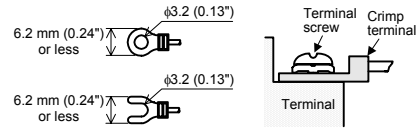

- When two wires are connected to one terminal

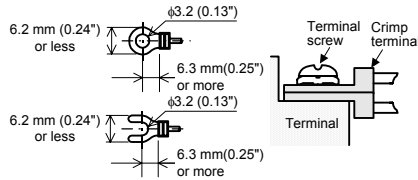

### 3.2 Power Supply Wiring

For the power supply wiring, refer to the following manual. → Refer to the FX3s/FX3g/FX3gc/FX3u/FX3uc Series User's Manual - Analog Control Edition

### 3.3 Wiring of Analog Input

→ For the terminal layout, refer to Subsection 1.2.2

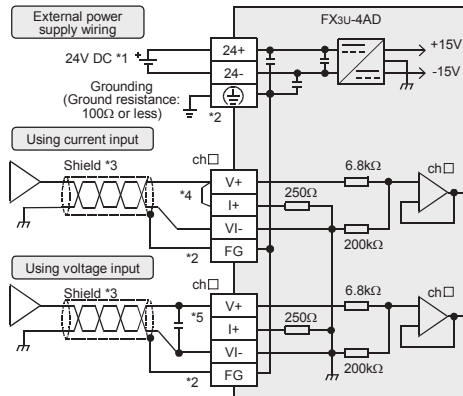

ch□ : □ represents the channel number.

- For FX3u Series PLC (AC power type), the 24V DC service power supply is also available.
- The [FG] terminal and the [⊕] terminal are connected internally. There is no "FG" terminal for ch1. When using ch1, connect directly to the [⊕] terminal.
- Use a 2-core twisted shield wire for analog input line, and separate it from other power lines or inductive lines.
- For the current input, short-circuit the [V+] terminal and the [I+] terminal.
- If there is voltage ripple in the input voltage or there is noise in the external wiring, connect a capacitor of approximately 0.1 to 0.47μF 25 V.

### 3.4 Grounding

- Grounding should be performed as stated below.
- The grounding resistance should be 100Ω or less.
  - Independent grounding should be performed for best results. When independent grounding is not performed, perform "shared grounding" of the following figure.
    - For details, refer to the FX3u Series User's Manual - Hardware Edition.
    - For details, refer to the FX3uc Series User's Manual - Hardware Edition.

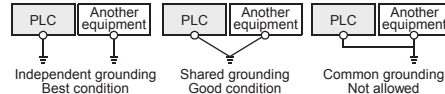

- The grounding wire size should be AWG 14 (2 mm<sup>2</sup>).
- The grounding point should be close to the PLC, and all grounding wire should be as short as possible.

### 4. Specifications

**STARTUP AND MAINTENANCE PRECAUTIONS** **CAUTION**

- Do not disassemble or modify the PLC. Doing so may cause fire, equipment failures, or malfunctions. \* For repair, contact your local Mitsubishi Electric representative.
- Do not drop the product or exert strong impact to it. Doing so may cause damage.

**DISPOSAL PRECAUTIONS** **CAUTION**

- Please contact a certified electronic waste disposal company for the environmentally safe recycling and disposal of your device.

**TRANSPORTATION AND STORAGE PRECAUTIONS** **CAUTION**

- The product is a precision instrument. During transportation, avoid impacts larger than those specified in the general specifications by using dedicated packaging boxes and shock-absorbing pallets. Failure to do so may cause failures in the product. After transportation, verify operation of the product and check for damage of the mounting part, etc.

### 4.1 Applicable PLC

Model name	Applicability
FX3u Series PLC	Ver. 2.20 or later (from first production) Up to 8 blocks can be extended
FX3uc Series PLC*1	Ver. 1.30 or later (from the production manufactured in August, 2004 with SER No. 48□□□□) Up to 8 blocks can be extended*2

The version number can be checked by monitoring D8001 as the last three digits indicate it.

\*1 An FX2NC-CNV-IF or FX3uc-1PS-5V is necessary to connect the FX3u-4AD with the FX3uc PLC.

\*2 Up to 7 units can be connected to the FX3uc-3ZMT-LT(-) PLC.

### 4.2 General Specifications

For the general specifications other than the following, refer to the manual of the PLC main unit. The items other than the following are equivalent to those of the PLC main unit.

- For details, refer to the FX3u Series User's Manual - Hardware Edition.
- For details, refer to the FX3uc Series User's Manual - Hardware Edition.

Item	Specification
<b>Dielectric withstand voltage</b>	500V AC for one minute Between all terminals and ground terminal of PLC main unit
<b>Insulation resistance</b>	5MΩ or more by 500V DC megger

### 4.3 Power Supply Specifications

Item	Specification
<b>A/D conversion circuit driving power</b>	24V DC ±10%, 90mA (24V DC power is supplied from the power connector.)
<b>CPU driving power</b>	5V DC, 110mA (5V DC power is supplied from the internal power supply of main unit.)

### 4.4 Performance Specifications

Item	Description	
	Voltage input	Current input
<b>Analog input range</b>	-10 to +10V DC (Input resistance: 200 kΩ)	-20 to +20mA, 4 to 20mA DC (Input resistance: 250 Ω)
<b>Offset*1</b>	-10 to +9V <sup>2</sup>	-20 to +17mA <sup>3</sup>
<b>Gain*1</b>	-9 to +10V <sup>2</sup>	-17 to +30mA <sup>3</sup>
<b>Maximum absolute input</b>	±15V	±30mA
<b>Digital output</b>	With sign, 16bits, binary	With sign, 15bits, binary
<b>Resolution</b>	0.32mV (20V/64000)	1.25μA (40mA/32000)
<b>Total accuracy</b>	<ul style="list-style-type: none"> <li>±0.3% (±60mV) for full scale of 20V (when ambient temperature is 25°C±5°C)</li> <li>±0.5% (±100mV) for full scale of 20V (when ambient temperature is 0°C to 55°C)</li> </ul>	<ul style="list-style-type: none"> <li>±0.5% (±200μA) for full scale of 40mA (when ambient temperature is 25°C±5°C and a current of -20 mA to +20 mA is input) Same when input is 4mA to 20mA</li> <li>±1.0% (±400μA) for full scale of 40mA (when ambient temperature is 25°C±5°C and a current of -20 mA to +20 mA is input) Same when input is 4mA to 20mA</li> </ul>
<b>A/D conversion time</b>	500μs × number of selected channels (If channels use the digital filter(s): 5ms × number of selected channels)	
<b>Input characteristics*4</b>	<ul style="list-style-type: none"> <li>Input mode 0  </li> <li>Input mode 3  </li> <li>Input mode 6  </li> </ul>	
<b>Insulation method</b>	<ul style="list-style-type: none"> <li>The photo-coupler insulates the analog input area from the PLC.</li> <li>The DC-DC converter insulates the analog input area from the power supply unit.</li> <li>Channels are not insulated from each other.</li> </ul>	
<b>Occupied points</b>	8 point (Count either the input or output points of the PLC.)	

\*1 Change the offset and gain values to change the input characteristics. However, the resolution doesn't change even when the offset and gain values change. When the analog value direct indication is enabled in the input mode 2, 5, or 8, the offset value and the gain value don't change.

\*2 The offset and the gain should satisfy the following condition:  
1V ≤ (Gain - Offset) ≤ 7.5V

\*3 The offset and the gain should satisfy the following condition:  
3mA ≤ (Gain - Offset) ≤ 30mA

\*4 The input characteristics vary depending on the input mode to be used. For the details of the input characteristics, refer to the following manual.

→ Refer to the FX3s/FX3g/FX3gc/FX3u/FX3uc Series User's Manual - Analog Control Edition

### 4.5 Input characteristics

The input characteristics in each input mode are as follows. For the details of the input characteristics, refer to the following manual. → Refer to the FX3s/FX3g/FX3gc/FX3u/FX3uc Series User's Manual - Analog Control Edition

Input mode	Input mode	Analog input range	Digital output range
0	Voltage input mode	-10 to +10V	-32000 to +32000
1	Voltage input mode	-10 to +10V	-4000 to +4000
2	Voltage input mode Analog value direct indication	-10 to +10V	-10000 to +10000
3	Current input mode	4 to 20mA	0 to 16000
4	Current input mode	4 to 20mA	0 to 4000
5	Current input mode Analog value direct indication	4 to 20mA	4000 to 20000
6	Current input mode	-20 to +20mA	-16000 to +16000
7	Current input mode	-20 to +20mA	-4000 to +4000
8	Current input mode Analog value direct indication	-20 to +20mA	-20000 to +20000

This manual confers no industrial property rights or any rights of any other kind, nor does it confer any patent licenses. Mitsubishi Electric Corporation cannot be held responsible for any problems involving industrial property rights which may occur as a result of using the contents noted in this manual.

### Warranty

Exclusion of loss in opportunity and secondary loss from warranty liability. Regardless of the gratis warranty term, Mitsubishi shall not be liable for compensation to: (1) Damages caused by any cause found not to be the responsibility of Mitsubishi. (2) Loss in opportunity, lost profits incurred to the user by Failures of Mitsubishi products. (3) Special damages and secondary damages whether foreseeable or not, compensation for accidents, and compensation for damages to products other than Mitsubishi products. (4) Replacement by the user, maintenance of on-site equipment, start-up test run and other tasks.

**CAUTION For safe use**

- This product has been manufactured as a general-purpose part for general industries, and has not been designed or manufactured to be incorporated in a device or system used in purposes related to human life.
- Before using the product for special purposes such as nuclear power, electric power, aerospace, medicine or passenger movement vehicles, consult with Mitsubishi Electric.
- This product has been manufactured under strict quality control. However when installing the product where major accidents or losses could occur if the product fails, install appropriate backup or failsafe functions in the system.



PROGRAMMABLE CONTROLLERS  
MELSEC-F

Side A JAPANESE  
Side B ENGLISH

FX3U-4AD

INSTALLATION MANUAL



Manual Number	JY997D20701
Revision	E
Date	March 2016

This manual describes the part names, dimensions, mounting, and specifications of the product. Before use, read this manual and the manuals of all relevant products fully to acquire proficiency in handling and operating the product. Make sure to learn all the product information, safety information, and precautions. Store this manual in a safe place so that it can be taken out and read whenever necessary. Always forward it to the end user.

Registration:  
Phillips is a registered trademark of Phillips Screw Company. The company and product names described in this manual are registered trademarks or the trademarks of their respective companies.

Effective March 2016  
Specifications are subject to change without notice.  
© 2006 MITSUBISHI ELECTRIC CORPORATION

Safety Precaution (Read these precautions before use.)

This manual classifies the safety precautions into two categories:

⚠ WARNING and ⚠ CAUTION

<b>WARNING</b>	Indicates that incorrect handling may cause hazardous conditions, resulting in death or severe injury.
<b>CAUTION</b>	Indicates that incorrect handling may cause hazardous conditions, resulting in medium or slight personal injury or physical damage.

Depending on the circumstances, procedures indicated by ⚠ CAUTION may also cause severe injury. It is important to follow all precautions for personal safety.

Associated Manuals

Manual name	Manual No.	Description
FX3S/FX3G/FX3GC/FX3U/FX3UC Series User's Manual - Analog Control Edition	JY997D16701 MODEL CODE: 09R619	Describes specifications for analog control and programming method for FX3S/FX3G/FX3GC/FX3U/FX3UC Series PLC.
FX3S/FX3G/FX3GC/FX3U/FX3UC Series Programming Manual - Basic & Applied Instruction Edition	JY997D16601 MODEL CODE: 09R517	Describes PLC programming for basic/applied instructions and devices.
FX3G Series User's Manual - Hardware Edition	JY997D31301 MODEL CODE: 09R521	Explains the FX3G Series PLC specifications for I/O, wiring, installation, and maintenance.
FX3U Series User's Manual - Hardware Edition	JY997D16501 MODEL CODE: 09R516	Explains the FX3U Series PLC specifications for I/O, wiring, installation, and maintenance.
FX3UC Series User's Manual - Hardware Edition	JY997D28701 MODEL CODE: 09R519	Explains the FX3UC Series PLC specifications for I/O, wiring, installation, and maintenance.

How to obtain manuals

For product manuals or documents, consult with the Mitsubishi Electric dealer from who you purchased your product.

Certification of UL, cUL standards

The following product has UL and cUL certification.  
UL File Number: E95239  
Models: MELSEC FX3U series manufactured FX3U-4AD

Compliance with EC directive (CE Marking)

This note does not guarantee that an entire mechanical module produced in accordance with the contents of this note will comply with the following standards. Compliance to EMC directive and LVD directive for the entire mechanical module should be checked by the user / manufacturer. For more details please contact the local Mitsubishi Electric sales site.

Requirement for Compliance with EMC directive

The following products have shown compliance through direct testing (of the identified standards below) and design analysis (through the creation of a technical construction file) to the European Directive for Electromagnetic Compatibility (2004/108/EC) when used as directed by the appropriate documentation.

Attention  
This product is designed for use in industrial applications.

Type: Programmable Controller (Open Type Equipment)

Models: MELSEC FX3U series manufactured from February 1st, 2006 FX3U-4AD

Standard	Remark
EN61131-2:2007 Programmable controllers - Equipment requirements and tests	Compliance with all relevant aspects of the standard.
EMC	<ul style="list-style-type: none"> <li>• Radiated Emission</li> <li>• Conducted Emission</li> </ul>
EMS	<ul style="list-style-type: none"> <li>• Radiated electromagnetic field</li> <li>• Fast transient burst</li> <li>• Electrostatic discharge</li> <li>• High-energy surge</li> <li>• Voltage drops and interruptions</li> <li>• Conducted RF</li> <li>• Power frequency magnetic field</li> </ul>

Caution for EC Directive

The FX3U-4AD has been found to be compliant to the European standards in the aforesaid manual and directive. However, for the very best performance from what are in fact delicate measuring and controlled output device Mitsubishi Electric would like to make the following points:  
As analog devices are sensitive by nature, their use should be considered carefully. For users of proprietary cables (integral with sensors or actuators), these users should follow those manufacturers installation requirements. Mitsubishi Electric recommend that shielded cables should be used. If NO other EMC protection is provided, then users may experience temporary loss or accuracy between ±10% in very heavy industrial areas. However, Mitsubishi Electric suggest that if adequate EMC precautions are followed for the users complete control system, users should expect accuracy as specified in this manual.

- Sensitive analog cable should not be laid in the same trunking or cable conduit as high voltage cabling. Where possible users should run analog cables separately.
- Good cable shielding should be used. Ground the shield of the twisted shielded cable at one point on the PLC side.
- When reading analog values, EMC accuracy can be improved out by averaging the readings. This can be achieved either through functions on the special function block for analog input or through a users program in the FX3U Series PLC main unit.
- Please use FX3U-4AD while installed in a shielded enclosure. For the details, refer to the following manual.  
→ Refer to the FX3U Series User's Manual - Hardware Edition  
→ Refer to the FX3UC Series User's Manual - Hardware Edition

Note for compliance with EN61131-2:2007

General note on the use of the power supply cable.  
The FX3U-4AD unit requires that the cable used for power supply is 30m or less.

1. Outline

The FX3U-4AD special function block for analog input converts four analog input values (voltage, current) to digital values and transfers those digital values to the PLC main unit.

1.1 Incorporated Items

Verify that if the following product and items are included in the package:

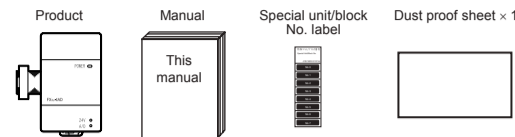

1.2 External Dimensions, Part Names, and Terminal Layout

1.2.1 External Dimensions and Part Names

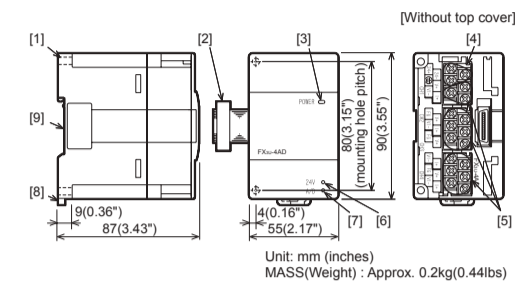

- Direct mounting hole: 2 holes of φ4.5 (0.18") (mounting screw: M4 screw)
- Extension cable
- POWER LED (green):  
Lit while 5V DC power is supplied from PLC.
- Terminal block for power supply (24V DC) (M3 terminal screw)
- Terminal block for analog input
- 24V LED (red):  
Lit while 24V DC power is supplied properly to terminals [24+] and [24-].
- A/D LED (red): Flashes (at high speed) during A/D conversion.
- DIN rail mounting hook
- DIN rail mounting groove (35 mm (1.38") wide)

1.2.2 Terminal Layout

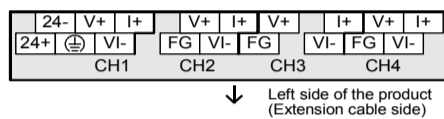

2. Installation

INSTALLATION PRECAUTIONS

- Use the product within the generic environment specifications described in PLC main unit manual (Hardware Edition).  
Never use the product in areas with excessive dust, oily smoke, conductive dusts, corrosive gas (salt air, Cl<sub>2</sub>, H<sub>2</sub>S, SO<sub>2</sub>, or NO<sub>2</sub>), flammable gas, vibration or impacts, or expose it to high temperature, condensation, or rain and wind.  
If the product is used in such conditions, electric shock, fire, malfunctions, deterioration or damage may occur.
- Do not touch the conductive parts of the product directly.  
Doing so may cause device failures or malfunctions.
- Install the product securely using a DIN rail or mounting screws.
- Install the product on a flat surface.  
If the mounting surface is rough, undue force will be applied to the PC board, thereby causing nonconformities.
- When drilling screw holes or wiring, make sure cutting or wire debris does not enter the ventilation slits.  
Failure to do so may cause fire, equipment failures or malfunctions.

INSTALLATION PRECAUTIONS

CAUTION

- Be sure to remove the dust proof sheet from the PLC's ventilation port when installation work is completed.  
Failure to do so may cause fire, equipment failures or malfunctions.
- Connect extension cables securely to their designated connectors.  
Loose connections may cause malfunctions.

2.1 Arrangements

The product connects on the right side of a PLC main unit or extension units/blocks (including special function units/blocks).  
For connection to FX3UC Series PLC or FX2NC Series PLC extension block, FX2NC-CNV-IF or FX3UC-1PS-5V is required.  
For further information of installation arrangements, refer to the following manual.  
→ Refer to the FX3U Series User's Manual - Hardware Edition  
→ Refer to the FX3UC Series User's Manual - Hardware Edition

2.2 Mounting

The product is mounted by the following method.

- Direct mounting
- DIN rail mounting

2.2.1 Direct Mounting

The product can be mounted with M4 screws by using the direct mounting holes. Refer to the External Dimensions (section 1.2) for the product's mounting hole pitch information.  
An interval space between each unit of 1 to 2 mm (0.04" to 0.08") is necessary.  
For further information of direct installation, also refer to the following manual.  
→ Refer to the FX3U Series User's Manual - Hardware Edition  
→ Refer to the FX3UC Series User's Manual - Hardware Edition

2.2.2 DIN Rail Mounting

The product can be mounted on a DIN rail (DIN46227, 35mm width).

- Fit the upper edge of the DIN rail mounting groove (fig. A) onto the DIN rail.
- Press the product against the DIN rail.

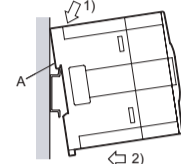

- Connect the extension cable (fig. B) to the main unit, input/output extension unit/block, and special function unit/block on the left.  
For the details of the extension cable connection, refer to the following manual.  
→ Refer to the FX3U Series User's Manual - Hardware Edition  
→ Refer to the FX3UC Series User's Manual - Hardware Edition

3. Wiring

WIRING PRECAUTIONS

WARNING

- Make sure to cut off all phases of the power supply externally before attempting installation or wiring work.  
Failure to do so may cause electric shock or damage to the product.

WIRING PRECAUTIONS

CAUTION

- Make sure to observe the following precautions in order to prevent any damage to the machinery or accidents due to abnormal data written to the PLC under the influence of noise:
  - Do not bundle the power line or twisted shielded cable together with or lay it close to the main circuit, high-voltage line or load line.  
Otherwise, noise disturbance and/or surge induction are likely to take place. As a guideline, lay the control line 100mm (3.94") or more away from the main circuit, high-voltage line, or load line.
  - Ground the shield wire or shield of the shielded cable at one point on the PLC. However, do not use common grounding with heavy electrical systems.

WIRING PRECAUTIONS

CAUTION

- Make sure to properly wire to the terminal blocks in accordance with the following precautions.  
Failure to do so may cause electric shock, equipment failures, a short-circuit, wire breakage, malfunctions, or damage to the product.
  - The disposal size of the cable end should follow the dimensions described in the manual.
  - Tightening torque should follow the specification in the manual.
  - Tighten the screws using a Phillips-head screwdriver No.2 (shaft diameter 6mm (0.24") or less). Make sure that the screwdriver does not touch the partition part of the terminal block.

3.1 Applicable Cable and Terminal Tightening Torque

The size of the terminal screws is M3.  
The end disposal of the cable shows below.  
Tighten the terminal to a torque of 0.5 to 0.8N·m.  
Do not tighten terminal screws exceeding with a torque outside the abovementioned range.

Failure to do so may cause equipment failures or malfunctions.

- When one wire is connected to one terminal

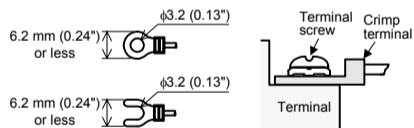

- When two wires are connected to one terminal

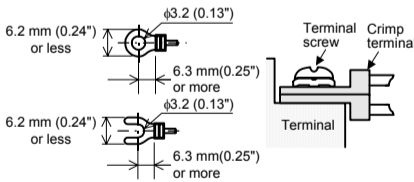

3.2 Power Supply Wiring

For the power supply wiring, refer to the following manual.

→ Refer to the FX3S/FX3G/FX3GC/FX3U/FX3UC Series User's Manual - Analog Control Edition

3.3 Wiring of Analog Input

→ For the terminal layout, refer to Subsection 1.2.2

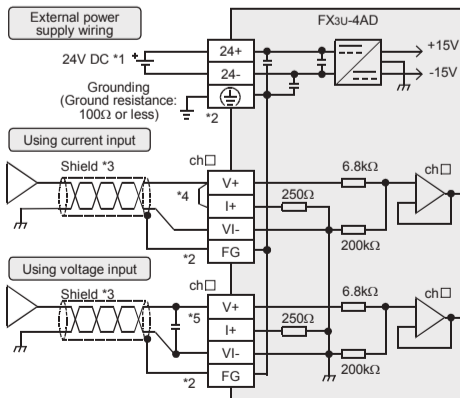

ch□: □ represents the channel number.

\*1 For FX3U Series PLC (AC power type), the 24V DC service power supply is also available.

\*2 The [FG] terminal and the [⊕] terminal are connected internally. There is no "FG" terminal for ch1. When using ch1, connect directly to the [⊕] terminal.

\*3 Use a 2-core twisted shield wire for analog input line, and separate it from other power lines or inductive lines.

\*4 For the current input, short-circuit the [V+] terminal and the [I+] terminal.

\*5 If there is voltage ripple in the input voltage or there is noise in the external wiring, connect a capacitor of approximately 0.1 to 0.47μF 25 V.

3.4 Grounding

Grounding should be performed as stated below.

- The grounding resistance should be 100Ω or less.
- Independent grounding should be performed for best results.  
When independent grounding is not performed, perform "shared grounding" of the following figure.

→ For details, refer to the FX3U Series User's Manual - Hardware Edition.  
→ For details, refer to the FX3UC Series User's Manual - Hardware Edition.

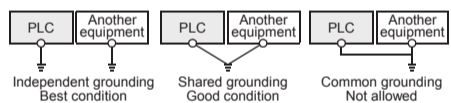

- The grounding wire size should be AWG 14 (2 mm<sup>2</sup>).
- The grounding point should be close to the PLC, and all grounding wire should be as short as possible.

4. Specifications

STARTUP AND MAINTENANCE PRECAUTIONS

- Do not disassemble or modify the PLC.  
Doing so may cause fire, equipment failures, or malfunctions.  
\* For repair, contact your local Mitsubishi Electric representative.
- Do not drop the product or exert strong impact to it.  
Doing so may cause damage.

DISPOSAL PRECAUTIONS

- Please contact a certified electronic waste disposal company for the environmentally safe recycling and disposal of your device.

TRANSPORTATION AND STORAGE PRECAUTIONS

- The product is a precision instrument. During transportation, avoid impacts larger than those specified in the general specifications by using dedicated packaging boxes and shock-absorbing pallets.  
Failure to do so may cause failures in the product.  
After transportation, verify operation of the product and check for damage of the mounting part, etc.

4.1 Applicable PLC

Model name	Applicability
FX3U Series PLC	Ver. 2.20 or later (from first production) Up to 8 blocks can be extended
FX3UC Series PLC <sup>1</sup>	Ver. 1.30 or later (from the production manufactured in August, 2004 with SER No. 48□□□□) Up to 8 blocks can be extended <sup>2</sup>

The version number can be checked by monitoring D8001 as the last three digits indicate it.

<sup>1</sup> An FX2NC-CNV-IF or FX3UC-1PS-5V is necessary to connect the FX3U-4AD with the FX3UC PLC.

<sup>2</sup> Up to 7 units can be connected to the FX3UC-32MT-LT(-2) PLC.

4.2 General Specifications

For the general specifications other than the following, refer to the manual of the PLC main unit.

The items other than the following are equivalent to those of the PLC main unit.  
→ For details, refer to the FX3U Series User's Manual - Hardware Edition.

→ For details, refer to the FX3UC Series User's Manual - Hardware Edition.

Item	Specification
Dielectric withstand voltage	500V AC for one minute Between all terminals and ground terminal of PLC main unit
Insulation resistance	5MΩ or more by 500V DC megger

4.3 Power Supply Specifications

Item	Specification
A/D conversion circuit driving power	24V DC ±10%, 90mA (24V DC power is supplied from the power connector.)
CPU driving power	5V DC, 110mA (5V DC power is supplied from the internal power supply of main unit.)

4.4 Performance Specifications

Item	Description	
	Voltage input	Current input
Analog input range	-10 to +10V DC (Input resistance: 200 kΩ)	-20 to +20mA, 4 to 20mA DC (Input resistance: 250 Ω)
Offset <sup>1</sup>	-10 to +9V <sup>2</sup>	-20 to +17mA <sup>3</sup>
Gain <sup>1</sup>	-9 to +10V <sup>2</sup>	-17 to +30mA <sup>3</sup>
Maximum absolute input	±15V	±30mA
Digital output	With sign, 16bits, binary	With sign, 15bits, binary
Resolution	0.32mV (20V/64000)	1.25μA (40mA/32000)
Total accuracy	<ul style="list-style-type: none"> <li>• ±0.3% (±60mV) for full scale of 20V (when ambient temperature is 25°C±5°C)</li> <li>• ±0.5% (±100mV) for full scale of 20V (when ambient temperature is 0°C to 55°C)</li> </ul>	<ul style="list-style-type: none"> <li>• ±0.5% (±200μA) for full scale of 40mA (when ambient temperature is 25°C±5°C and a current of -20 mA to +20 mA is input) Same when input is 4mA to 20mA</li> <li>• ±1.0% (±400μA) for full scale of 40mA (when ambient temperature is 25°C±5°C and a current of -20 mA to +20 mA is input) Same when input is 4mA to 20mA</li> </ul>
A/D conversion time	500μs × number of selected channels (If channels use the digital filter(s): 5ms × number of selected channels)	
Input characteristics		

<sup>1</sup> The photo-coupler insulates the analog input area from the PLC.  
<sup>2</sup> The DC-DC converter insulates the analog input area from the power supply unit.  
<sup>3</sup> Channels are not insulated from each other.

<sup>4</sup> The input characteristics vary depending on the input mode to be used.  
For the details of the input characteristics, refer to the following manual.  
→ Refer to the FX3S/FX3G/FX3GC/FX3U/FX3UC Series User's Manual - Analog Control Edition

4.5 Input characteristics

The input characteristics in each input mode are as follows.  
For the details of the input characteristics, refer to the following manual.  
→ Refer to the FX3S/FX3G/FX3GC/FX3U/FX3UC Series User's Manual - Analog Control Edition

Input mode	Input mode	Analog input range	Digital output range
0	Voltage input mode	-10 to +10V	-32000 to +32000
1	Voltage input mode	-10 to +10V	-4000 to +4000
2	Voltage input mode Analog value direct indication	-10 to +10V	-10000 to +10000
3	Current input mode	4 to 20mA	0 to 16000
4	Current input mode	4 to 20mA	0 to 4000
5	Current input mode Analog value direct indication	4 to 20mA	4000 to 20000
6	Current input mode	-20 to +20mA	-16000 to +16000
7	Current input mode	-20 to +20mA	-4000 to +4000
8	Current input mode Analog value direct indication	-20 to +20mA	-20000 to +20000

This manual confers no industrial property rights or any rights of any other kind, nor does it confer any patent licenses. Mitsubishi Electric Corporation cannot be held responsible for any problems involving industrial property rights which may occur as a result of using the contents noted in this manual.

Warranty  
Exclusion of loss in opportunity and secondary loss from warranty liability  
Regardless of the gratis warranty term, Mitsubishi shall not be liable for compensation to:

- Damages caused by any cause found not to be the responsibility of Mitsubishi.
- Loss in opportunity, lost profits incurred to the user by Failures of Mitsubishi products.
- Special damages and secondary damages whether foreseeable or not, compensation for accidents, and compensation for damages to products other than Mitsubishi products.
- Replacement by the user, maintenance of on-site equipment, start-up test run and other tasks.

For safe use

- This product has been manufactured as a general-purpose part for general industries, and has not been designed or manufactured to be incorporated in a device or system used in purposes related to human life.
- Before using the product for special purposes such as nuclear power, electric power, aerospace, medicine or passenger movement vehicles, consult with Mitsubishi Electric.
- This product has been manufactured under strict quality control. However when installing the product where major accidents or losses could occur if the product fails, install appropriate backup or failsafe functions in the system.

MITSUBISHI ELECTRIC CORPORATION

HEAD OFFICE : TOKYO BUILDING, 2-7-3 MARUNOUCHI, CHIYODA-KU, TOKYO 100-8310, JAPAN