

MITSUBISHI PROGRAMMABLE CONTROLLERS MELSEC-F

FX3U-1PSU-5V

INSTALLATION MANUAL

Manual Number	JY997D22501
Revision	D
Date	September 2010

This manual describes the part names, dimensions, installation, wiring and specifications of the product. Before use, read this manual and manuals of relevant products fully to acquire proficiency in handling and operating the product. Make sure to learn all the product information, safety information, and precautions. And, store this manual in a safe place so that you can take it out and read it whenever necessary. Always forward it to the end user. Registration The company name and the product name to be described in this manual are the registered trademarks or trademarks of each company.

Effective September 2010
Specifications are subject to change without notice.

© 2006 Mitsubishi Electric Corporation

Safety Precautions (Read these precautions before use.)

This manual classifies the safety precautions into two categories:

⚠DANGER and **⚠CAUTION**.

⚠DANGER	Indicates that incorrect handling may cause hazardous conditions, resulting in death or severe injury.
⚠CAUTION	Indicates that incorrect handling may cause hazardous conditions, resulting in medium or slight personal injury or physical damage.

Depending on circumstances, procedures indicated by **⚠CAUTION** may also be linked to serious results. Therefore, it is important to follow the directions for usage.

Associated Manuals

Manual name	Manual No.	Description
FX3G Series User's Manual - Hardware Edition	JY997D31301 MODEL CODE: 09R521	Explains FX3G Series PLC specification details for I/O, wiring, installation, and maintenance.
FX3U Series User's Manual - Hardware Edition	JY997D16501 MODEL CODE: 09R516	Explains FX3U Series PLC specification details for I/O, wiring, installation, and maintenance.

How to obtain manuals

For the necessary product manuals or documents, consult with the Mitsubishi Electric dealer from where you purchase your product.

Certification of UL, cUL standards

FX3U-1PSU-5V units comply with the UL standards (UL, cUL)

UL, cUL registration number: **E95239**

Regarding the standards that comply with the main unit, please refer to either the FX series product catalog or consult with your nearest Mitsubishi product provider.

Compliance with EC directive (CE Marking)

This note does not guarantee that an entire mechanical module produced in accordance with the contents of this note will comply with the following standards. Compliance to EMC directive and LVD directive for the entire mechanical module should be checked by the user / manufacturer. For more information please consult with your nearest Mitsubishi product provider.

Regarding the standards that comply with the main unit, please refer to either the FX series product catalog or consult with your nearest Mitsubishi product provider.

Attention

- This product is designed for use in industrial applications.

Note

- Manufactured by: Mitsubishi Electric Corporation
2-7-3 Marunouchi, Chiyoda-ku, Tokyo, 100-8310 Japan
- Manufactured at: Mitsubishi Electric Corporation Himeji Works
840 Chiyoda-machi, Himeji, Hyogo, 670-8677 Japan
- Authorized Representative in the European Community:
Mitsubishi Electric Europe B.V.
Gothaer Str. 8, 40880 Ratingen, German

Requirement for Compliance with EMC directive

The following products have shown compliance through direct testing (of the identified standards below) and design analysis (through the creation of a technical construction file) to the European Directive for Electromagnetic Compatibility (2004/108/EC) when used as directed by the appropriate documentation.

Type: **Programmable Controller (Open Type Equipment)**

Models: **MELSEC FX3U series manufactured from February 1st, 2006** FX3U-1PSU-5V

Standard	Remark
EN61131-2:2007 Programmable controllers - Equipment requirements and tests	Compliance with all relevant aspects of the standard. EMI • Radiated Emissions • Conducted Emissions EMS • Radiated electromagnetic field • Fast transient burst • Electrostatic discharge • High-energy surge • Voltage drops and interruptions • Conducted RF • Power frequency magnetic field

Requirement for Compliance with LVD directive

The following products have shown compliance through direct testing (of the identified standards below) and design analysis (through the creation of a technical construction file) to the European Directive for Low Voltage (2006/95/EC) when used as directed by the appropriate documentation.

Type: **Programmable Controller (Open Type Equipment)**

Models: **MELSEC FX3U series manufactured from February 1st, 2006** FX3U-1PSU-5V

Standard	Remark
EN61131-2:2007 Programmable controllers - Equipment requirements and tests	The equipment has been assessed as a component for fitting in a suitable enclosure which meets the requirements of EN61131-2:2007

1. Introduction

When the FX3G, FX3U internal power supplied from the FX3G, FX3U PLC (AC power supply type) is insufficient for powering the output extension blocks or special function blocks, the FX3U-1PSU-5V (extension power supply unit) is available. Up to two FX3U-1PSU-5V units may be connected to a FX3U PLC system. Only one FX3U-1PSU-5V unit may be connected to a FX3G PLC system. Connect extension equipment to the FX3U-1PSU-5V according to the configuration specification limits described in the following manuals.

For details on installation and wiring, and system configuration with the FX3G and FX3U Series PLC including the FX3U-1PSU-5V, refer to the following manuals.

→ **FX3G Series User's Manual - Hardware Edition**
→ **FX3U Series User's Manual - Hardware Edition**

1.1 Incorporated Items

Check that the following product and items are included in the package:

Product	FX3U-1PSU-5V extension power supply unit
Accessories	Dust proof protection sheet Extension cable Installation manual (This manual)

1.2 External Dimensions and Part Names

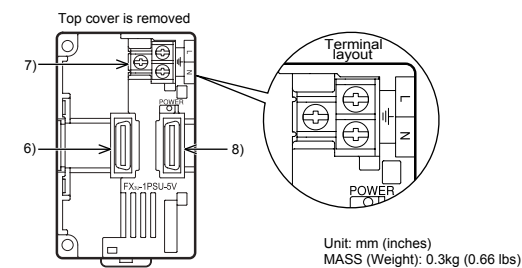
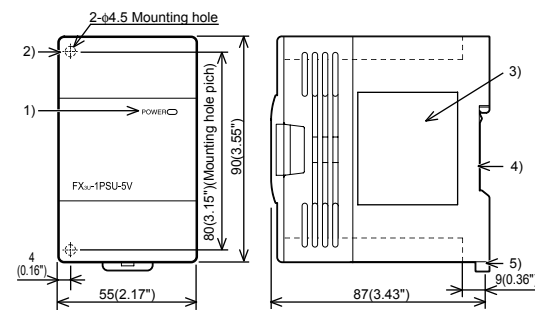

Unit: mm (inches)
MASS (Weight): 0.3kg (0.66 lbs)

- POWER LED (green)
- Direct mounting hole: 2 holes of ø4.5 (0.18") (mounting screw: M4 screw)
- Name plate
- DIN rail mounting groove (DIN rail: DIN46277)
- DIN rail mounting hook
- Extension connector for preceding unit/block
- Power supply terminal block
- Extension connector for next unit/block

2. Installation

INSTALLATION PRECAUTIONS **⚠DANGER**

- Cut off all phases of the power source externally before starting the installation work, thus avoiding electric shock or damages to the product.

INSTALLATION PRECAUTIONS **⚠CAUTION**

- Use the product in the environment within the general specifications described in the PLC main unit manual (Hardware Edition). Never use the product in areas with dust, oily smoke, conductive dusts, corrosive gas (salt air, Cl₂, H₂S, SO₂, or NO₂), flammable gas, vibrations or impacts, or expose it to high temperature, condensation, or wind and rain. If the product is used in such a place described above, electrical shock, fire, malfunction, damage, or deterioration may be caused.
- Do not touch the conductive parts of the product directly, in order to avoid electrical shock, failure or malfunction.
- Install the product securely using the DIN rail or screws.
- Install the product on a flat surface. If the mounting surface is rough, undue force will be applied to the PC board, thereby causing nonconformity.
- When drilling screw holes or wiring, cutting chips or wire chips should not enter ventilation slits. This may cause fire, failures, or malfunctions.
- Be sure to remove the dust proof sheet from the PLC's ventilation port when the installation work is completed. Failure to do so could cause fires, equipment failures, and malfunctions.
- Fit the extension cables and communication cables securely to the designated connectors. Contact failures may cause malfunctions.

2.1 Arrangements

The product connects on the right side of an PLC main unit, input/output extension unit/block or special function unit/block. For further information of installation arrangements, refer to the following manual.
→ **FX3G Series User's Manual - Hardware Edition**
→ **FX3U Series User's Manual - Hardware Edition**

2.2 Mounting

The product is mounted by the following method.

- Direct mounting
- DIN rail mounting

2.2.1 Direct Mounting

The product can be mounted with M4 screws by using the direct mounting holes. Refer to the External Dimensions (section 1.2) for the product's mounting hole pitch information.

An internal space between each unit of 1 to 2 mm (0.04" to 0.08") is necessary. For further information on direct installation, also refer to the following manual.
→ **FX3G Series User's Manual - Hardware Edition**
→ **FX3U Series User's Manual - Hardware Edition**

2.2.2 DIN Rail Mounting

The product can be mounted on a DIN rail (DIN46227, 35mm width).

1) Connect the extension cable (right fig. A) to the main unit, input/output extension unit/block and special function unit/block on the left. For details on the extension cable connection, refer to the following manual.
→ **FX3G Series User's Manual - Hardware Edition**
→ **FX3U Series User's Manual - Hardware Edition**

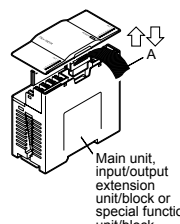

2) Fit the upper edge of the DIN rail mounting groove (right fig. B) onto the DIN rail.
3) Press the product against the DIN rail.

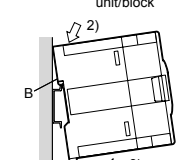

4) Connect the extension cable (right figure A) connected in the procedure 1) to FX3U-1PSU-5V. For details on the extension cable connection, refer to the following manual.
→ **FX3G Series User's Manual - Hardware Edition**
→ **FX3U Series User's Manual - Hardware Edition**

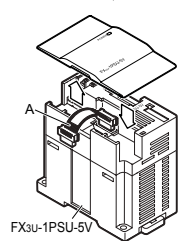

3. Wiring

WIRING PRECAUTIONS **DANGER**

- Connect the AC power supply wiring to the dedicated terminals described in this manual. If an AC power supply is connected to a DC input/output terminal or DC power supply terminal, the PLC will be burnt out.
- Cut off all phases of the power source externally before starting the wiring work, thus avoiding electric shock or damages to the product.
- Ensure the top cover is attached to the product before turning on the power or starting the operation after wiring work. Failure to do so may cause electric shock.

WIRING PRECAUTIONS **CAUTION**

- Perform class D grounding (grounding resistance: 100Ω or less) to the grounding terminal in the main unit and extension units with a 2mm² or thicker wire. Do not connect the grounding terminal at the same point as a heavy electrical system (refer to section 3.3).
- When drilling screw holes or wiring, cutting chips or wire chips should not enter ventilation slits. This may cause fire, failures, or malfunctions.
- Properly perform wiring to the terminal block in accordance with the following precautions. Failure to do so may cause electric shock, equipment failures, a short-circuit, wire breakage, malfunctions, or damage to the product.
 - Termination of the wire should follow the dimensions described in the manual.
 - Tightening torque should be the specifications in the manual.

3.1 Applicable Cable and Terminal Tightening Torque

The size of the terminal screws is M3. The end disposal of the cable shows below. Tighten the terminal to a torque of 0.5N·m to 0.8N·m. Do not tighten terminal screws exceeding the specified torque. Failure to do so may cause equipment failures or malfunctions.

- When one wire is connected to one terminal

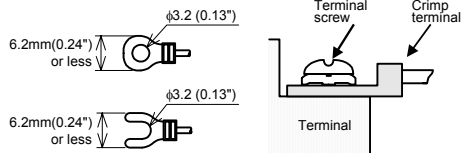

- When two wires are connected to one terminal

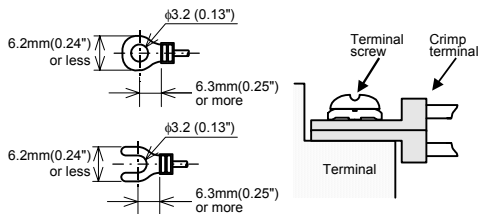

3.2 Power Supply Wiring

For the power supply wiring, refer to the following manual.
 → **FX3G Series User's Manual - Hardware Edition**
 → **FX3U Series User's Manual - Hardware Edition**

Note:

- The FX3U-1PSU-5V power supply should be turned ON simultaneously or before the PLC main unit. Before turning the power OFF, ensure the safety of the system and then simultaneously turn the main unit, FX3U-1PSU-5V, and other extension equipment (the special extension equipment is included) OFF. For details, refer to the following PLC manual
 → **FX3G Series User's Manual - Hardware Edition**
 → **FX3U Series User's Manual - Hardware Edition**

- Grounding and power cables should be positioned to exit the unit from above as shown in the following figure.

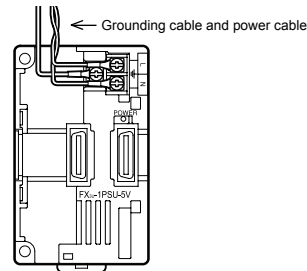

- When connecting an input (only) extension block and an input/output extension block (e.g. FX2N-8ER) to the FX3U-1PSU-5V, supply the power of input circuit for them from the 24V DC service power supply of the nearest preceding main unit or powered extension unit. For details, refer to the following PLC manual.
 → **FX3G Series User's Manual - Hardware Edition**
 → **FX3U Series User's Manual - Hardware Edition**

Power supply wiring

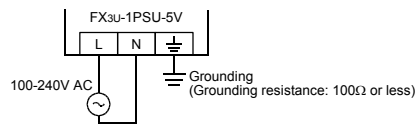

3.3 Grounding

Grounding should be performed as stated below.

- The grounding resistance should be 100Ω or less.
- Independent grounding should be performed for best results. When independent grounding is not performed, perform "shared grounding" of the following figure.

For details, refer to the following manual.
 → **FX3G Series User's Manual - Hardware Edition**
 → **FX3U Series User's Manual - Hardware Edition**

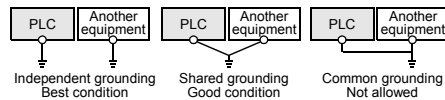

- The grounding wire size should be AWG 14 (2 mm²).
- The grounding point should be close to the PLC, and all grounding wires should be as short as possible.

4. Specification

DESIGN PRECAUTIONS **DANGER**

- Provide a safety circuit on the outside of the PLC so that the whole system operates to ensure the safety even when external power supply trouble or PLC failure occurs. Otherwise, malfunctions or output failures may result in an accident.
 - An emergency stop circuit, a protection circuit, an interlock circuit for opposite movements, such as normal and reverse rotations, and an interlock circuit for preventing damage to the machine at the upper and lower positioning limits should be configured on the outside of the PLC.
 - When the PLC CPU detects an error, such as a watch dog timer error, during self-diagnosis, all outputs are turned off. When an error that cannot be detected by the PLC CPU occurs in an input/output control block, output control may be disabled. Design external circuits and mechanisms to ensure safe operations of the machine in such a case.
 - When some sort of error occurs in a relay, triac or transistor of the output unit/block, output may be kept on or off. For output signals that may lead to serious accidents, design external circuits and mechanisms to ensure safe operations of the machine.

DESIGN PRECAUTIONS **CAUTION**

- Make sure to observe the precautions below in order to prevent any damage to a machine or any wires accident which might be caused by abnormal data written in the PLC due to the influence of noise:
 - Do not lay close or bundle the control line with the main circuit, high-voltage power line, or load line. Otherwise effects of noise or surge induction are likely to take place. Keep a safe distance of more than 100 mm (3.94") from the above when wiring.
 - Ground the shield wire or shield of a shielded cable at one point on the PLC. However, do not ground at the same point as high voltage lines.

STARTUP AND MAINTENANCE PRECAUTIONS **CAUTION**

- Do not disassemble or modify the unit. Doing so may cause failure, malfunction or fire. * For repair, contact your local Mitsubishi Electric distributor.
- Do not drop the product or do not exert strong impact, doing so may cause damage.

DISPOSAL PRECAUTIONS **CAUTION**

- Please contact a company certified in the disposal of electronic waste for environmentally safe recycling and disposal of the product.

TRANSPORT AND STORAGE PRECAUTIONS **CAUTION**

- During transportation, avoid any impact as the product is a precision instrument. Check the operation of the product after transportation.

4.1 Applicable PLC

Model name	Applicability
FX3U Series PLC	Ver. 2.20 or later (from the first product)
FX3G Series PLC	Ver. 1.00 or later (from the first product)

The version number can be checked by monitoring D8001 as the last three digits indicate it.

4.2 General Specifications

The items other than the following are equivalent to those of the PLC main unit. For the general specification, refer to the following manual.
 → **FX3G Series User's Manual - Hardware Edition**
 → **FX3U Series User's Manual - Hardware Edition**

4.3 Power Supply Specifications

Items	Specifications
Supply voltage	100 - 240V AC
Allowable supply voltage range	85 - 264V AC
Rated frequency	50/60Hz
Allowable momentary power failure time	The allowable momentary power failure time depends on the power supply used. <ul style="list-style-type: none"> 100V AC power supply system: The operation is continued to the momentary power failure for 10 or less ms. 200V AC power supply system: The operation is continued to the momentary power failure for 100 or less ms.
In-rush current	30A Max. 5 ms or less/100V AC 65A Max. 5 ms or less/200V AC
Power consumption	20W Max.
Output current (Internal for supply)	24V DC: 0.3A ⁻¹ 5V DC: 1A ⁻¹

*1 **The output current is proportional to the ambient temperature as shown by the derating curve below. FX3U-1PSU-5V should be used in the range of the output current according to this derating curve.**

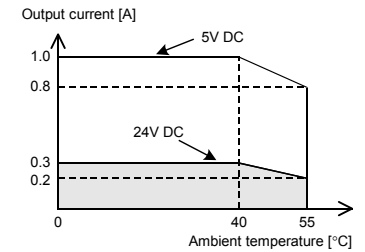

Note for system configuration

For further details on system configuration, refer to the following manual.
 → **FX3G Series User's Manual - Hardware Edition**
 → **FX3U Series User's Manual - Hardware Edition**

- Up to two FX3U-1PSU-5V units may be connected to a FX3U PLC system. Only one FX3U-1PSU-5V unit may be connected to a FX3G PLC system.
- The total of the number of I/O occupied points of the input/output extension block connected to FX3U-1PSU-5V should be the 32 or less points.
- The total of the consumed current of the extension equipment connected to FX3U-1PSU-5V should be the output current capacity or less. However, when connecting an input (only) extension block and an input/output extension block (e.g. FX2N-8ER) to the FX3U-1PSU-5V, supply the power of input circuit for them from the 24V DC service power supply of the nearest preceding main unit or powered extension unit.
- Do not use FX3U-1PSU-5V combining the DC-power-supply type main unit.
- Up to one extension cable (FX0N-65EC, FX0N-30EC) may be connected in one system.

This manual confers no industrial property rights or any rights of any other kind, nor does it confer any patent licenses. Mitsubishi Electric Corporation cannot be held responsible for any problems involving industrial property rights which may occur as a result of using the contents noted in this manual.

Warranty

Mitsubishi will not be held liable for damage caused by factors found not to be the cause of Mitsubishi; opportunity loss or lost profits caused by faults in the Mitsubishi products; damage, secondary damage, accident compensation caused by special factors unpredictable by Mitsubishi; damages to products other than Mitsubishi products; and to other duties.

For safe use

- This product has been manufactured as a general-purpose part for general industries, and has not been designed or manufactured to be incorporated in a device or system used in purposes related to human life.
- Before using the product for special purposes such as nuclear power, electric power, aerospace, medicine or passenger movement vehicles, consult with Mitsubishi Electric.
- This product has been manufactured under strict quality control. However when installing the product where major accidents or losses could occur if the product fails, install appropriate backup or failsafe functions in the system.

MITSUBISHI *Changes for the Better*
 PROGRAMMABLE CONTROLLERS
MELSEC-F
FX3U-1PSU-5V
INSTALLATION MANUAL

Manual Number	JY997D22501
Revision	D
Date	September 2010

This manual describes the part names, dimensions, installation, wiring and specifications of the product. Before use, read this manual and manuals of relevant products fully to acquire proficiency in handling and operating the product. Make sure to learn all the product information, safety information, and precautions.

And, store this manual in a safe place so that you can take it out and read it whenever necessary. Always forward it to the end user.

Registration
 The company name and the product name to be described in this manual are the registered trademarks or trademarks of each company.

Effective September 2010
 Specifications are subject to change without notice.
 © 2006 Mitsubishi Electric Corporation

Safety Precautions (Read these precautions before use.)
 This manual classifies the safety precautions into two categories:
 ⚠ **DANGER** and ⚠ **CAUTION**.

DANGER	Indicates that incorrect handling may cause hazardous conditions, resulting in death or severe injury.
CAUTION	Indicates that incorrect handling may cause hazardous conditions, resulting in medium or slight personal injury or physical damage.

Depending on circumstances, procedures indicated by ⚠ **CAUTION** may also be linked to serious results. Therefore, it is important to follow the directions for usage.

Associated Manuals

Manual name	Manual No.	Description
FX3G Series User's Manual - Hardware Edition	JY997D31301 MODEL CODE: 09R521	Explains FX3G Series PLC specification details for I/O, wiring, installation, and maintenance.
FX3U Series User's Manual - Hardware Edition	JY997D16501 MODEL CODE: 09R516	Explains FX3U Series PLC specification details for I/O, wiring, installation, and maintenance.

How to obtain manuals
 For the necessary product manuals or documents, consult with the Mitsubishi Electric dealer from where you purchase your product.

Certification of UL, cUL standards
 FX3U-1PSU-5V units comply with the UL standards (UL, cUL).

UL, cUL registration number: E95239
 Regarding the standards that comply with the main unit, please refer to either the FX series product catalog or consult with your nearest Mitsubishi product provider.

Compliance with EC directive (CE Marking)
 This note does not guarantee that an entire mechanical module produced in accordance with the contents of this note will comply with the following standards. Compliance to EMC directive and LVD directive for the entire mechanical module should be checked by the user / manufacturer. For more information please consult with your nearest Mitsubishi product provider.
 Regarding the standards that comply with the main unit, please refer to either the FX series product catalog or consult with your nearest Mitsubishi product provider.

Attention

- This product is designed for use in industrial applications.

Note

- Manufactured by: Mitsubishi Electric Corporation
 2-7-3 Marunouchi, Chiyoda-ku, Tokyo, 100-8310 Japan
- Manufactured at: Mitsubishi Electric Corporation Himeji Works
 840 Chiyoda-machi, Himeji, Hyogo, 670-8677 Japan
- Authorized Representative in the European Community:
 Mitsubishi Electric Europe B.V.
 Gothaer Str. 8, 40880 Ratingen, German

Requirement for Compliance with EMC directive
 The following products have shown compliance through direct testing (of the identified standards below) and design analysis (through the creation of a technical construction file) to the European Directive for Electromagnetic Compatibility (2004/108/EC) when used as directed by the appropriate documentation.

Type: Programmable Controller (Open Type Equipment)
Models: MELSEC FX3U series manufactured from February 1st, 2006 FX3U-1PSU-5V

Standard	Remark
EN61131-2:2007 Programmable controllers - Equipment requirements and tests	Compliance with all relevant aspects of the standard. EMI • Radiated Emissions • Conducted Emissions EMS • Radiated electromagnetic field • Fast transient burst • Electrostatic discharge • High-energy surge • Voltage drops and interruptions • Conducted RF • Power frequency magnetic field

Requirement for Compliance with LVD directive
 The following products have shown compliance through direct testing (of the identified standards below) and design analysis (through the creation of a technical construction file) to the European Directive for Low Voltage (2006/95/EC) when used as directed by the appropriate documentation.

Type: Programmable Controller (Open Type Equipment)
Models: MELSEC FX3U series manufactured from February 1st, 2006 FX3U-1PSU-5V

Standard	Remark
EN61131-2:2007 Programmable controllers - Equipment requirements and tests	The equipment has been assessed as a component for fitting in a suitable enclosure which meets the requirements of EN61131-2:2007

1. Introduction
 When the FX3G, FX3U internal power supplied from the FX3G, FX3U PLC (AC power supply type) is insufficient for powering the output extension blocks or special function blocks, the FX3U-1PSU-5V (extension power supply unit) is available. Up to two FX3U-1PSU-5V units may be connected to a FX3U PLC system. Only one FX3U-1PSU-5V unit may be connected to a FX3G PLC system. Connect extension equipment to the FX3U-1PSU-5V according to the configuration specification limits described in the following manuals.
 For details on installation and wiring, and system configuration with the FX3G and FX3U Series PLC including the FX3U-1PSU-5V, refer to the following manuals.
 → FX3G Series User's Manual - Hardware Edition
 → FX3U Series User's Manual - Hardware Edition

1.1 Incorporated Items
 Check that the following product and items are included in the package:

Product	Item
FX3U-1PSU-5V extension power supply unit	
Accessories	Dust proof protection sheet Extension cable Installation manual (This manual)

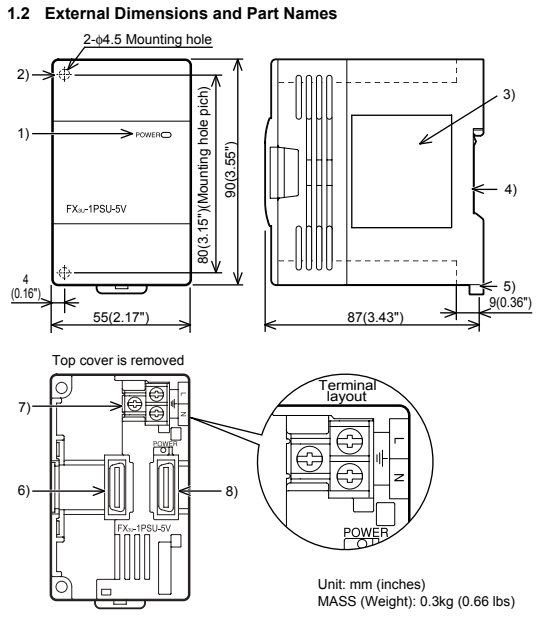

- POWER LED (green)
- Direct mounting hole: 2 holes of φ4.5 (0.18") (mounting screw: M4 screw)
- Name plate
- DIN rail mounting groove (DIN rail: DIN46277)
- DIN rail mounting hook
- Extension connector for preceding unit/block
- Power supply terminal block
- Extension connector for next unit/block

2. Installation

INSTALLATION PRECAUTIONS ⚠ **DANGER**

- Cut off all phases of the power source externally before starting the installation work, thus avoiding electric shock or damages to the product.

INSTALLATION PRECAUTIONS ⚠ **CAUTION**

- Use the product in the environment within the general specifications described in the PLC main unit manual (Hardware Edition). Never use the product in areas with dust, oily smoke, conductive dusts, corrosive gas (salt air, Cl₂, H₂S, SO₂, or NO₂), flammable gas, vibrations or impacts, or expose it to high temperature, condensation, or wind and rain. If the product is used in such a place described above, electrical shock, fire, malfunction, damage, or deterioration may be caused.
- Do not touch the conductive parts of the product directly, in order to avoid electrical shock, failure or malfunction.
- Install the product securely using the DIN rail or screws.
- Install the product on a flat surface. If the mounting surface is rough, undue force will be applied to the PC board, thereby causing nonconformity.
- When drilling screw holes or wiring, cutting chips or wire chips should not enter ventilation slits. This may cause fire, failures, or malfunctions.
- Be sure to remove the dust proof sheet from the PLC's ventilation port when the installation work is completed. Failure to do so could cause fires, equipment failures, and malfunctions.
- Fit the extension cables and communication cables securely to the designated connectors. Contact failures may cause malfunctions.

2.1 Arrangements
 The product connects on the right side of a PLC main unit, input/output extension unit/block or special function unit/block.
 For further information of installation arrangements, refer to the following manual.
 → FX3G Series User's Manual - Hardware Edition
 → FX3U Series User's Manual - Hardware Edition

2.2 Mounting
 The product is mounted by the following method.

- Direct mounting
- DIN rail mounting

2.2.1 Direct Mounting
 The product can be mounted with M4 screws by using the direct mounting holes. Refer to the External Dimensions (section 1.2) for the product's mounting hole pitch information.
 An internal space between each unit of 1 to 2 mm (0.04" to 0.08") is necessary. For further information on direct installation, also refer to the following manual.
 → FX3G Series User's Manual - Hardware Edition
 → FX3U Series User's Manual - Hardware Edition

2.2.2 DIN Rail Mounting
 The product can be mounted on a DIN rail (DIN46227, 35mm width).

- Connect the extension cable (right fig. A) to the main unit, input/output extension unit/block and special function unit/block on the left.
 For details on the extension cable connection, refer to the following manual.
 → FX3G Series User's Manual - Hardware Edition
 → FX3U Series User's Manual - Hardware Edition

- Fit the upper edge of the DIN rail mounting groove (right fig. B) onto the DIN rail.
- Press the product against the DIN rail.

- Connect the extension cable (right figure A) connected in the procedure 1) to FX3U-1PSU-5V.
 For details on the extension cable connection, refer to the following manual.
 → FX3G Series User's Manual - Hardware Edition
 → FX3U Series User's Manual - Hardware Edition

- Connect the extension cable (right figure A) connected in the procedure 1) to FX3U-1PSU-5V.
 For details on the extension cable connection, refer to the following manual.
 → FX3G Series User's Manual - Hardware Edition
 → FX3U Series User's Manual - Hardware Edition

3. Wiring

WIRING PRECAUTIONS ⚠ **DANGER**

- Connect the AC power supply wiring to the dedicated terminals described in this manual. If an AC power supply is connected to a DC input/output terminal or DC power supply terminal, the PLC will be burnt out.
- Cut off all phases of the power source externally before starting the wiring work, thus avoiding electric shock or damages to the product.
- Ensure the top cover is attached to the product before turning on the power or starting the operation after wiring work. Failure to do so may cause electric shock.

WIRING PRECAUTIONS ⚠ **CAUTION**

- Perform class D grounding (grounding resistance: 100Ω or less) to the grounding terminal in the main unit and extension units with a 2mm² or thicker wire. Do not connect the grounding terminal at the same point as a heavy electrical system (refer to section 3.3).
- When drilling screw holes or wiring, cutting chips or wire chips should not enter ventilation slits. This may cause fire, failures, or malfunctions.
- Properly perform wiring to the terminal block in accordance with the following precautions. Failure to do so may cause electric shock, equipment failures, a short-circuit, wire breakage, malfunctions, or damage to the product.
 - Termination of the wire should follow the dimensions described in the manual.
 - Tightening torque should be the specifications in the manual.

3.1 Applicable Cable and Terminal Tightening Torque

The size of the terminal screws is M3. The end disposal of the cable shows below. Tighten the terminal to a torque of 0.5N•m to 0.8N•m. Do not tighten terminal screws exceeding the specified torque. Failure to do so may cause equipment failures or malfunctions.

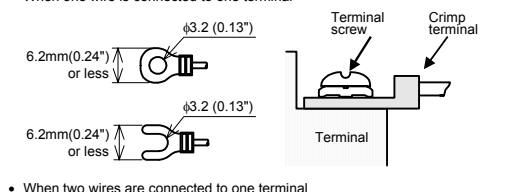

3.2 Power Supply Wiring

For the power supply wiring, refer to the following manual.
 → FX3G Series User's Manual - Hardware Edition
 → FX3U Series User's Manual - Hardware Edition

- Note:**
- The FX3U-1PSU-5V power supply should be turned ON simultaneously or before the PLC main unit. Before turning the power OFF, ensure the safety of the system and then simultaneously turn the main unit, FX3U-1PSU-5V, and other extension equipment (the special extension equipment is included) OFF.
 For details, refer to the following PLC manual
 → FX3G Series User's Manual - Hardware Edition
 → FX3U Series User's Manual - Hardware Edition

- Grounding and power cables should be positioned to exit the unit from above as shown in the following figure.

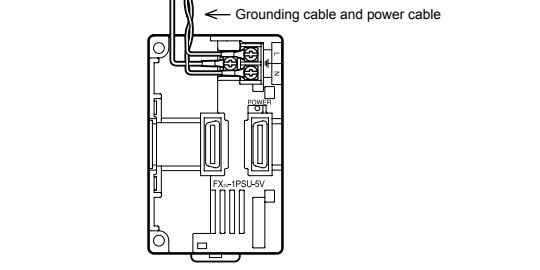

- When connecting an input (only) extension block and an input/output extension block (e.g. FX2N-8ER) to the FX3U-1PSU-5V, supply the power of input circuit for them from the 24V DC service power supply of the nearest preceding main unit or powered extension unit.
 For details, refer to the following PLC manual.
 → FX3G Series User's Manual - Hardware Edition
 → FX3U Series User's Manual - Hardware Edition

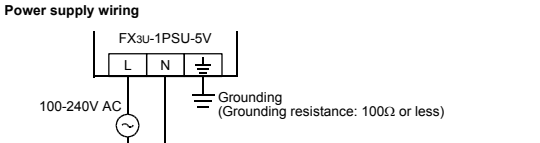

3.3 Grounding

- Grounding should be performed as stated below.
- The grounding resistance should be 100Ω or less.
 - Independent grounding should be performed for best results. When independent grounding is not performed, perform "shared grounding" of the following figure. For details, refer to the following manual.
 → FX3G Series User's Manual - Hardware Edition
 → FX3U Series User's Manual - Hardware Edition

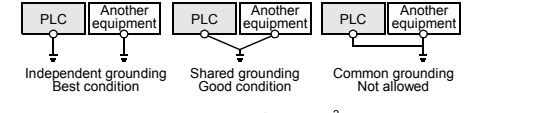

- The grounding wire size should be AWG 14 (2 mm²).
- The grounding point should be close to the PLC, and all grounding wire should be as short as possible.

4. Specification

DESIGN PRECAUTIONS ⚠ **DANGER**

- Provide a safety circuit on the outside of the PLC so that the whole system operates to ensure the safety even when external power supply trouble or PLC failure occurs. Otherwise, malfunctions or output failures may result in an accident.
 - An emergency stop circuit, a protection circuit, an interlock circuit for opposite movements, such as normal and reverse rotations, and an interlock circuit for preventing damage to the machine at the upper and lower positioning limits should be configured on the outside of the PLC.
 - When the PLC CPU detects an error, such as a watch dog timer error, during self-diagnosis, all outputs are turned off. When an error that cannot be detected by the PLC CPU occurs in an input/output control block, output control may be disabled. Design external circuits and mechanisms to ensure safe operations of the machine in such a case.
 - When some sort of error occurs in a relay, triac or transistor of the output unit/block, output may be kept on or off. For output signals that may lead to serious accidents, design external circuits and mechanisms to ensure safe operations of the machine.

DESIGN PRECAUTIONS ⚠ **CAUTION**

- Make sure to observe the precautions below in order to prevent any damage to a machine or any wires accident which might be caused by abnormal data written in the PLC due to the influence of noise:
 - Do not lay close or bundle the control line with the main circuit, high-voltage power line, or load line. Otherwise effects of noise or surge induction are likely to take place. Keep a safe distance of more than 100 mm (3.94") from the above when wiring.
 - Ground the shield wire or shield of a shielded cable at one point on the PLC. However, do not ground at the same point as high voltage lines.

STARTUP AND MAINTENANCE PRECAUTIONS ⚠ **CAUTION**

- Do not disassemble or modify the unit. Doing so may cause failure, malfunction or fire. * For repair, contact your local Mitsubishi Electric distributor.
- Do not drop the product or do not exert strong impact, doing so may cause damage.

DISPOSAL PRECAUTIONS ⚠ **CAUTION**

- Please contact a company certified in the disposal of electronic waste for environmentally safe recycling and disposal of the product.

TRANSPORT AND STORAGE PRECAUTIONS ⚠ **CAUTION**

- During transportation, avoid any impact as the product is a precision instrument. Check the operation of the product after transportation.

4.1 Applicable PLC

Model name	Applicability
FX3U Series PLC	Ver. 2.20 or later (from the first product)
FX3G Series PLC	Ver. 1.00 or later (from the first product)

The version number can be checked by monitoring D8001 as the last three digits indicate it.

4.2 General Specifications

The items other than the following are equivalent to those of the PLC main unit. For the general specification, refer to the following manual.
 → FX3G Series User's Manual - Hardware Edition
 → FX3U Series User's Manual - Hardware Edition

4.3 Power Supply Specifications

Items	Specifications
Supply voltage	100 - 240V AC
Allowable supply voltage range	85 - 264V AC
Rated frequency	50/60Hz
Allowable momentary power failure time	The allowable momentary power failure time depends on the power supply used. <ul style="list-style-type: none"> 100V AC power supply system: The operation is continued to the momentary power failure for 10 or less ms. 200V AC power supply system: The operation is continued to the momentary power failure for 100 or less ms.
In-rush current	30A Max. 5 ms or less/100V AC 65A Max. 5 ms or less/200V AC
Power consumption	20W Max.
Output current (Internal for supply)	24V DC: 0.3A ⁻¹ 5V DC: 1A ⁻¹

*1 The output current is proportional to the ambient temperature as shown by the derating curve below. FX3U-1PSU-5V should be used in the range of the output current according to this derating curve.

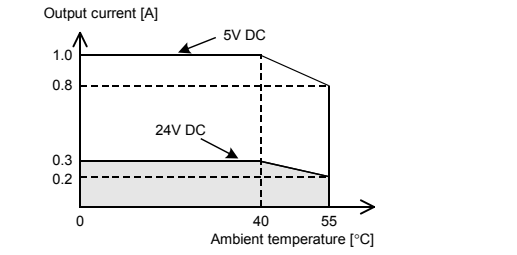

Note for system configuration
 For further details on system configuration, refer to the following manual.
 → FX3G Series User's Manual - Hardware Edition
 → FX3U Series User's Manual - Hardware Edition

- Up to two FX3U-1PSU-5V units may be connected to a FX3U PLC system. Only one FX3U-1PSU-5V unit may be connected to a FX3G PLC system.
- The total of the number of I/O occupied points of the input/output extension block connected to FX3U-1PSU-5V should be the 32 or less points.
- The total of the consumed current of the extension equipment connected to FX3U-1PSU-5V should be the output current capacity or less. However, when connecting an input (only) extension block and an input/output extension block (e.g. FX2N-8ER) to the FX3U-1PSU-5V, supply the power of input circuit for them from the 24V DC service power supply of the nearest preceding main unit or powered extension unit.
- Do not use FX3U-1PSU-5V combining the DC-power-supply type main unit.
- Up to one extension cable (FX0N-65EC, FX0N-30EC) may be connected in one system.

This manual confers no industrial property rights or any rights of any other kind, nor does it confer any patent licenses. Mitsubishi Electric Corporation cannot be held responsible for any problems involving industrial property rights which may occur as a result of using the contents noted in this manual.

Warranty
 Mitsubishi will not be held liable for damage caused by factors found not to be the cause of Mitsubishi; opportunity loss or lost profits caused by faults in the Mitsubishi products; damage, secondary damage, accident compensation caused by special factors unpredictable by Mitsubishi; damages to products other than Mitsubishi products; and to other duties.

For safe use

- This product has been manufactured as a general-purpose part for general industries, and has not been designed or manufactured to be incorporated in a device or system used in purposes related to human life.
- Before using the product for special purposes such as nuclear power, electric power, aerospace, medicine or passenger movement vehicles, consult with Mitsubishi Electric.
- This product has been manufactured under strict quality control. However when installing the product where major accidents or losses could occur if the product fails, install appropriate backup or failsafe functions in the system.