

Industrial automation

Elincom Group

 European Union: www.elinco.eu

 Russia: www.elinc.ru

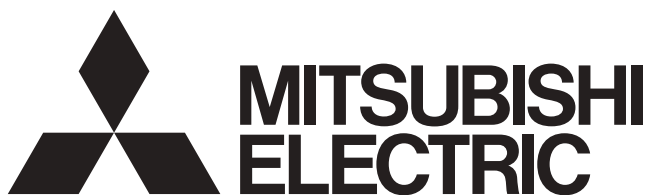

PROGRAMMABLE CONTROLLERS



MELSEC iQ-F
series



MELSEC iQ-F
FX5 User's Manual (Startup)

SAFETY PRECAUTIONS

(Read these precautions before use.)

Before using this product, please read this manual and the relevant manuals introduced in this manual carefully and pay full attention to safety in order to handle the product correctly.

This manual classifies the safety precautions into two categories: [ WARNING] and [ CAUTION].

 WARNING	Indicates that incorrect handling may cause hazardous conditions, resulting in death or severe injury.
 CAUTION	Indicates that incorrect handling may cause hazardous conditions, resulting in minor or moderate injury or property damage.

Depending on the circumstances, procedures indicated by [ CAUTION] may also cause severe injury.

It is important to follow all precautions for personal safety.

Store this manual in a safe place so that it can be read whenever necessary. Always forward it to the end user.

[DESIGN PRECAUTIONS]

WARNING

- Make sure to set up the following safety circuits outside the PLC to ensure safe system operation even during external power supply problems or PLC failure. Otherwise, malfunctions may cause serious accidents.
 - Most importantly, set up the following: an emergency stop circuit, a protection circuit, an interlock circuit for opposite movements (such as normal vs. reverse rotation), and an interlock circuit (to prevent damage to the equipment at the upper and lower positioning limits).
 - Note that when the CPU module detects an error, such as a watchdog timer error, during self-diagnosis, all outputs are turned off. Also, when an error that cannot be detected by the CPU module occurs in an input/output control block, output control may be disabled. External circuits and mechanisms should be designed to ensure safe machinery operation in such a case.
 - Note that the output current of the 24 V DC service power supply varies depending on the model and the absence/presence of extension modules. If an overload occurs, the voltage automatically drops, inputs in the PLC are disabled, and all outputs are turned off. External circuits and mechanisms should be designed to ensure safe machinery operation in such a case.
 - Note that when an error occurs in a relay, transistor or triac of an output circuit, the output might stay on or off. For output signals that may lead to serious accidents, external circuits and mechanisms should be designed to ensure safe machinery operation in such a case.
 - Construct an interlock circuit in the program so that the whole system always operates on the safe side before executing the control (for data change) of the PLC in operation.

Read the manual thoroughly and ensure complete safety before executing other controls (for program change, parameter change, forcible output and operation status change) of the PLC in operation. Otherwise, the machine may be damaged and accidents may occur due to erroneous operations.
 - In an output circuit, when a load current exceeding the current rating or an overcurrent caused by a load short-circuit flows for a long time, it may cause smoke and fire. To prevent this, configure an external safety circuit, such as a fuse.
 - For the operating status of each station after a communication failure of the network, refer to relevant manuals for the network. Incorrect output or malfunction may result in an accident.
 - To maintain the safety of the programmable controller system against unauthorized access from external devices via the network, take appropriate measures. To maintain the safety against unauthorized access via the Internet, take measures such as installing a firewall.
-

[DESIGN PRECAUTIONS]

CAUTION

- When an inductive load such as a lamp, heater, or solenoid valve is controlled, a large current (approximately ten times greater than normal) may flow when the output is turned from off to on. Take proper measures so that the flowing current does not exceed the value corresponding to the maximum load specification of the resistance load.
 - After the CPU module is powered on or is reset, the time taken to enter the RUN status varies depending on the system configuration, parameter settings, and/or program size.
Design circuits so that the entire system will always operate safely, regardless of this variation in time.
 - Simultaneously turn on and off the power supplies of the CPU module and extension modules.
 - If a long-time power failure or an abnormal voltage drop occurs, the PLC stops, and output is turned off. When the power supply is restored, it will automatically restart (when the RUN/STOP/RESET switch is on the RUN side).
-

[INSTALLATION PRECAUTIONS]

WARNING

- Make sure to cut off all phases of the power supply externally before attempting installation or wiring work. Failure to do so may cause electric shock or damage to the product.
 - Use the product within the generic environment specifications described in the User's Manual (Hardware) of the CPU module used.
Never use the product in areas with excessive dust, oily smoke, conductive dusts, corrosive gas (salt air, Cl₂, H₂S, SO₂ or NO₂), flammable gas, vibration or impacts, or expose it to high temperature, condensation, or rain and wind.
If the product is used in such conditions, electric shock, fire, malfunctions, deterioration or damage may occur.
-

[INSTALLATION PRECAUTIONS]

CAUTION

- Do not touch the conductive parts of the product directly. Doing so may cause device failures or malfunctions.
 - When drilling screw holes or wiring, make sure that cutting and wiring debris do not enter the ventilation slits of the PLC. Failure to do so may cause fire, equipment failures or malfunctions.
 - For the product supplied together with a dust proof sheet, the sheet should be affixed to the ventilation slits before the installation and wiring work to prevent foreign objects such as cutting and wiring debris.
However, when the installation work is completed, make sure to remove the sheet to provide adequate ventilation. Failure to do so may cause fire, equipment failures or malfunctions.
 - Install the product on a flat surface. If the mounting surface is rough, undue force will be applied to the PC board, thereby causing nonconformities.
 - Install the product securely using a DIN rail or mounting screws.
 - Connect the expansion board and expansion adapter securely to their designated connectors. Loose connections may cause malfunctions.
 - Make sure to affix the expansion board with tapping screws. Tightening torque should follow the specifications in the manual. If the screws are tightened outside of the specified torque range, poor connections may cause malfunctions.
-

CAUTION

- Work carefully when using a screwdriver such as installation of the product. Failure to do so may cause damage to the product or accidents.
 - Connect the extension cables, peripheral device cables, input/output cables and battery connecting cable securely to their designated connectors. Loose connections may cause malfunctions.
 - When using an SD memory card, insert it into the SD memory card slot. Check that it is inserted completely. Poor contact may cause malfunction.
 - Turn off the power to the PLC before attaching or detaching the following devices. Failure to do so may cause equipment failures or malfunctions.
 - Peripheral devices, expansion board, expansion adapter, and connector conversion adapter
 - Extension modules, bus conversion module, and connector conversion module
 - Battery
-

[WIRING PRECAUTIONS]

WARNING

- Make sure to cut off all phases of the power supply externally before attempting installation or wiring work. Failure to do so may cause electric shock or damage to the product.
 - Make sure to attach the terminal cover, provided as an accessory, before turning on the power or initiating operation after installation or wiring work. Failure to do so may cause electric shock.
 - The temperature rating of the cable should be 80°C or more.
 - Make sure to wire the screw terminal block in accordance with the following precautions. Failure to do so may cause electric shock, equipment failures, a short-circuit, wire breakage, malfunctions, or damage to the product.
 - The disposal size of the cable end should follow the dimensions described in the User's Manual (Hardware) of the CPU module used.
 - Tightening torque should follow the specifications in the User's Manual (Hardware) of the CPU module used.
 - Tighten the screws using a Phillips-head screwdriver No. 2 (shaft diameter 6 mm or less). Make sure that the screwdriver does not touch the partition part of the terminal block.
 - Make sure to properly wire to the terminal block (European type) in accordance with the following precautions. Failure to do so may cause electric shock, equipment failures, a short-circuit, wire breakage, malfunctions, or damage to the product.
 - The disposal size of the cable end should follow the dimensions described in the User's Manual (Hardware) of the CPU module used.
 - Tightening torque should follow the specifications in the User's Manual (Hardware) of the CPU module used.
 - Twist the ends of strand wire and make sure that there are no loose wires.
 - Do not solder-plate the electric wire ends.
 - Do not connect more than the specified number of wires or electric wires of unspecified size.
 - Affix the electric wires so that neither the terminal block nor the connected parts are directly stressed.
-

[WIRING PRECAUTIONS]

CAUTION

- Do not supply power to the [24+] and [24V] terminals (24 V DC service power supply) on the CPU module or extension modules. Doing so may cause damage to the product.
 - Perform class D grounding (grounding resistance: 100 Ω or less) of the grounding terminal on the CPU module and extension modules with a wire 2 mm² or thicker.
Do not use common grounding with heavy electrical systems (refer to the User's Manual (Hardware) of the CPU module used).
 - Connect the power supply to the dedicated terminals specified in the User's Manual (Hardware) of the CPU module used. If an AC power supply is connected to a DC input/output terminal or DC power supply terminal, the PLC will burn out.
 - Do not wire vacant terminals externally. Doing so may damage the product.
 - Install module so that excessive force will not be applied to terminal blocks, power connectors, I/O connectors, communication connectors, or communication cables. Failure to do so may result in wire damage/breakage or PLC failure.
 - Make sure to observe the following precautions in order to prevent any damage to the machinery or accidents due to malfunction of the PLC caused by abnormal data written to the PLC due to the effects of noise.
 - Do not bundle the power line, control line and communication cables together with or lay them close to the main circuit, high-voltage line, load line or power line. As a guideline, lay the power line, control line and communication cables at least 100 mm away from the main circuit, high-voltage line, load line or power line.
 - Ground the shield of the shield wire or shielded cable at one point on the PLC. However, do not use common grounding with heavy electrical systems.
 - Ground the shield of the analog input/output cable at one point on the signal receiving side. However, do not use common grounding with heavy electrical systems.
-

[STARTUP AND MAINTENANCE PRECAUTIONS]

WARNING

- Do not touch any terminal while the PLC's power is on. Doing so may cause electric shock or malfunctions.
 - Before cleaning or retightening terminals, cut off all phases of the power supply externally. Failure to do so in the power ON status may cause electric shock.
 - Before modifying the program in operation, forcible output, running or stopping the PLC, read through this manual carefully, and ensure complete safety. An operation error may damage the machinery or cause accidents.
 - Do not change the program in the PLC from two or more peripheral equipment devices at the same time. (i.e. from an engineering tool and a GOT) Doing so may cause destruction or malfunction of the PLC program.
-

WARNING

- Use the battery for memory backup in conformance to the User's Manual (Hardware) of the CPU module used.
 - Use the battery for the specified purpose only.
 - Connect the battery correctly.
 - Do not charge, disassemble, heat, put in fire, short-circuit, connect reversely, weld, swallow or burn the battery, or apply excessive forces (vibration, impact, drop, etc.) to the battery.
 - Do not store or use the battery at high temperatures or expose to direct sunlight.
 - Do not expose to water, bring near fire or touch liquid leakage or other contents directly.
- Incorrect handling of the battery may cause heat excessive generation, bursting, ignition, liquid leakage or deformation, and lead to injury, fire or failures and malfunction of facilities and other equipment.
-

[STARTUP AND MAINTENANCE PRECAUTIONS]

CAUTION

- Do not disassemble or modify the PLC. Doing so may cause fire, equipment failures, or malfunctions. For repair, contact your local Mitsubishi Electric representative.
 - After the first use of the SD memory card, do not insert/remove the memory card more than 500 times. 500 times or more may cause malfunction.
 - Turn off the power to the PLC before connecting or disconnecting any extension cable. Failure to do so may cause equipment failures or malfunctions.
 - Turn off the power to the PLC before attaching or detaching the following devices. Failure to do so may cause equipment failures or malfunctions.
 - Peripheral devices, expansion board, expansion adapter, and connector conversion adapter
 - Extension modules, bus conversion module, and connector conversion module
 - Battery
-

[OPERATION PRECAUTIONS]

CAUTION

- Construct an interlock circuit in the program so that the whole system always operates on the safe side before executing the control (for data change) of the PLC in operation. Read the manual thoroughly and ensure complete safety before executing other controls (for program change, parameter change, forcible output and operation status change) of the PLC in operation. Otherwise, the machine may be damaged and accidents may occur by erroneous operations.
-

[DISPOSAL PRECAUTIONS]

CAUTION

- Please contact a certified electronic waste disposal company for the environmentally safe recycling and disposal of your device.
 - When disposing of batteries, separate them from other waste according to local regulations. (For details of the Battery Directive in EU countries, refer to the User's Manual (Hardware) of the CPU module used.)
-

[TRANSPORTATION PRECAUTIONS]

CAUTION

- When transporting the PLC with the optional battery, turn on the PLC before shipment, confirm that the battery mode is set using a parameter and the BAT LED is OFF, and check the battery life. If the PLC is transported with the BAT LED ON or the battery exhausted, the battery-backed data may be unstable during transportation.
 - The PLC is a precision instrument. During transportation, avoid impacts larger than those specified in the general specifications of the User's Manual (Hardware) of the CPU module by using dedicated packaging boxes and shock-absorbing palettes. Failure to do so may cause failures in the PLC. After transportation, verify operation of the PLC and check for damage of the mounting part, etc.
 - When transporting lithium batteries, follow required transportation regulations. (For details on the regulated products, refer to the User's Manual (Hardware) of the CPU module used.)
 - When fumigants that contain halogen materials such as fluorine, chlorine, bromine, and iodine are used for disinfecting and protecting wooden packaging from insects, they cause malfunction when entering our products. Please take necessary precautions to ensure that remaining materials from fumigant do not enter our products, or treat packaging with methods other than fumigation (heat method). Additionally, disinfect and protect wood from insects before packing products.
-

INTRODUCTION

This manual contains text, diagrams and explanations which will guide the reader in the correct installation, safe use and operation of the FX5 Programmable Controllers and should be read and understood before attempting to install or use the module.

Always forward it to the end user.

Regarding use of this product

- This product has been manufactured as a general-purpose part for general industries, and has not been designed or manufactured to be incorporated in a device or system used in purposes related to human life.
- Before using the product for special purposes such as nuclear power, electric power, aerospace, medicine or passenger movement vehicles, consult Mitsubishi Electric.
- This product has been manufactured under strict quality control. However when installing the product where major accidents or losses could occur if the product fails, install appropriate backup or failsafe functions in the system.

Note

- If in doubt at any stage during the installation of the product, always consult a professional electrical engineer who is qualified and trained in the local and national standards. If in doubt about the operation or use, please consult the nearest Mitsubishi Electric representative.
- Since the examples indicated by this manual, technical bulletin, catalog, etc. are used as a reference, please use it after confirming the function and safety of the equipment and system. Mitsubishi Electric will accept no responsibility for actual use of the product based on these illustrative examples.
- This manual content, specification etc. may be changed without a notice for improvement.
- The information in this manual has been carefully checked and is believed to be accurate; however, if you notice a doubtful point, an error, etc., please contact the nearest Mitsubishi Electric representative. When doing so, please provide the manual number given at the end of this manual.

CONTENTS

SAFETY PRECAUTIONS	1
INTRODUCTION	7
RELEVANT MANUALS	10
TERMS	11
CHAPTER 1 PART NAMES	13
1.1 FX5U CPU module	13
Front panel	13
Side	15
1.2 Part Names	16
Front panel	16
Side	17
CHAPTER 2 SPECIFICATIONS	18
2.1 Performance Specifications	18
CHAPTER 3 FUNCTION LIST	20
CHAPTER 4 PROCEDURES BEFORE OPERATION	22
4.1 Installing a Battery	23
FX5U CPU module	23
FX5UC CPU module	24
4.2 Inserting and Removing an SD Memory card	25
4.3 Creating a Project	26
4.4 Connecting a Personal Computer	27
4.5 Initializing the CPU Module	28
4.6 Setting Parameters	28
4.7 Programming	30
Registering labels	30
Inserting program elements	31
Inserting program elements by key input	33
4.8 Converting the Program	34
4.9 Saving the Project	34
4.10 Writing Data to the CPU Module	34
4.11 Resetting the CPU Module	35
4.12 Executing the Program	35
4.13 Monitoring the Program	36
4.14 Troubleshooting	37
Troubleshooting procedure	37
Checking with LEDs	38
Troubleshooting using the engineering tool	39
Module diagnostics (CPU Diagnostics)	39
Appendix	40
Appendix 1 External Dimensions, Accessories	40
FX5U CPU module	40
FX5UC CPU module	41
Appendix 2 Functions of FX5U CPU module	42

INDEX

43

REVISIONS46
WARRANTY47
TRADEMARKS48

RELEVANT MANUALS

Manual name <manual number>	Description
MELSEC iQ-F FX5 User's Manual (Startup) <JY997D58201> (This manual)	Performance specifications, procedures before operation, and troubleshooting of the CPU module.
MELSEC iQ-F FX5U User's Manual (Hardware) <JY997D55301>	Describes the details of hardware of the FX5U CPU module, including input/output specifications, wiring, installation, and maintenance.
MELSEC iQ-F FX5UC User's Manual (Hardware) <JY997D61401>	Describes the details of hardware of the FX5UC CPU module, including input/output specifications, wiring, installation, and maintenance.
MELSEC iQ-F FX5 User's Manual (Application) <JY997D55401>	Describes basic knowledge required for program design, functions of the CPU module, devices/labels, and parameters.
MELSEC iQ-F FX5 Programming Manual (Program Design) <JY997D55701>	Describes specifications of ladders, ST, FBD/LD, and other programs and labels.
MELSEC iQ-F FX5 Programming Manual (Instructions, Standard Functions/Function Blocks) <JY997D55801>	Describes specifications of instructions and functions that can be used in programs.
MELSEC iQ-F FX5 User's Manual (Serial Communication) <JY997D55901>	Describes N:N network, MELSEC Communication protocol, inverter communication, non-protocol communication, and predefined protocol support.
MELSEC iQ-F FX5 User's Manual (MELSEC Communication Protocol) <JY997D60801>	Explains methods for the device that is communicating with the CPU module by MC protocol to read and write the data of the CPU module.
MELSEC iQ-F FX5 User's Manual (MODBUS Communication) <JY997D56101>	Describes MODBUS serial communication.
MELSEC iQ-F FX5 User's Manual (Ethernet Communication) <JY997D56201>	Describes the functions of the built-in Ethernet port communication function.
MELSEC iQ-F FX5 User's Manual (SLMP) <JY997D56001>	Explains methods for the device that is communicating with the CPU module by SLMP to read and write the data of the CPU module.
MELSEC iQ-F FX5 User's Manual (CC-Link IE) <JY997D64201>	Describes the functions of the CC-Link IE field network.
MELSEC iQ-F FX5 User's Manual (Positioning Control) <JY997D56301>	Describes the positioning function.
MELSEC iQ-F FX5 User's Manual (Analog Control) <JY997D60501>	Describes the analog function.
GX Works3 Operating Manual <SH-081215ENG>	System configuration, parameter settings, and online operations of GX Works3.

TERMS

Unless otherwise specified, this manual uses the following terms.

- □ indicates a variable part to collectively call multiple models or versions.

(Example) FX5U-32MR/ES, FX5U-32MT/ES ⇒ FX5U-32M□/ES

- For details on the FX3 devices that can be connected with the FX5, refer to the User's Manual (Hardware) of the CPU module to be used.

Terms	Description
■Devices	
FX5	Generic term for FX5U and FX5UC PLCs
FX3	Generic term for FX3S, FX3G, FX3GC, FX3U, and FX3UC PLCs
FX5 CPU module	Generic term for FX5U CPU module and FX5UC CPU module
FX5U CPU module	Generic term for FX5U-32MR/ES, FX5U-32MT/ES, FX5U-32MT/ESS, FX5U-64MR/ES, FX5U-64MT/ES, FX5U-64MT/ESS, FX5U-80MR/ES, FX5U-80MT/ES, FX5U-80MT/ESS, FX5U-32MR/DS, FX5U-32MT/DS, and FX5U-32MT/DSS
FX5UC CPU module	Generic term for FX5UC-32MT/D, FX5UC-32MT/DSS, FX5UC-64MT/D, FX5UC-64MT/DSS, FX5UC-96MT/D, and FX5UC-96MT/DSS
Extension module	Generic term for FX5 extension modules and FX3 function modules
• FX5 extension module	Generic term for I/O modules, FX5 extension power supply module, and FX5 intelligent function module
• FX3 extension module	Generic term for FX3 extension power supply module and FX3 intelligent function module
Extension module (extension cable type)	Generic term for Input modules (extension cable type), Output modules (extension cable type), Powered input/output module, High-speed pulse input/output module, Extension power supply module (extension cable type), Connector conversion module (extension cable type), Intelligent function modules, and Bus conversion module (extension cable type)
Extension module (extension connector type)	Generic term for Input modules (extension connector type), Output modules (extension connector type), Input/output modules, Extension power supply module (extension connector type), Connector conversion module (extension connector type), and Bus conversion module (extension connector type)
I/O module	Generic term for input modules, output modules, Input/output modules, powered input/output modules, and high-speed pulse input/output modules
Input module	Generic term for Input modules (extension cable type) and Input modules (extension connector type)
• Input module (extension cable type)	Generic term for FX5-8EX/ES and FX5-16EX/ES
• Input module (extension connector type)	Generic term for FX5-C16EX/D, FX5-C16EX/DS, FX5-C32EX/D, and FX5-C32EX/DS
Output module	Generic term for output modules (extension cable type) and output modules (extension connector type)
• Output module (extension cable type)	Generic term for FX5-8EYR/ES, FX5-8EYT/ES, FX5-8EYT/ESS, FX5-16EYR/ES, FX5-16EYT/ES, and FX5-16EYT/ESS
• Output module (extension connector type)	Generic term for FX5-C16EYT/D, FX5-C16EYT/DSS, FX5-C32EYT/D, and FX5-C32EYT/DSS
Input/output module	Generic term for FX5-C32ET/D and FX5-C32ET/DSS
Powered input/output module	Generic term for FX5-32ER/ES, FX5-32ET/ES, FX5-32ET/ESS, FX5-32ER/DS, FX5-32ET/DS, and FX5-32ET/DSS
High-speed pulse input/output module	Generic term for FX5-16ET/ES-H and FX5-16ET/ESS-H
Extension power supply module	Generic term for FX5 extension power supply module (extension cable type), FX5 extension power supply module (extension connector type), and FX3 extension power supply module
• FX5 extension power supply module (extension cable type)	Different name for FX5-1PSU-5V
• FX5 extension power supply module (extension connector type)	Different name for FX5-C1PS-5V
• FX3 extension power supply module	Different name for FX3U-1PSU-5V
Intelligent module	The abbreviation for intelligent function modules
Intelligent function module	Generic term for FX5 intelligent function modules and FX3 intelligent function modules
• FX5 intelligent function module	Generic term for FX5-40SSC-S and FX5-CCLIEF
• FX3 intelligent function module	Generic term for FX3U-4AD, FX3U-4DA, FX3U-4LC, FX3U-1PG, FX3U-2HC, FX3U-16CCL-M, FX3U-64CCL, and FX3U-128ASL-M
Expansion board	Generic term for board for FX5U CPU module
• Communication board	Generic term for FX5-232-BD, FX5-485-BD, and FX5-422-BD-GOT
Expansion adapter	Generic term for adapter for FX5 CPU module
• Communication adapter	Generic term for FX5-232ADP and FX5-485ADP
• Analog adapter	Generic term for FX5-4AD-ADP and FX5-4DA-ADP

Terms	Description
Bus conversion module	Generic term for Bus conversion module (extension cable type) and Bus conversion module (extension connector type)
• Bus conversion module (extension cable type)	Different name for FX5-CNV-BUS
• Bus conversion module (extension connector type)	Different name for FX5-CNV-BUSC
Connector conversion module	Generic term for Connector conversion module (extension cable type) and Connector conversion module (extension connector type)
• Connector conversion module (extension cable type)	Different name for FX5-CNV-IF
• Connector conversion module (extension connector type)	Different name for FX5-CNV-IFC
Extension cable	Generic term for FX5-30EC and FX5-65EC
Connector conversion adapter	Different name for FX5-CNV-BC
Battery	Different name for FX3U-32BL
SD memory card	Generic term for NZ1MEM-2GBSD, NZ1MEM-4GBSD, L1MEM-2GBSD and L1MEM-4GBSD SD memory cards Abbreviation of Secure Digital Memory Card. Device that stores data using flash memory.
Peripheral device	Generic term for engineering tools and GOTs
GOT	Generic term for Mitsubishi Graphic Operation Terminal GOT1000 and GOT2000 series
■Software packages	
Engineering tool	The product name of the software package for the MELSEC programmable controllers
GX Works3	The product name of the software package, SWnDND-GXW3, for the MELSEC programmable controllers (The 'n' represents a version.)
■Program relation	
FB instance	A function block that is inserted to a program
Global label	A label that is valid for all the program data when multiple program data are created in the project. There are two types of global label: a module specific label (module label), which is generated automatically by the engineering tool, and an optional label, which can be created for any specified device.
Device	A device (X, Y, M, D, or others) in a CPU module
POU	A unit that configures a program. Units are categorized and provided in accordance with functions. Use of POUs enables dividing the lower-layer processing in a hierarchical program into some units in accordance with processing or functions, and creating programs for each unit.
Program block	A group of POUs that configure a program
Module label	A label that represents one of memory areas (buffer memory areas) specific to each module in a given character string. For the module used, the engineering tool automatically generates this label, which can be used as a global label.
Label	A label that represents a device in a given character string

1 PART NAMES

This section describes the part names of the CPU module.

1.1 FX5U CPU module

Front panel

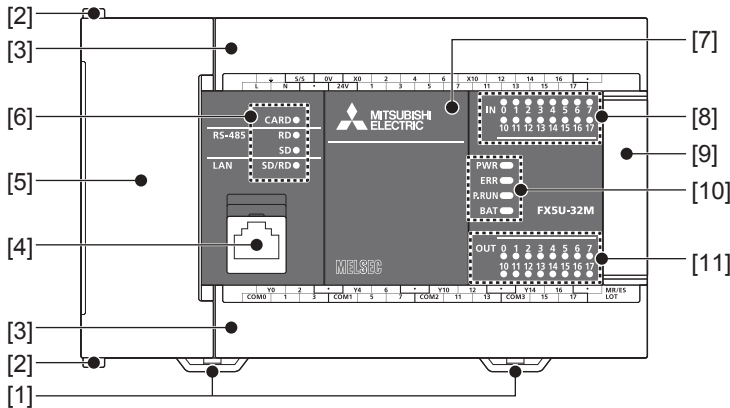

No.	Name	Description
[1]	DIN rail mounting hooks	Hook for mounting the CPU module on a DIN rail of DIN46277 (35 mm wide).
[2]	Expansion adapter connecting hooks	When connecting an expansion adapter, secure it with these hooks.
[3]	Terminal block cover	Cover for protecting the terminal block. The cover can be opened for wiring. Keep the covers closed while equipment is running (power is on).
[4]	Built-in Ethernet communication connector	Connector for connection with Ethernet-compatible devices. (with cap) For details, refer to MELSEC iQ-F FX5 User's Manual (Ethernet Communication).
[5]	Top cover	Cover for protecting the SD memory card slot, the RUN/STOP/RESET switch, and others. The built-in RS-485 communication terminal block, built-in analog I/O terminal block, RUN/STOP/RESET switch, SD memory card slot, and others are located under this cover.
[6]	CARD LED	Indicates whether an SD memory card can be used or not. Lit: Can be used or cannot be removed. Flashing: In preparation Off: Not inserted or can be removed.
	RD LED	Lit when the CPU module is receiving data through built-in RS-485 communication.
	SD LED	Lit when the CPU module is sending data through built-in RS-485 communication.
	SD/RD LED	Lit when the CPU module is sending or receiving data through built-in Ethernet communication.
[7]	Expansion board connector cover	Cover for protecting expansion board connector, battery, or others. Connect the battery under this cover.
[8]	Input display LED	Lit when input is on.
[9]	Extension connector cover	Cover for protecting the extension connector. Connect the extension cable of an extension module to the extension connector under the cover.
[10]	PWR LED	Indicates whether the CPU module is powered or not. Lit: Powered Off: Not powered or hardware error
	ERR LED	Indicates the error status of the CPU module. Lit: Error or hardware error Flashing: Factory default setting, error, hardware error, or resetting Off: Operating normally
	P.RUN LED	Indicates the program running status. Lit: Operating normally Flashing: Paused Off: Stopped or stop error
	BAT LED	Indicates the battery status. Flashing: Battery error Off: Operating normally

No.	Name	Description
[11]	Output display LED	Lit when output is on.

With cover open

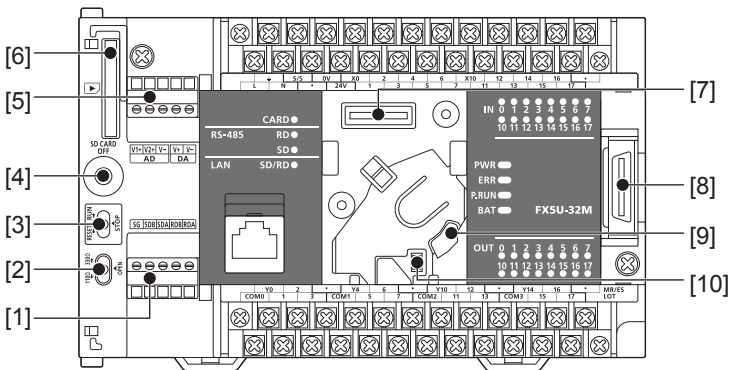

No.	Name	Description
[1]	Built-in RS-485 communication terminal block	Terminal block for connection with RS-485-compatible devices For details, refer to MELSEC iQ-F FX5U User's Manual (Hardware).
[2]	RS-485 terminal resistor selector switch	Switch for switching terminal resistance for built-in RS-485 communication.
[3]	RUN/STOP/RESET switch	Switch for operating the CPU module. RUN: Runs the program STOP: Stops the program RESET: Resets the CPU module (hold the switch on the RESET side for approximately 1 second.)
[4]	SD memory card disable switch	Switch for disabling access to the SD memory card when the card is to be removed.
[5]	Built-in analog I/O terminal block	Terminal block for using the built-in analog function. For details, refer to MELSEC iQ-F FX5U User's Manual (Hardware).
[6]	SD memory card slot	Slot for inserting an SD memory card.
[7]	Expansion board connector	Connector for connecting an expansion board.
[8]	Extension connector	Connector for connecting the extension cable of an extension module.
[9]	Battery holder	Holder for storing an optional battery.
[10]	Battery connector	Connector for connecting an optional battery.

Point

Use a tool such as a screwdriver to operate RS-485 terminal resistor selector switch.
Make sure that the edge of the tool does not damage the switch or the case.

When the terminal block covers are open

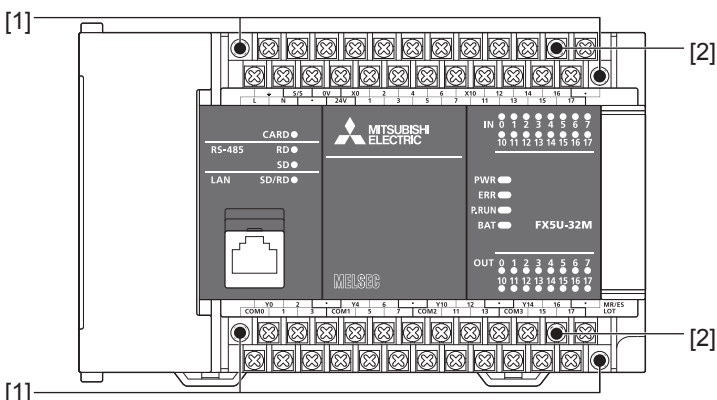

No.	Name	Description
[1]	Terminal block mounting screws	Gradually loosen the left and right screws (alternately), and remove the top of the terminal blocks.
[2]	Terminal	Terminals for power, input, and output. For details on the terminal layout, refer to MELSEC iQ-F FX5U User's Manual (Hardware).

Side

Left side/Right side

Left side

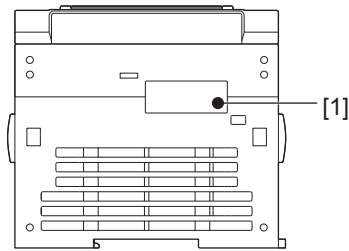

Right side

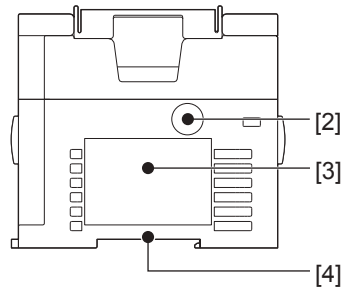

No.	Name	Description
[1]	Expansion adapter connector cover	Cover for protecting the expansion adapter connector. Connect the expansion adapter to the expansion adapter connector under the cover.
[2]	Genuine product certification label	Genuine product certification label to prevent counterfeiting
[3]	Nameplate	The product model name, Manufacturer's serial number, power supply specifications and MAC address are shown.
[4]	DIN rail mounting groove	The module can be installed on DIN46277 rail (35 mm wide).

Point

Products that do not have the genuine product certification label or nameplate and the nameplate are not covered by the warranty.

Top side/Bottom side

Top side

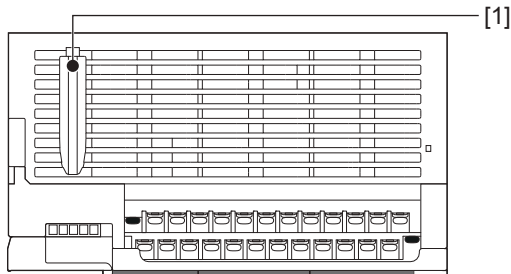

Bottom side



No.	Name	Description
[1]	CPU module fixing screw hole	Screw holes for fixing the CPU module to the panel. (In the case of FX5U-64M□/80M□, there are four screw holes.)

1.2 Part Names

Front panel

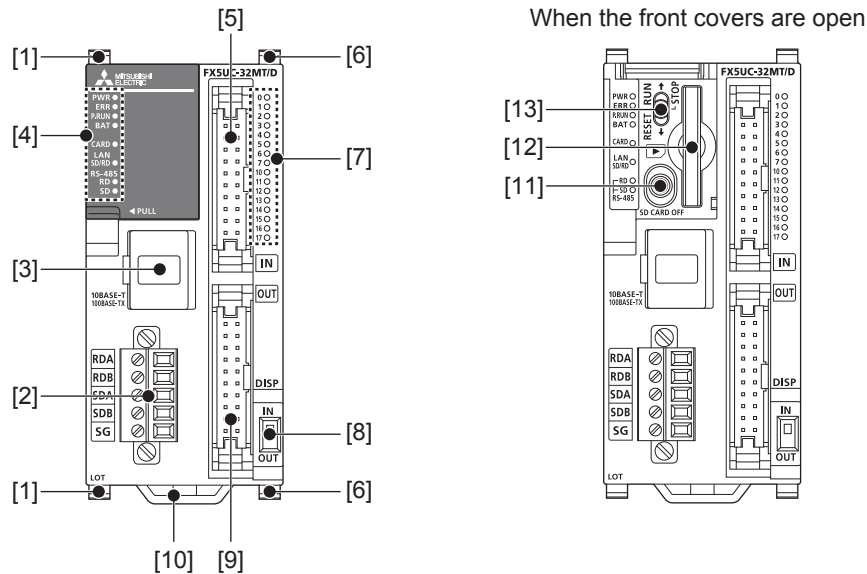

No.	Name	Description
[1]	Expansion adapter connecting hooks	When connecting an expansion adapter, secure it with these hooks.
[2]	Built-in RS-485 communication terminal block	Terminal block for connection with RS-485-compatible devices
[3]	Built-in Ethernet communication connector	Connector for connection with Ethernet-compatible devices (with cap) For details, refer to MELSEC iQ-F FX5 User's Manual (Ethernet Communication).
[4]	Operation status display LED	
	PWR LED	Indicates whether the CPU module is powered or not. Lit: Powered Off: Not powered or hardware error
	ERR LED	Indicates the error status of the CPU module. Lit: Error or hardware error Flashing: Factory default setting, error, hardware error, or resetting Off: Operating normally
	P.RUN LED	Indicates the program running status. Lit: Operating normally Flashing: Paused Off: Stopped or stop error
	BAT LED	Indicates the battery status. Flashing: Battery error Off: Operating normally
	CARD LED	Indicates whether an SD memory card can be used or not. Lit: Can be used or cannot be removed. Flashing: In preparation Off: Not inserted or can be removed.
	SD/RD LED	Lit when the CPU module is sending or receiving data through built-in Ethernet communication.
	RD LED	Lit when the CPU module is receiving data through built-in RS-485 communication.
	SD LED	Lit when the CPU module is sending data through built-in RS-485 communication.
[5]	Input connector	Connector for connecting input signal cables.
[6]	Extension module connecting hook	When connecting an expansion module, secure it with these hooks.
[7]	I/O display LED	Lit when the input or output is on.
[8]	DISP switch	Switches input/output of the I/O display LED.
[9]	Output connector	Connector for connecting output signal cables.
[10]	DIN rail mounting hook	Hook for mounting a CPU module on a DIN rail of DIN46277 (35 mm wide).
[11]	SD memory card disable switch	Switch for disabling access to the SD memory card when the card is to be removed.

No.	Name	Description
[12]	SD memory card slot	Slot for inserting an SD memory card.
[13]	RUN/STOP/RESET switch	Switch for operating the CPU module. RUN: Runs the program STOP: Stops the program RESET: Resets the CPU module (hold the switch on the RESET side for approximately 1 second.)

Side

Left side/right side

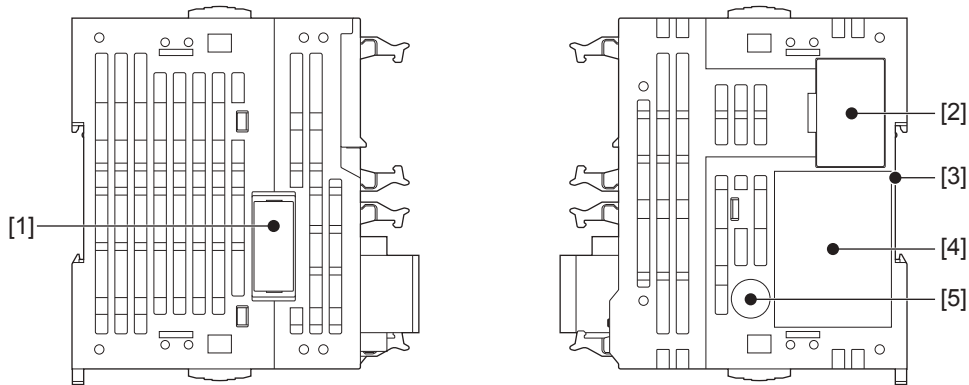

No.	Name	Description
[1]	Expansion adapter connector cover	Cover for protecting the expansion adapter connector.
[2]	Subsequent extension connector cover	Cover for protecting the subsequent extension connector.
[3]	DIN rail mounting groove	The module can be installed on a DIN46277 rail (35 mm wide).
[4]	Nameplate	The product model name, manufacturer's serial number, power supply specifications, and MAC address are shown.
[5]	Genuine product certification label	Genuine product certification label to prevent counterfeiting

Point

Products that do not have the genuine product certification label or nameplate are not covered by the warranty.

Bottom side

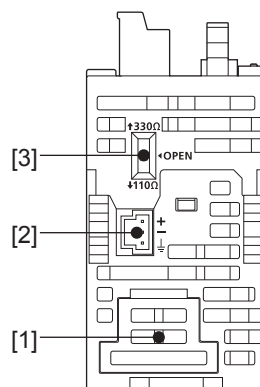

No.	Name	Description
[1]	Battery cover	Cover for protecting the battery connecting connector.
[2]	Power connector for CPU module	Connector for connecting power cables.
[3]	RS-485 terminal resistor selector switch	Switch for switching terminal resistance for built-in RS-485 communication.

Point

Use a tool such as a screwdriver to operate the RS-485 terminal resistance selector switch. Make sure that the tip of a tool does not damage the switch or case.

2 SPECIFICATIONS

The CPU module performance specifications are explained below. For details on the other specifications, refer to the following manual.

📖 MELSEC iQ-F FX5U User's Manual (Hardware)

📖 MELSEC iQ-F FX5UC User's Manual (Hardware)

2.1 Performance Specifications

Item	Specification	
Control system	Stored-program repetitive operation	
Input/output control system	Refresh system (Direct access input/output allowed by specification of direct access input/output [DX, DY])	
Programming specifications	Programming language	Ladder diagram (LD), structured text (ST), function block diagram/ladder diagram (FBD/LD)
	Programming extension function	Function block (FB), function (FUN), label programming (local/global)
	Constant scan	0.2 to 2000 ms (can be set in 0.1 ms increments)
	Fixed cycle interrupt	1 to 60000 ms (can be set in 1 ms increments)
	Timer performance specifications	100 ms, 10 ms, 1 ms
	No. of program executions	32
	No. of FB files	16 (Up to 15 for user)
Operation specifications	Execution type	Standby type, initial execution type, scan execution type, event execution type
	Interrupt type	Internal timer interrupt, input interruption, high-speed comparison match interrupt
Command processing time	LD X0	34 ns
	MOV D0 D1	34 ns
Memory capacity	Program capacity	64 k steps (128 kbytes, flash memory)
	SD memory card	Memory card capacity (SD/SDHC memory card: Max. 4 Gbytes)
	Device/label memory	120 kbytes
	Data memory/standard ROM	5 Mbytes
Flash memory (Flash ROM) write count	Maximum 20000 times	
File storage capacity	Device/label memory	1
	Data memory P: No. of program files FB: No. of FB files	P: 32, FB: 16
	SD memory card	📖 MELSEC iQ-F FX5U User's Manual (Hardware) 📖 MELSEC iQ-F FX5UC User's Manual (Hardware)
Clock function	Display data	Year, month, day, hour, minute, second, day of week (leap year automatic detection)
	Precision	-2.96 to +3.74 (TYP.+1.42) s/d (Ambient temperature: 0°C (32°F)) -3.18 to +3.74 (TYP.+1.50) s/d (Ambient temperature: 25°C (77°F)) -13.20 to +2.12 (TYP.-3.54) s/d (Ambient temperature: 55°C (131°F))
No. of input/output points	(1) No. of input/output points	256 points or less
	(2) No. of remote I/O points	384 points or less
	Total No. of points of (1) and (2)	512 points or less
Power failure retention ^{*1}	Retention method	Large-capacity capacitor
	Retention time	10 days (Ambient temperature: 25°C (77°F))
	Data retained	Clock data

*1 Clock data is retained using the power accumulated in a large-capacity capacitor incorporated into the PLC. When voltage of the large-capacity capacitor drops, clock data is no longer accurately retained. The retention period of a fully charged capacitor (electricity is conducted across the PLC for at least 30 minutes) is 10 days (ambient temperature: 25°C (77°F)). How long the capacitor can hold the data depends on the operating ambient temperature. When the operating ambient temperature is high, the holding period is short.

Number of device points

Item		Base	Max. number of points	
No. of user device points	Input relay (X)	8	1024 points	
	Output relay (Y)	8	1024 points	
	Internal relay (M)	10	32768 points (can be changed with parameter) ^{*1}	
	Latch relay (L)	10	32768 points (can be changed with parameter) ^{*1}	
	Link relay (B)	16	32768 points (can be changed with parameter) ^{*1}	
	Annunciator (F)	10	32768 points (can be changed with parameter) ^{*1}	
	Link special relay (SB)	16	32768 points (can be changed with parameter) ^{*1}	
	Step relay (S)	10	4096 points (fixed)	
	Timer system	Timer (T)	10	1024 points (can be changed with parameter) ^{*1}
	Accumulation timer system	Accumulation timer (ST)	10	1024 points (can be changed with parameter) ^{*1}
	Counter system	Counter (C)	10	1024 points (can be changed with parameter) ^{*1}
		Long counter (LC)	10	1024 points (can be changed with parameter) ^{*1}
	Data register (D)		10	8000 points (can be changed with parameter) ^{*1}
	Link register (W)		16	32768 points (can be changed with parameter) ^{*1}
	Link special register (SW)		16	32768 points (can be changed with parameter) ^{*1}
No. of system device points	Special relay (SM)	10	10000 points (fixed)	
	Special register (SD)	10	12000 points (fixed)	
Module access device	Intelligent function module device	10	65536 points (designated by U□\G□)	
No. of index register points	Index register (Z) ^{*2}	10	24 points	
	Long index register (LZ) ^{*2}	10	12 points	
No. of file register points	File register (R)	10	32768 points (can be changed with parameter) ^{*1}	
No. of nesting points	Nesting (N)	10	15 points (fixed)	
No. of pointer points	Pointer (P)	10	4096 points	
	Interrupt pointer (I)	10	178 points (fixed)	
Others	Decimal constant (K)	Signed	—	16 bits: -32768 to +32767, 32 bits: -2147483648 to +2147483647
		Unsigned	—	16 bits: 0 to 65535, 32 bits: 0 to 4294967295
	Hexadecimal constant (H)	—	16 bits: 0 to FFFF, 32 bits: 0 to FFFFFFFF	
	Real constant (E)	Single precision	—	E-3.40282347+38 to E-1.17549435-38, 0, E1.17549435-38 to E3.40282347+38
	Character string		—	Shift-JIS code max. 255 single-byte characters (256 including NULL)

*1 Can be changed with parameters within the capacity range of the CPU built-in memory.

*2 Total of the index register (Z) and long index register (LZ) is maximum 24 words.

3 FUNCTION LIST

The following table lists the functions of the CPU module.

Function		Description
Scan monitoring function (Watchdog timer setting)		Detects an error in the hardware and program of the CPU module by monitoring the scan time.
Clock function		This function is used for the time management in the function which the system operates such as the date of the error history.
Online change	Changing ladder blocks while online	Writes the part of a program edited on the ladder editor using the engineering tool to the CPU module in units of ladder blocks. Edited contents spanning multiple files or multiple portions can be written to the CPU module at once.
Interrupt function	Multiple interrupt function	When an interrupt occurs while an interrupt program triggered by another cause is running, stops the program if its priority is lower than that of the new interrupt, and runs the higher-priority program whenever its execution condition is satisfied.
PID control function		Performs PID control by the PID control instruction.
Constant scan		Keeps the scan time constant and executes program repeatedly.
Remote operation	Remote RUN/STOP	Changes the CPU module status to the RUN/STOP/PAUSE status externally while the RUN/STOP/RESET switch of the CPU module is in RUN status.
	Remote PAUSE	
	Remote RESET	Resets the CPU module externally while the CPU module is in the STOP status.
Device/label memory area setting		Sets the capacity of each area in the device/label memory
Device initial value setting		Sets the initial value of the device at the program execution without programs.
Latch function		Holds the contents of the device and label of the CPU module when the power is turned ON etc.
Memory card function	SD memory card forced stop	Makes the SD memory card unavailable without turning OFF the power even when the function accessing the SD memory card is executed.
	Boot operation	Transfers the file stored in the SD memory card to the transfer destination memory judged automatically by the CPU module when the power is turned ON or is reset.
Device/label access service processing setting		Sets the frequency of execution of the device/label access service process that is carried out by the END process in the parameter.
RAS function	Self-diagnostics function	Self-diagnoses the CPU module to see whether an error exist or not.
	Error clear	Batch-clears all the continuation errors being detected.
Security function		Protects resources stored in PCs and resources in the units in the system of the FX5 from illegal access by a third party such as theft, alteration, accidental operation and unauthorized execution.
High-speed input/output function	High-speed counter function	Performs high-speed counter, pulse width measurement, input interruption etc. by using the input of the CPU module or high-speed pulse input/output module.
	Pulse width measurement function	
	Input interrupt function	
	Positioning function	Executes positioning operation by using the transistor output of the CPU module or high-speed pulse input/output module.
Built-in analog function*1	PWM output function	Executes a PWM output by using the transistor output of the CPU module or high-speed pulse input/output module.
	Analog input function	Two analog inputs and one analog output are built in the FX5U CPU module so that voltage input/voltage output can be performed.
Analog output function		
Built-in Ethernet function		A function related to the Ethernet such as the connection with the MELSOFT products and GOTs, and socket communication.
Serial communication function		A function related to the serial communication such as inverter communication function and non-protocol communication.
MODBUS RTU communication function		Connection with the products which support MODBUS RTU is available. The master and slave functions can be used.

*1 Only the FX5U CPU module supports the functions.

4 PROCEDURES BEFORE OPERATION

This chapter describes the procedures before operation.

1. Installing a battery

Install a battery to the CPU module as needed. ( Page 23 Installing a Battery)

2. Inserting an SD memory card

Insert an SD memory card to the CPU module as needed. ( Page 25 Inserting and Removing an SD Memory card)

3. Wiring of each device

Wire each device.

 MELSEC iQ-F FX5U User's Manual (Hardware)

 MELSEC iQ-F FX5UC User's Manual (Hardware)

4. Connecting a personal computer

Connect the CPU module to a personal computer that has an engineering tool installed. ( Page 27 Connecting a Personal Computer)

5. Powering on the system

Check the following items, and then power on the system.

- A cable is correctly connected to the power supply.
- Power supply voltage is within the specified range.
- The CPU module is in the STOP state.

6. Initializing the CPU module

Initialize the CPU module using the engineering tool. ( Page 28 Initializing the CPU Module)

7. Setting parameters

Set system parameters, CPU parameters, and module parameters. ( Page 28 Setting Parameters)

When the following function of the CPU module are used, parameters of the function must be set.

- When the built-in Ethernet function is used
- When a function that uses SD memory card is used
- When any intelligent function module is mounted

8. Programming

Create a program using the engineering tool. ( Page 30 Programming)

9. Writing data to the programmable controller

Write the parameters and the program created by using the engineering tool to the programmable controller. ( Page 34 Writing Data to the CPU Module)

10. Resetting the CPU module

Restart the system in either of the following ways.

- Power off and on the system.
- Reset the CPU module. ( Page 35 Resetting the CPU Module)

11. Executing the program

Run the CPU module, and check that the P.RUN LED turns on. ( Page 35 Executing the Program)

12. Monitoring the program

Check that the program operates normally using the engineering tool. ( Page 36 Monitoring the Program)

4.1 Installing a Battery

Install a battery to the CPU module as needed.

FX5U CPU module

Installation procedure

The battery is not included with the CPU module during shipment from the factory. To use the battery, attach it following the procedure below. Parameter setting is required to back up the device memory and clock data using the battery. (MELSEC iQ-F FX5U User's Manual (Hardware))

1. Turn the power supply off.
2. Remove the expansion board connector cover (A in figure below). If an expansion board is installed, remove it.

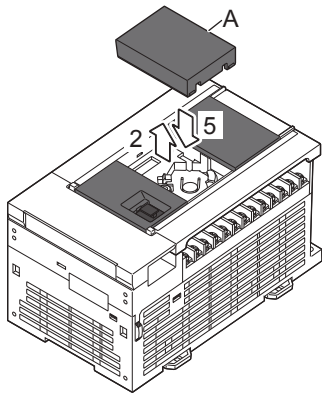

3. Insert the battery connector (B in the figure below) of the battery.
4. Set the battery inside the lower hook (C in the following figure), push up the upper hook (D in the following figure), and then fit the battery in the battery holder (E in the following figure). The following figure shows the position of the battery.

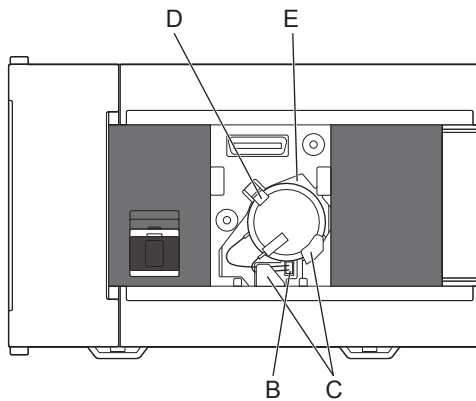

5. Attach the expansion board connector cover. If an expansion board was removed in step 2, reinstall it.

FX5UC CPU module

Attachment procedure

The battery is not incorporated in the CPU module at shipment from the factory. To use the battery, attach it following the procedure below. Proper parameter setting is required to back up the device memory and clock data using the battery.

( MELSEC iQ-F FX5UC User's Manual (Hardware))

1. Turn the power supply off.
2. Remove the battery cover (A in the figure below).

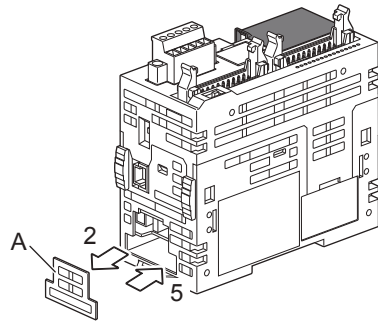

3. Push the battery into the battery holder (B in the figure below).
4. Insert the battery connector (C in the figure below) of the battery.

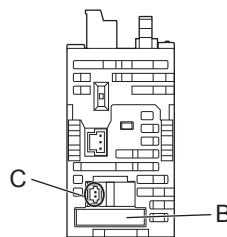

5. Attach the battery cover.

4.2 Inserting and Removing an SD Memory card

The following explains insertion and removal of the SD memory card.

Insertion procedure

Mount the SD memory card. Pay attention to the direction of the card and follow the procedure below.

■FX5U CPU module

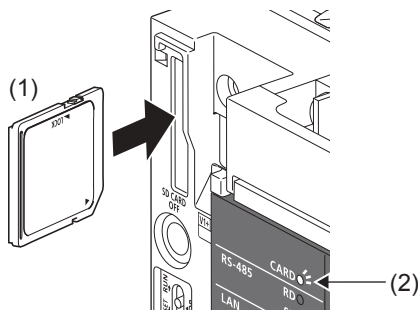

1. Insert the SD memory card (1) straight into the SD memory card slot. Make sure that the notch of the card is directed downward. After mounting, check that the card is mounted completely. If the card is mounted incompletely, malfunction may occur due to poor contact.
2. The CARD LED (2) blinks until the SD memory card becomes available.
3. The CARD LED turns on when the SD memory card is available.
4. If the CARD LED does not turn on even though the SD memory card is mounted, make sure that SM606 (memory card disable request) and SM607 (memory card disable status flag) are OFF by using engineering tools.

■FX5UC CPU module

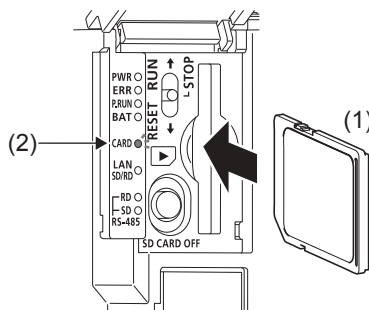

Removal procedure

■FX5U CPU module

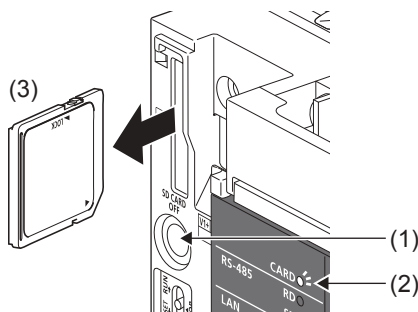

1. Press the SD memory card stop switch (1) for one second or more to stop access to the card. The CARD READY LED (2) blinks during the access stop operation, and then the LED is turned OFF when the operation is completed.
2. Insert the SD memory card (3) once, and then pull it straight out.

■FX5UC CPU module

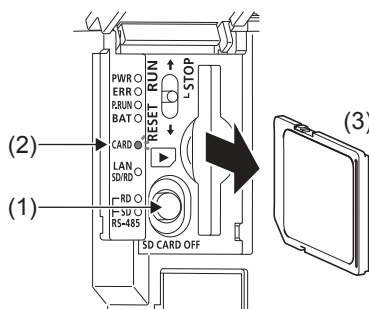

Precautions

- When mounting or removing the SD memory card while the power is ON, follow the above-mentioned procedure. Otherwise, the data in the card may become corrupted.
- When removing an SD memory card which is being accessed by a function, the CARD LED is turned OFF after the access is completed. When the CARD LED is turned OFF depends on the accessing function.
- When SM605 (memory card interchange protect flag) is ON, the CARD LED is not turned OFF even if the SD memory card stop switch is pressed. If the CARD LED is not turned OFF, turn ON SM606 (memory card disable request) so that the SD memory card cannot be used.

4.3 Creating a Project

Activate the engineering tool and create a project.

 [Project] ⇒ [New]

Procedure

Create a program, following the procedure below. This procedure is for programs described in ladder diagram.

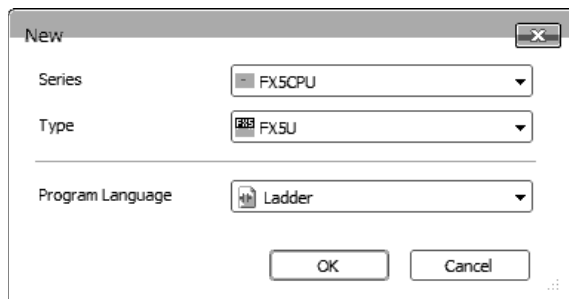

1. Select the model of the CPU module used. Then, specify a programming language used for the project. Select "Ladder", and click the [OK] button.

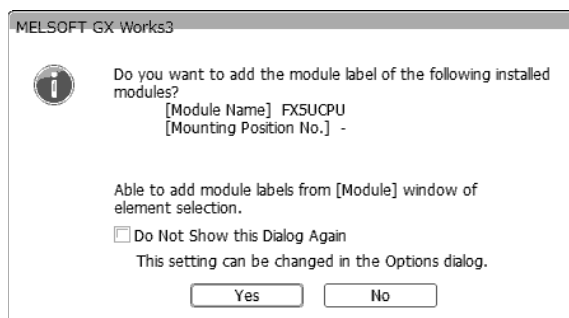

2. Click the [Yes] button when the window for adding module labels of the CPU module appears.

Point

Module label is a label where the I/O signals and buffer memory areas of a module have already been defined. Use of module labels allows programming without being aware of module internal addresses.

4.4 Connecting a Personal Computer

Connect the CPU module to a personal computer that has an engineering tool installed.

For details on the system configuration examples and GX Works3 settings, refer to the following manual.

📖 MELSEC iQ-F FX5U User's Manual (Hardware)

📖 MELSEC iQ-F FX5UC User's Manual (Hardware)

Procedure

Connect a personal computer directly to the CPU module, following the procedure below.

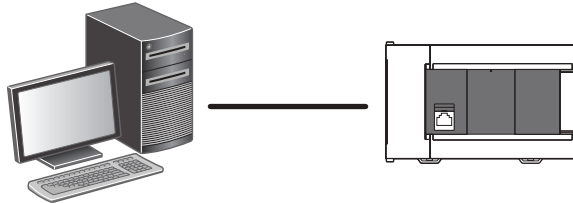

1. Connect a personal computer to the CPU module using a RS-232C cable^{*1} or Ethernet cable.
2. Select [Online] ⇒ [Specify Connection Destination] on the menu bar of the engineering tool.
3. Click the [CPU Module Direct Coupled Setting] button (1) on the "Specify Connection Destination Connection" window.
4. Select the connection method, and click the [Yes] button.
5. Click the [Connection Test] button (2), and check if the personal computer is connected to the CPU module.

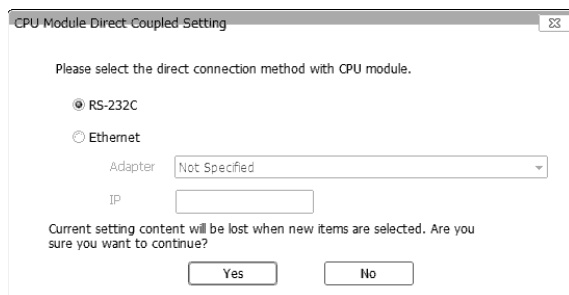
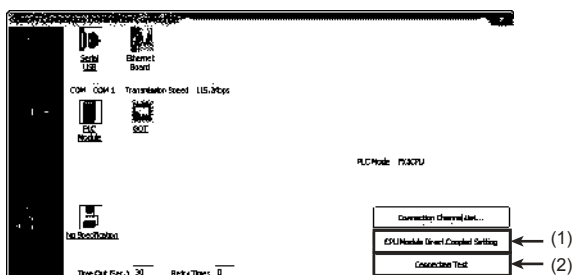

*1 When connecting by a RS-232C cable, an expansion board or expansion adapter is required.

Point

For the FX5 CPU module, the Ethernet adapter on the personal computer side used for the Ethernet port direct connection can be specified. Select the adapter on the "CPU Module Direct Coupled Setting" window.

4.5 Initializing the CPU Module

Initialize the CPU module.

 [Online] ⇒ [CPU Memory Operation]

Procedure

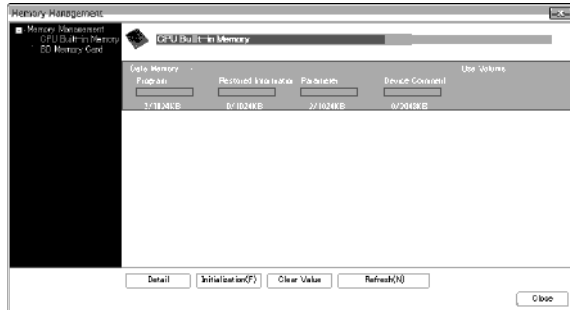

1. Select "Data Memory" on the "Memory Management" window, and click the [Initialization] button.
2. After the initialization processing completes, click the [Close] button.

4.6 Setting Parameters

Set system parameters and parameters for each module.

When setting parameters from the Navigation window

The following shows how to set parameters.

■System parameters

These parameters need to be set from the Navigation window in the following cases: to change the Model Name, and to set CPU Module Operation Setting at Error Detection.

 "Navigation window" ⇒ "Parameter" ⇒ "System Parameter"

■CPU Parameter

CPU module requires setting of CPU Parameter.

 "Navigation window" ⇒ "Parameter" ⇒ "FX5UCPU" ⇒ "CPU Parameter"

■Module parameters of the CPU module

These parameters are required to execute each built-in function of the CPU module.

 "Navigation window" ⇒ "Parameter" ⇒ "FX5UCPU" ⇒ "Module Parameter"

■Memory card parameters

These parameters are required to execute functions that access the SD memory card.

 "Navigation window" ⇒ "Parameter" ⇒ "FX5UCPU" ⇒ "Memory Card Parameter"

■Module Parameter

Expansion Adapter and Intelligent Function Module requires setting of Module Parameter.

 "Navigation window" ⇒ "Parameter" ⇒ "Module Information" ⇒ (each expansion adapter or intelligent function module)
⇒ "Module Parameter"

When setting parameters from the Module configuration diagram

"CPU parameter" and "module parameter" can be set from the module configuration diagram. The following shows how to set them.

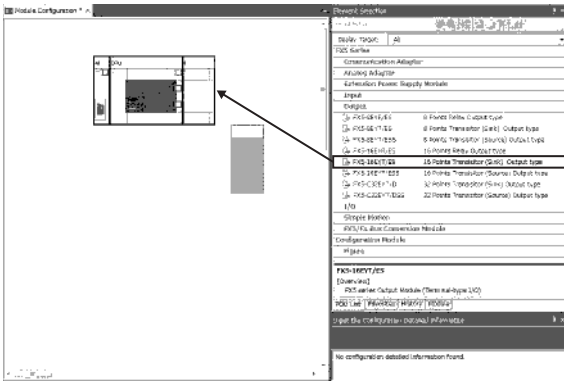

1. Drag each module to be used from the parts select window to the module configuration diagram with the mouse, and place the module to be coupled to the CPU module on the diagram.
2. Select [Edit] ⇒ [Parameter] ⇒ [Fix] on the menu bar.
3. When module labels are prepared in the configured modules, the window for adding module labels appears. Click the [Yes] button.
4. Open the parameter editor of each module by double-clicking the module having parameters that can be set.
5. Set parameters, and click the [Apply] button to close the window.

4.7 Programming

Create a program. This section describes how to create a program using the following program example.

Program example

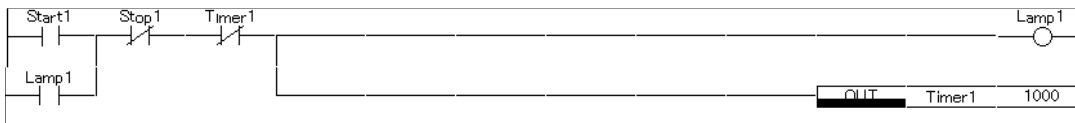

- When Start1 turns on, Timer1 starts counting, and Lamp1 turns on.
- When the current value of Timer1 reaches 1000, Lamp1 turns off.
- When Stop1 turns on, Lamp1 turns off.

Registering labels

Label is a variable whose name and data type can be declared by a user.

Use of labels allows programming without concern to devices and buffer memory addresses. For this reason, programs using labels can be used in other systems where the module configuration is different.

Labels can be registered on the label editor.

"Navigation window" ⇒ "Program" ⇒ "Scan" ⇒ "MAIN" ⇒ "ProgPou" ⇒ "Local Label"

Procedure

Register the label "Start1" in the program example, following the procedure below.

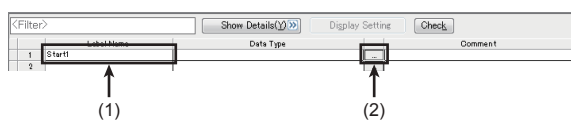

1. Enter the name, "Start1", in the "Label Name" field (1).
2. Click the button (2) on the right of the "Data Type" field to open the "Data Type Selection" window.
3. Specify the data type. Select "Bit", and click the [OK] button.

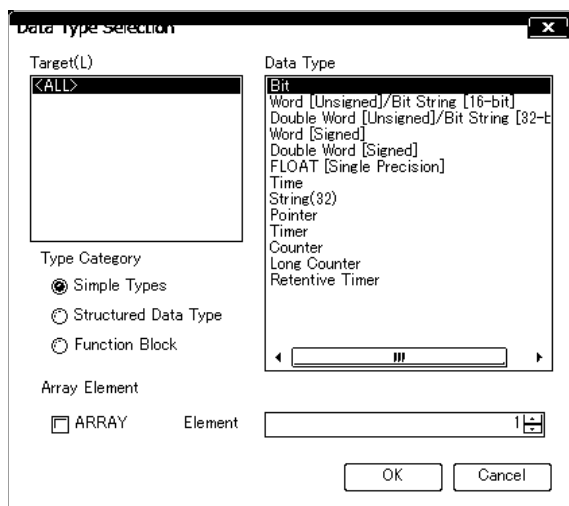

Register other labels in the program example in the same way.

Point

- The class, and constant of labels can be set as needed by clicking the [Show Details] button on the label editor.
- Labels can also be registered while programming without opening the label editor. (Page 33 Inserting program elements by key input)
- Devices can be assigned to global labels. Open the global label editor, and enter a device in the "Assign (Device/Label)" field.

Inserting program elements

Drag and drop required program elements to the ladder editor.

"Navigation window" ⇒ "Program" ⇒ "Scan" ⇒ "MAIN" ⇒ "ProgPou" ⇒ "Program"

Procedure

Insert a normally open contact of "Start1" in the program example, following the procedure below.

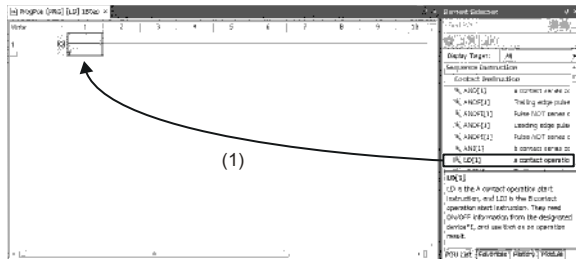

1. Select a program element from the Element Selection window, and drag and drop (1) it to the desired position in the ladder editor. In this example, drag and drop "LD[1]".

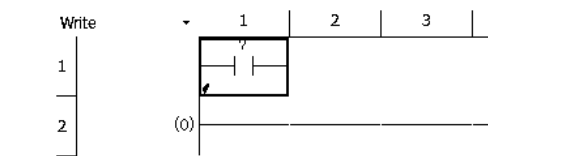

2. Double-click the inserted program element to open the ladder entry window, and click the [ExtD Dspl] button.

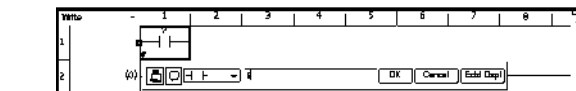

3. Specify the operand. In this example, enter "Start" for "s" in the "Device/Label" field (2).

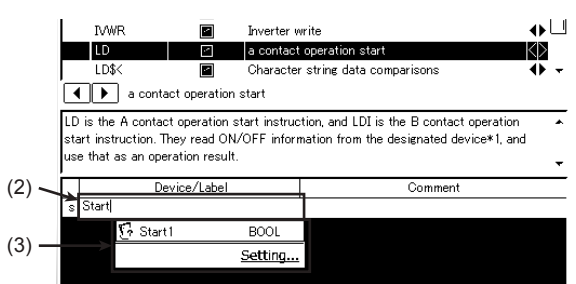

4. Select an item from the displayed list (3). In this example, select "Start1".

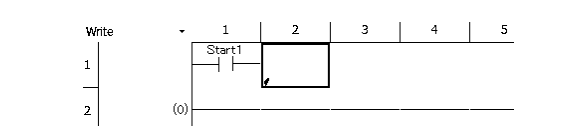

5. The normally open contact of "Start1" is inserted to the program.

Insert other program elements in the program example in the same way.

Point

Common instructions, such as contacts and coils, standard functions/function blocks, and user-defined function blocks/functions can be found in the [POU List] (1) in the Element Selection window. Narrow down the list using the drop-down menu (2) for "Display Target" and making a selection.

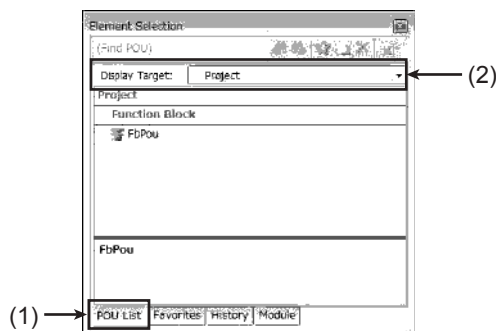

■ Inserting function blocks

Insert function blocks, following the procedure below.

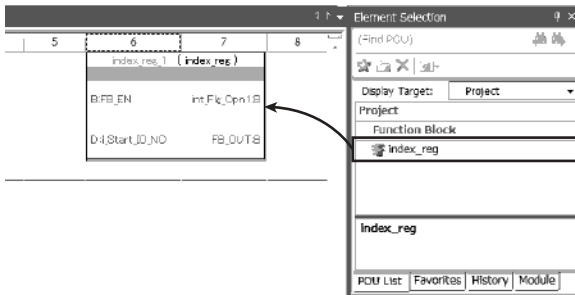

1. Select a function block from the Element Selection window, and drag and drop it to the desired position on the ladder editor.

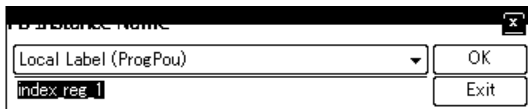

2. The "FB Instance Name" window opens. Select the target label (global label or local label), and enter an instance name.

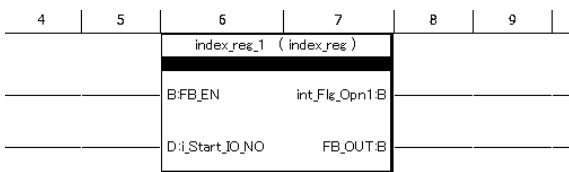

3. Select [Convert] ⇨ [Convert] on the menu bar. The ladder is converted, and the rungs are connected to the input and output labels of the FB instance.

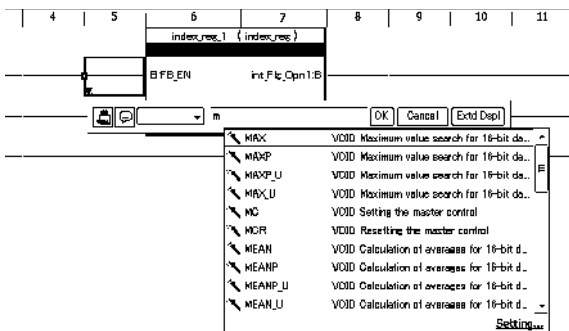

4. Add the input and output parts of the inserted function block to complete the program.

■ Creating function blocks/functions

User-defined function blocks/functions must be created before inserted to the program.

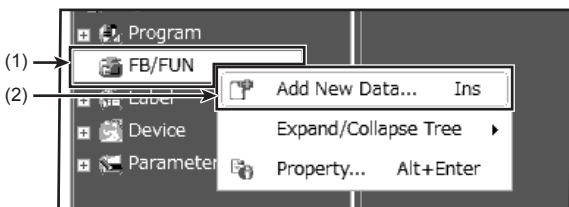

1. Right-click "FB/FUN" (1) on the Navigation window, and select "Add New Data" (2) to open the setting window.

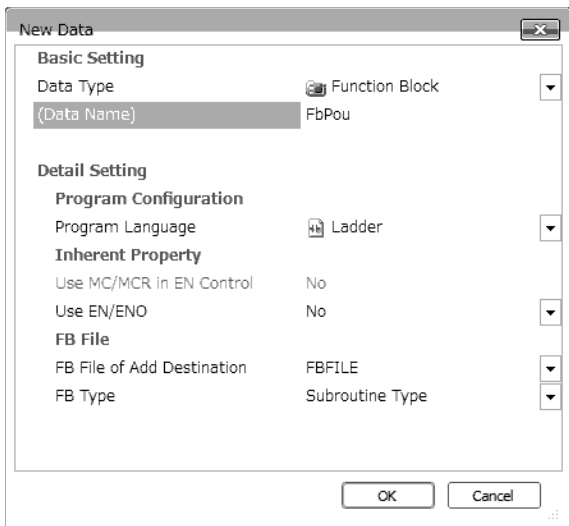

2. To create a function block, set the data type to "Function Block" using the drop-down list. To create a function, set the data type to "Function". Then, click the [OK] button.
3. Create the processing of the function block or function on the "Program" window.

Inserting program elements by key input

Program elements can be inserted by key input.

Procedure

Inserting a normally open contact of "Start1" in the program example, following the procedure below.

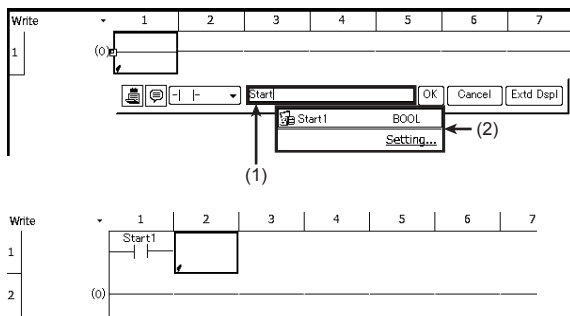

1. Click the insertion position on the ladder editor, and press **[F5]**
2. Enter the name, "Start", in the entry field (1). Select "Start1" from the displayed list (2).
3. The normally open contact of "Start1" is inserted to the program.

4

Point

A new label can be registered during insertion. Enter the name of a new label on the ladder entry window, and click the [OK] button. Then, specify the registered destination, class, and data type of the label on the "Undefined Label Registration" window, and click the [OK] button.

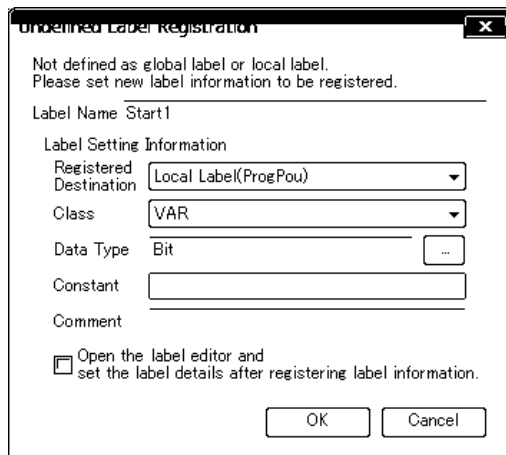

4.8 Converting the Program

Compile the input ladder blocks.

Procedure

1. Select [Convert] ⇒ [Convert] on the menu bar.
2. When the conversion processing completes and the input ladder blocks are compiled, the color of those ladder blocks changes from gray to white.

4.9 Saving the Project

Save the created project.

 [Project] ⇒ [Save as]

4.10 Writing Data to the CPU Module

Write the set parameters and the created program to the CPU module.

 [Online] ⇒ [Write to PLC]

Procedure

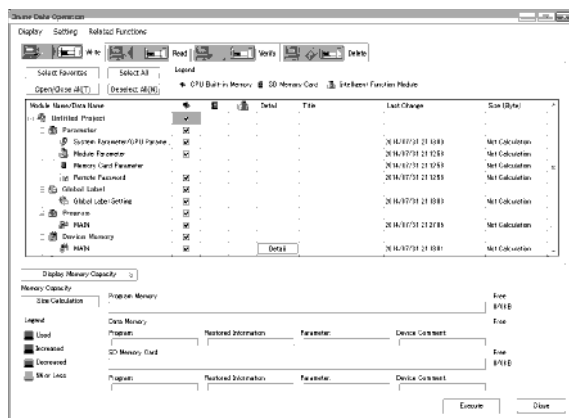

1. Select the system parameter file, CPU parameter file, module parameter file, and program file on the "Online Data Operation" window.
2. Click the [Execute] button.
3. After the write processing completes, click the [Close] button.

Point

- For the operation of the CPU module, the system parameter file, CPU parameter file, and program file must be written. For the operation of the expansion adapter, I/O modules and intelligent function modules, the module parameter files must be written as well.
- Use of the [Select Favorites] button enables users to easily select frequently-used files, such as the system parameter file, CPU parameter file, and program file. Register items as favorites on the window opened by selecting [Setting] ⇒ [Register Favorites Selection] on the menu bar.

4.11 Resetting the CPU Module

Reset the CPU module using the RUN/STOP/RESET switch located on the front of the CPU module.

Procedure

The following illustration is an example of the FX5U CPU module.

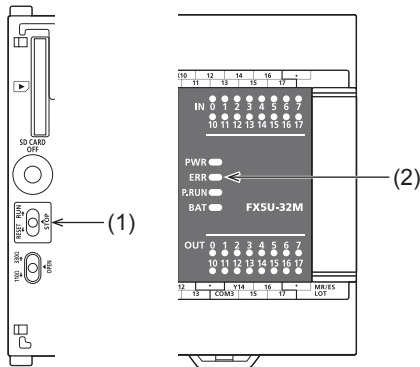

1. Set the RUN/STOP/RESET switch (1) to the RESET position for a second or longer.
2. Check that the ERROR LED (2) flashes for several times and turns off.
3. Set the switch back to the STOP position.

4

Point

Operate the RUN/STOP/RESET switch with your fingers. Use of a tool such as a screwdriver may damage the switch.

4.12 Executing the Program

Execute the program written to the programmable controller by using the RUN/STOP/RESET switch.

Procedure

The following illustration is an example of the FX5U CPU module.

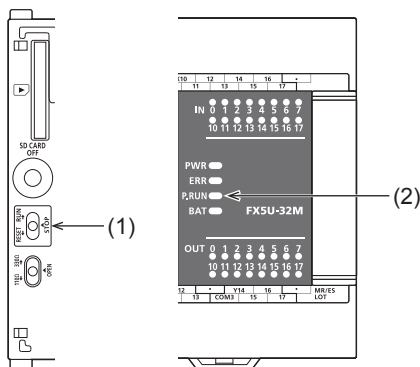

1. Set the RUN/STOP/RESET switch (1) to the RUN position.
2. Check that the P.RUN (2) turns on.

4.13 Monitoring the Program

Monitor the program operation using the engineering tool.

Monitoring on the monitor status bar

The LED status of the CPU module and the scan time can be monitored on the monitor status bar.

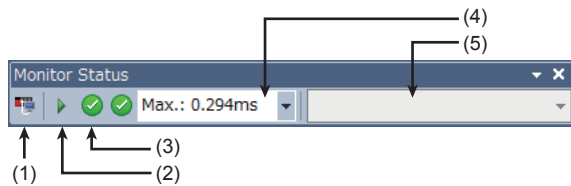

1. Select [Online] ⇒ [Monitor] ⇒ [Start Monitoring] on the menu bar.
2. Monitor the LED status of the CPU module and the scan time.

■Displayed item

No.	Item	Description	Icon	Meaning
(1)	Connection status	The connection status with the CPU module is displayed.		Connected with the CPU module
				Not connected with the CPU module
(2)	Operating status	The operating status of the CPU module in accordance with the RUN/STOP/RESET switch of the CPU module or the remote operation by the engineering tool is displayed. Click the icon. Then, "Remote operation" window appears. (GX Works3 Operating Manual)		RUN
				STOP
				PAUSE
(3)	ERROR LED status	The ERROR LED status of the CPU module is displayed. Click the icon. Then, "Module diagnostics" window appears. (Page 39 Module diagnostics (CPU Diagnostics))		Off
				On
				Flashing
(4)	Scan time details	The scan time details are displayed. Select the value to be displayed from the drop-down list (current value, maximum value, or minimum value).		
(5)	Monitor target selection	Specify the monitor target FB instance when monitoring a FB program.		

Monitoring on the ladder editor

The on/off states of contacts and coils and the current values of word devices and labels can be monitored on the ladder editor.

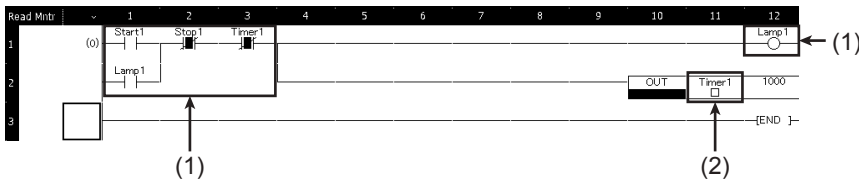

- (1) The on/off states of the contacts and coils are displayed.
- (2) The current value of the word/double word type data is displayed.

1. Select [Online] ⇒ [Monitor] ⇒ [Start Monitoring] on the menu bar.
2. Monitor the on/off states of contacts and coils and the current values of word devices and labels.

■ On/off state display

The on/off states are displayed on the editor as follows:

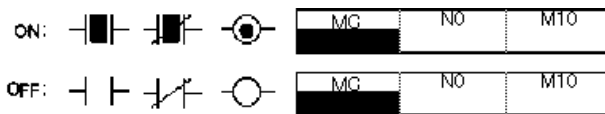

■ Changing the current value

To change the current value, select the cell on the ladder editor, and press **[Shift]** + double-click the cell or press **[Shift]** + **[Enter]** while the program is being monitored.

Point

The program can also be monitored on the Device/Buffer Memory Batch window of the Watch window. (GX Works3 Operating Manual)

4.14 Troubleshooting

This section describes errors that may occur during system operation, error causes, and actions to be taken.

For the troubleshooting specific to each module, refer to the manual for the module used.

Point

Saving the program and devices at the time of an error helps to analyze the error cause. (GX Works3 Operating Manual)

Troubleshooting procedure

When the system has any trouble, perform troubleshooting in the following order.

1. Check that each module is properly mounted and wired.
2. Check the LED status of the CPU module. (Page 38 Checking with LEDs)
3. Check the LED status of each intelligent function module. (User's manuals for each module)
4. Connects the engineering tool and execute the Module diagnostics(CPU Diagnostics) function. The error cause and the action to be taken can be displayed. (Page 39 Module diagnostics (CPU Diagnostics))
5. If the error cause cannot be identified in steps 1 to 3, troubleshoot by symptom. (User's manuals for each module)

Checking with LEDs

Check the module status with LEDs as a means to perform the primary diagnosis.

Point

Each LED status can be checked by using the Module diagnostics (CPU Diagnostics) of the engineering tool.
( GX Works3 Operating Manual)

Checking the PWR LED

If the PWR LED is turned off, check the following items.



Item to check	Cause and action
Measure the voltage input to the CPU module.	If the power source is not supplying the proper voltage, provide a power source that does.
Remove extension modules and all wiring other than the one for the power supply, and turn on the power supply.	If the PWR LED turns on in this condition, the service power supply may be shorted or overloaded. Reconnect the modules and wire one by one to identify the cause.

If the PWR LED still does not turn on even after the items shown above are checked, there may be a hardware issue. Consult your local Mitsubishi Electric representative.

Checking the BAT LED

If the BAT LED is turned on, check the following items.

The LED is valid when the optional battery is installed and the LED is set to "display" for battery errors by using the parameter.

Item to check	Cause and action
Check the installation of the battery.	Install the battery properly.
Check the battery voltage.	If the battery voltage is reduced, replace the battery with a new one. Battery voltage can be monitored with PLC data register SD8005. ( MELSEC iQ-F FX5U User's Manual (Hardware)) ( MELSEC iQ-F FX5UC User's Manual (Hardware))

Checking the ERR LED

If the ERR LED flashes, check the following items.

Item to check	Cause and action
Write system parameters, CPU parameters, and program files, and turn on the power supply again.	Programs or parameters may not be written or damaged. Since a CPU module with the factory default setting has no programs, the ERR LED flashes.

If the ERR LED is turned on, check the following items.

Item to check	Cause and action
Set the CPU module to the STOP status and turn on the power supply again.	When the ERR LED turns off, a watchdog timer error has probably occurred. Take any of the following measures. <ul style="list-style-type: none">• Review the program and avoid the maximum value (SD524, SD525) of the scan time exceeding the scan time monitoring time setting value set by the parameter.• Check that the input used for input interruption or pulse catch is not being abnormally turned on and off in one scan.• Check that the frequency of the pulse input to the high-speed counter is within the specified range.• Add some WDT instructions to the program and reset the watchdog timer several times in one scan.
Provide a different power supply to the CPU module.	If the ERR LED turns off, noise may have affected the module. Consider taking the following measures. <ul style="list-style-type: none">• Check the ground wiring, and reexamine the wiring route and installation location.• Fit a noise filter onto the power supply line.

If the ERR LED still does not turn off even after the items shown above are checked, there may be a hardware issue. Consult your local Mitsubishi Electric representative.

Checking the P.RUN LED

If the P.RUN LED is turned off, check the status of the ERR LED and take corrective actions. ( Page 38 Checking the ERR LED)

Troubleshooting using the engineering tool

Check the error or history using the engineering tool, and identify the error cause. More detailed information on the error as well as the error cause and action to be taken can be checked by using the engineering tool.

The engineering tool has the following functions for troubleshooting.

Function	Description
Module diagnostics (CPU Diagnostics)	This function diagnoses the module. (The current error and its details can be checked.)

For details on each function, refer to the following.

GX Works3 Operating Manual

Module diagnostics (CPU Diagnostics)

This function diagnoses CPU module, expansion adapter, and expansion board. (The current error and its details can be checked.)

Information required for troubleshooting, such as the current error, details and cause of the error, and action to be taken, are displayed. The incorrect parameter setting and program error location can also be identified by selecting the error and clicking the [Error Jump] button. On the [Module Information List] tab, the LED status and the switch status of the target module can be checked.

[Diagnostics]⇒[Module diagnostics(CPU Diagnostics)]

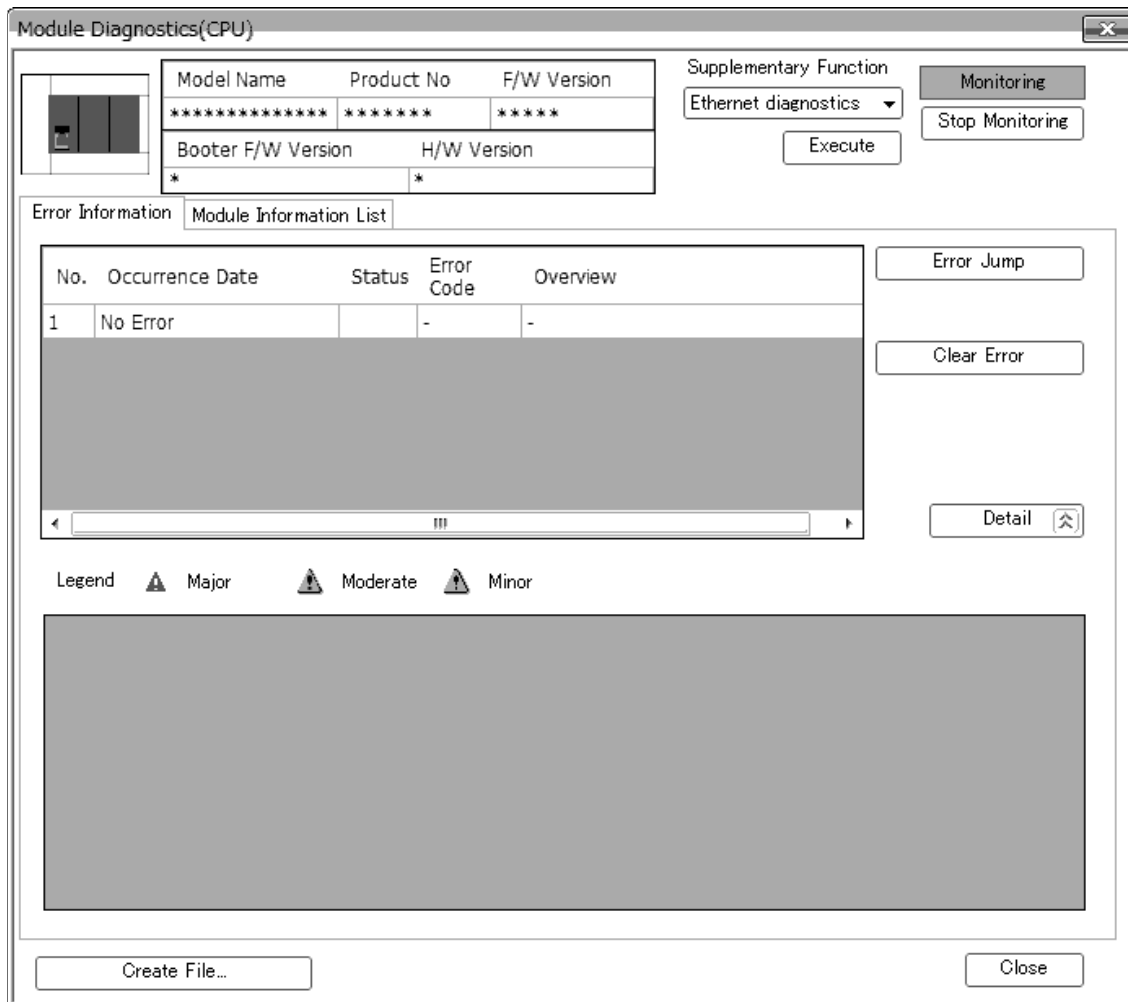

Appendix

Appendix 1 External Dimensions, Accessories

FX5U CPU module

FX5U-32M□

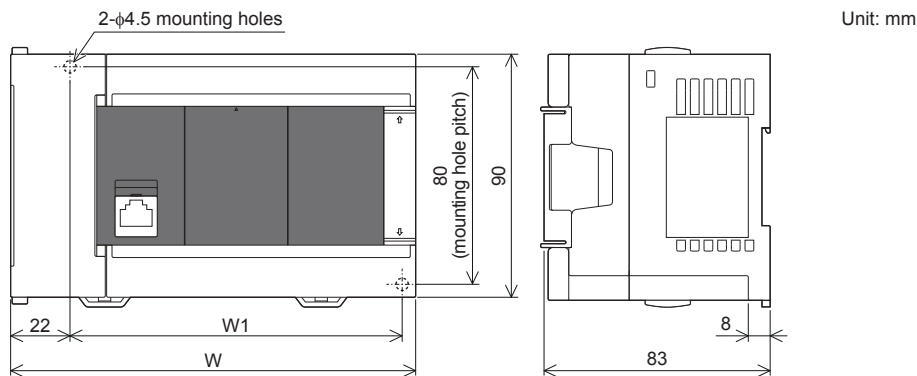

Model	W	W1 (mounting hole pitch)	Mass (weight)
FX5U-32MR/ES FX5U-32MT/ES FX5U-32MT/ESS FX5U-32MR/DS FX5U-32MT/DS FX5U-32MT/DSS	150 mm	123 mm	Approx 0.65 kg

- Exterior color : Main body: Munsell 0.6B7.6/0.2
- Accessories : Dust proof protection sheet, Manual supplied with product

FX5U-64M□, FX5U-80M□

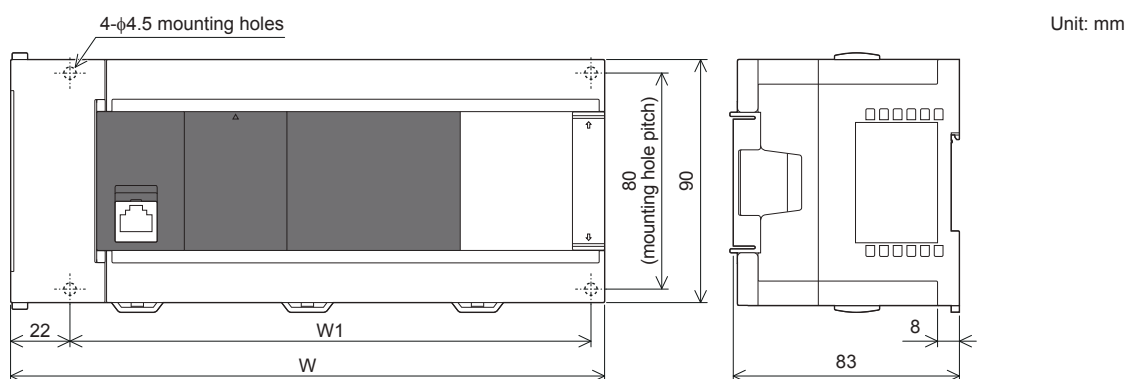

Model	W	W1 (mounting hole pitch)	Mass (weight)
FX5U-64MR/ES FX5U-64MT/ES FX5U-64MT/ESS	220 mm	193 mm	Approx. 1.0 kg
FX5U-80MR/ES FX5U-80MT/ES FX5U-80MT/ESS	285 mm	258 mm	Approx. 1.2 kg

- Exterior color : Main body: Munsell 0.6B7.6/0.2
- Accessories : Dust proof protection sheet, Manual supplied with product

FX5UC CPU module

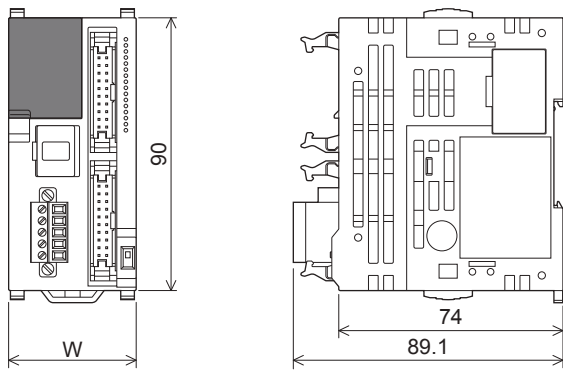

Unit: mm

Model	W	Mass (weight)
FX5UC-32MT/D FX5UC-32MT/DSS	42.1 mm	Approx 0.2 kg
FX5UC-64MT/D FX5UC-64MT/DSS	62.2 mm	Approx 0.3 kg
FX5UC-96MT/D FX5UC-96MT/DSS	82.3 mm	Approx 0.35 kg

- Exterior color

Main body: Munsell 0.6B7.6/0.2

- Accessories

Manual supplied with product

FX2NC-100MPCB power cable: 1m

FX2NC-100BPCB power cable: 1m (FX5UC-□MT/D only)

Appendix 2 Functions of FX5U CPU module

Functions of FX5U CPU module

FX5U CPU module earlier than Version 1.010 does not support the following functions.

- Online program change
- Diagnostics functions (Module Diagnostics)

Functions of GX Works3

When performing setting of FX5, programming operation, etc. using earlier than GX Works3 Version 1.007H, the following functions are not supported.

- Online program change
- Diagnostics functions (Module Diagnostics)

INDEX

B

BAT LED	13,16
Battery connector	14
Battery cover	17
Battery holder	14
Built-in analog function	20
Built-in analog I/O terminal block	14
Built-in Ethernet communication connector	13,16
Built-in Ethernet function	20
Built-in RS-485 communication terminal block	14,16

C

CARD LED	13,16
Clock function	18
Command processing time	18
Control system	18
CPU module fixing screw hole	15
Creating function blocks/functions	32

D

Data type selection window	30
DIN rail mounting groove	15,17
DIN rail mounting hook	13,16
DISP switch	16

E

ERR LED	13,16
Expansion adapter connecting hooks	13,16
Expansion adapter connector cover	15,17
Expansion board connector	14
Expansion board connector cover	13
Extension connector	14
Extension connector cover	13
Extension module connecting hook	16
External dimensions, accessories	40

F

FB instance name window	32
File storage capacity	18
Flash memory (Flash ROM) write count	18

G

Genuine product certification label	15,17
---	-------

H

High-speed input/output function	20
--	----

I

I/O display LED	16
Input connector	16
Input display LED	13
Input/output control system	18

L

Label	30
Ladder entry window	31,33
LED	38

M

Memory capacity	18
Memory card parameter	28
Memory management window	28
MODBUS RTU communication function	20
Module access device	19
Module parameter	28
Module parameters of the CPU module	28
Monitor status bar	36

N

Nameplate	15,17
No. of file register points	19
No. of index register points	19
No. of input/output points	18
No. of nesting points	19
No. of pointer points	19
No. of system device points	19
No. of user device points	19

O

Online data operation window	34
Operation specifications	18
Operation status display LED	16
Output connector	16
Output display LED	14

P

P.RUN LED	13,16
Power connector for CPU module	17
Power failure retention	18
Procedures before operation	22
Programming specifications	18
PWR LED	13,16

R

RD LED	13,16
RS-485 terminal resistor selector switch	14,17
RUN/STOP/RESET switch	14,17

S

SD LED	13,16
SD memory card disable switch	14,16
SD memory card slot	14,17
SD/RD LED	13,16
Serial communication function	20
Specify connection destination connection window	27
Subsequent extension connector cover	17
System parameter	28

T

Terminal	14
Terminal block cover	13
Terminal block mounting screws	14
Top cover	13

U

Undefined label registration window	33
---	----

MEMO

REVISIONS

Revision date	Revision	Description
October 2014	A	First Edition
January 2015	B	■Added or modified parts RELEVANT MANUALS, TERMS, Chapter 1, 2, 3, Section 4.1, 4.2, 4.3, 4.4, 4.5, 4.6, 4.10, 4.13, 4.14, Appendix 1, 2
April 2015	C	A part of the cover design is changed.
May 2016	D	■Added models FX5U-32MR/DS, FX5U-32MT/DS, FX5U-32MT/DSS, FX5UC-64MT/D, FX5UC-64MT/DSS, FX5UC- 96MT/D, FX5UC-96MT/DSS ■Added or modified parts RELEVANT MANUALS, TERMS, Chapter 3, Appendix 1

This manual confers no industrial property rights or any rights of any other kind, nor does it confer any patent licenses. Mitsubishi Electric Corporation cannot be held responsible for any problems involving industrial property rights which may occur as a result of using the contents noted in this manual.

© 2014 MITSUBISHI ELECTRIC CORPORATION

WARRANTY

Please confirm the following product warranty details before using this product.

1. Gratis Warranty Term and Gratis Warranty Range

If any faults or defects (hereinafter "Failure") found to be the responsibility of Mitsubishi occurs during use of the product within the gratis warranty term, the product shall be repaired at no cost via the sales representative or Mitsubishi Service Company. However, if repairs are required onsite at domestic or overseas location, expenses to send an engineer will be solely at the customer's discretion. Mitsubishi shall not be held responsible for any re-commissioning, maintenance, or testing on-site that involves replacement of the failed module.

[Gratis Warranty Term]

The gratis warranty term of the product shall be for one year after the date of purchase or delivery to a designated place. Note that after manufacture and shipment from Mitsubishi, the maximum distribution period shall be six (6) months, and the longest gratis warranty term after manufacturing shall be eighteen (18) months. The gratis warranty term of repair parts shall not exceed the gratis warranty term before repairs.

[Gratis Warranty Range]

- (1) The range shall be limited to normal use within the usage state, usage methods and usage environment, etc., which follow the conditions and precautions, etc., given in the instruction manual, user's manual and caution labels on the product.
- (2) Even within the gratis warranty term, repairs shall be charged for in the following cases.
 1. Failure occurring from inappropriate storage or handling, carelessness or negligence by the user. Failure caused by the user's hardware or software design.
 2. Failure caused by unapproved modifications, etc., to the product by the user.
 3. When the Mitsubishi product is assembled into a user's device, Failure that could have been avoided if functions or structures, judged as necessary in the legal safety measures the user's device is subject to or as necessary by industry standards, had been provided.
 4. Failure that could have been avoided if consumable parts (battery, backlight, fuse, etc.) designated in the instruction manual had been correctly serviced or replaced.
 5. Relay failure or output contact failure caused by usage beyond the specified life of contact (cycles).
 6. Failure caused by external irresistible forces such as fires or abnormal voltages, and failure caused by force majeure such as earthquakes, lightning, wind and water damage.
 7. Failure caused by reasons unpredictable by scientific technology standards at time of shipment from Mitsubishi.
 8. Any other failure found not to be the responsibility of Mitsubishi or that admitted not to be so by the user.

2. Onerous repair term after discontinuation of production

- (1) Mitsubishi shall accept onerous product repairs for seven (7) years after production of the product is discontinued.
Discontinuation of production shall be notified with Mitsubishi Technical Bulletins, etc.
- (2) Product supply (including repair parts) is not available after production is discontinued.

3. Overseas service

Overseas, repairs shall be accepted by Mitsubishi's local overseas FA Center. Note that the repair conditions at each FA Center may differ.

4. Exclusion of loss in opportunity and secondary loss from warranty liability

Regardless of the gratis warranty term, Mitsubishi shall not be liable for compensation to:

- (1) Damages caused by any cause found not to be the responsibility of Mitsubishi.
- (2) Loss in opportunity, lost profits incurred to the user by Failures of Mitsubishi products.
- (3) Special damages and secondary damages whether foreseeable or not, compensation for accidents, and compensation for damages to products other than Mitsubishi products.
- (4) Replacement by the user, maintenance of on-site equipment, start-up test run and other tasks.

5. Changes in product specifications

The specifications given in the catalogs, manuals or technical documents are subject to change without prior notice.

6. Product application

- (1) In using the Mitsubishi MELSEC programmable controller, the usage conditions shall be that the application will not lead to a major accident even if any problem or fault should occur in the programmable controller device, and that backup and fail-safe functions are systematically provided outside of the device for any problem or fault.
- (2) The Mitsubishi programmable controller has been designed and manufactured for applications in general industries, etc. Thus, applications in which the public could be affected such as in nuclear power plants and other power plants operated by respective power companies, and applications in which a special quality assurance system is required, such as for railway companies or public service purposes shall be excluded from the programmable controller applications.
In addition, applications in which human life or property that could be greatly affected, such as in aircraft, medical applications, incineration and fuel devices, manned transportation, equipment for recreation and amusement, and safety devices, shall also be excluded from the programmable controller range of applications.
However, in certain cases, some applications may be possible, providing the user consults their local Mitsubishi representative outlining the special requirements of the project, and providing that all parties concerned agree to the special circumstances, solely at the user's discretion.

TRADEMARKS

Microsoft® and Windows® are either registered trademarks or trademarks of Microsoft Corporation in the United States and/or other countries.

Ethernet is a trademark of Xerox Corporation.

MODBUS® is a registered trademark of Schneider Electric SA.

Phillips is a registered trademark of Phillips Screw Company.

SD logo and SDHC logo are trademarks or registered trademarks of SD-3C, LLC.



The company name and the product name to be described in this manual are the registered trademarks or trademarks of each company.

Manual number: JY997D58201D

Model: FX5-U-IN-E

Model code: 09R545

When exported from Japan, this manual does not require application to the Ministry of Economy, Trade and Industry for service transaction permission.

MITSUBISHI ELECTRIC CORPORATION

HEAD OFFICE: TOKYO BUILDING, 2-7-3 MARUNOUCHI, CHIYODA-KU, TOKYO 100-8310, JAPAN

Specifications are subject to change without notice.