



PROGRAMMABLE CONTROLLERS
MELSEC iQ-F
 MELSEC iQ-F FX5UC CPU Module

Hardware Manual



Manual Number	JY997D61001
Revision	C
Date	October 2015

This manual describes the part names, dimensions, installation, cabling and specifications for the product. This manual is extracted from MELSEC iQ-F FX5UC User's Manual (Hardware). Refer to MELSEC iQ-F FX5UC User's Manual (Hardware) for more details. Before use, read this manual and manuals of relevant products fully to acquire proficiency in the handling and operating the product. Make sure to learn all the product information, safety information, and precautions.

And, store this manual in a safe place so that you can take it out and read it whenever necessary. Always forward it to the end user.

Registration: Ethernet is a trademark of Xerox Corporation. MODBUS® is a registered trademark of Schneider Electric SA. The company name and the product name to be described in this manual are the registered trademarks or trademarks of each company.

Effective October 2015
 Specifications are subject to change without notice.
 © 2015 MITSUBISHI ELECTRIC CORPORATION

Safety Precaution (Read these precautions before use.)

This manual classifies the safety precautions into two categories:

WARNING and **CAUTION**.

WARNING	Indicates that incorrect handling may cause hazardous conditions, resulting in death or severe injury.
CAUTION	Indicates that incorrect handling may cause hazardous conditions, resulting in minor or moderate injury or property damage.

Depending on the circumstances, procedures indicated by **CAUTION** may also cause severe injury.
 It is important to follow all precautions for personal safety.

STARTUP AND MAINTENANCE PRECAUTIONS	WARNING
<ul style="list-style-type: none"> Do not touch any terminal while the PLC's power is on. Doing so may cause electric shock or malfunctions. Before cleaning or retightening terminals, cut off all phases of the power supply externally. Failure to do so in the power ON status may cause electric shock. Before modifying the program in mid-operation, forcing output, running or stopping the PLC, read through this manual carefully, and ensure complete safety. An operation error may damage the machinery or cause accidents. Do not change the program in the PLC from two or more peripheral equipment devices at the same time. (i.e. from an engineering tool and a GOT) Doing so may cause destruction or malfunction of the PLC program. 	

STARTUP AND MAINTENANCE PRECAUTIONS	WARNING
<ul style="list-style-type: none"> Use the battery for memory backup in conformance to the MELSEC iQ-F FX5UC User's Manual (Hardware). <ul style="list-style-type: none"> Use the battery for the specified purpose only. Connect the battery correctly. Do not charge, disassemble, heat, put in fire, short-circuit, connect reversely, weld, swallow or burn the battery, or apply excessive force (vibration, impact, drop, etc.) to the battery. Do not store or use the battery at high temperatures or expose to direct sunlight. Do not expose to water, bring near fire or touch liquid leakage or other contents directly. Incorrect handling of the battery may cause excessive heat, bursting, ignition, liquid leakage or deformation, and lead to injury, fire or failures and malfunction of facilities and other equipment.	

STARTUP AND MAINTENANCE PRECAUTIONS	CAUTION
<ul style="list-style-type: none"> Do not disassemble or modify the PLC. Doing so may cause fire, equipment failures, or malfunctions. For repair, contact your local Mitsubishi Electric representative. Turn off the power to the PLC before connecting or disconnecting any extension cable. Failure to do so may cause equipment failures or malfunctions. Turn off the power to the PLC before attaching or detaching the following devices. Failure to do so may cause equipment failures or malfunctions. <ul style="list-style-type: none"> Peripheral devices, and expansion adapter Extension modules, bus conversion module, connector conversion module, and battery 	

DISPOSAL PRECAUTIONS	CAUTION
<ul style="list-style-type: none"> Please contact a certified electronic waste disposal company for the environmentally safe recycling and disposal of your device. When disposing of batteries, separate them from other waste according to local regulations. (For details on the Battery Directive in EU countries, refer to the MELSEC iQ-F FX5UC User's Manual (Hardware).) 	

TRANSPORTATION PRECAUTIONS	CAUTION
<ul style="list-style-type: none"> When transporting the PLC with the optional battery, turn on the PLC before shipment, confirm that the battery mode is set in PLC parameters and the BAT LED is OFF, and check the battery life. If the PLC is transported with the BAT LED ON or the battery exhausted, the battery-backed data may be lost during transportation. The PLC is a precision instrument. During transportation, avoid impacts larger than those specified in the general specifications (Section 2.1) by using dedicated packaging boxes and shock-absorbing pallets. Failure to do so may cause failures in the PLC. After transportation, verify operation of the PLC and check for damage of the mounting part, etc. When transporting lithium batteries, follow required transportation regulations. (For details on the regulated products, refer to the MELSEC iQ-F FX5UC User's Manual (Hardware).) 	

Associated manuals

How to obtain manuals
For the necessary product manuals or documents, consult with your local Mitsubishi Electric representative.

Industrial automation
Elincom Group
 European Union: www.elinco.eu
 Russia: www.elinc.ru

Associated manuals

FX5UC CPU module comes with this document (hardware manual). For a detailed explanation of the FX5UC CPU module hardware and information on instructions for PLC programming and intelligent function module, refer to the relevant documents.

Manual name	Manual No.	Description
MELSEC iQ-F FX5 User's Manual (Startup)	JY997D58201	Explains performance specifications, procedures before operation, and troubleshooting of the FX5 CPU module.
MELSEC iQ-F FX5UC User's Manual (Hardware)	JY997D61401	Explains FX5UC CPU module specification details for I/O, wiring, installation, and maintenance.
MELSEC iQ-F FX5 User's Manual (Serial Communication)	JY997D55901	Explains the N-N network, MELSEC Communication protocol, inverter communication and non-protocol communication.
MELSEC iQ-F FX5 User's Manual (MODBUS Communication)	JY997D56101	Explains the MODBUS serial communication.
MELSEC iQ-F FX5 User's Manual (Ethernet Communication)	JY997D56201	Functions for communication via built-in Ethernet port.

Certification of UL, cUL standards

Please consult with Mitsubishi Electric for information on UL, cUL standard practices and the corresponding types of equipment.

Compliance with EC directive (CE Marking)

This document does not guarantee that a mechanical system including this product will comply with the following standards. Compliance to EMC directive of the entire mechanical system should be checked by the user/manufacturer. For more details please contact the local Mitsubishi Electric sales site.

Attention

- This product is designed for use in industrial applications.

Note

- Authorized Representative in the European Community: Mitsubishi Electric Europe B.V. Gothaer Str. 8, 40880 Ratingen, Germany

Caution for compliance with EC Directive

Installation in Enclosure

Programmable controllers are open-type devices that must be installed and used within conductive control boxes. Please use the FX5UC programmable controllers while installed in conductive shielded control boxes. Please secure the control box lid to the control box (for conduction). Installation within a control box greatly affects the safety of the system and aids in shielding noise from the programmable controller. For other cautions, refer to the MELSEC iQ-F FX5UC User's Manual (Hardware).

Incorporated items

Check if the following product and items are included in the package:

	Included Items	
■ CPU module	Product	1 module
	FX2NC-100MPCB [1 m (3'3"), three wire]	1 cable
	FX2NC-100BPCB [1 m (3'3"), two wire]	1 cable
	Manuals [Japanese/English]	1 manual
	Manuals [Chinese]	1 manual
FX5UC-□MT/DSS (□: 32, 64, 96)	Product	1 module
	FX2NC-100MPCB [1 m (3'3"), three wire]	1 cable
	Manuals [Japanese/English]	1 manual
	Manuals [Chinese]	1 manual

	Included Items	
■ I/O module	Product	1 module
	FX5-□□EX/D FX5-C32ET/D (□: 16, 32)	FX2NC-10BPCB1 [0.1 m (3.93"), double-ended]
FX5-□□EX/DSS FX5-C32ET/DSS FX5-□□EY/T/D(SS) (□: 16, 32)	Product	1 module

1. Outline

1.1 Part names

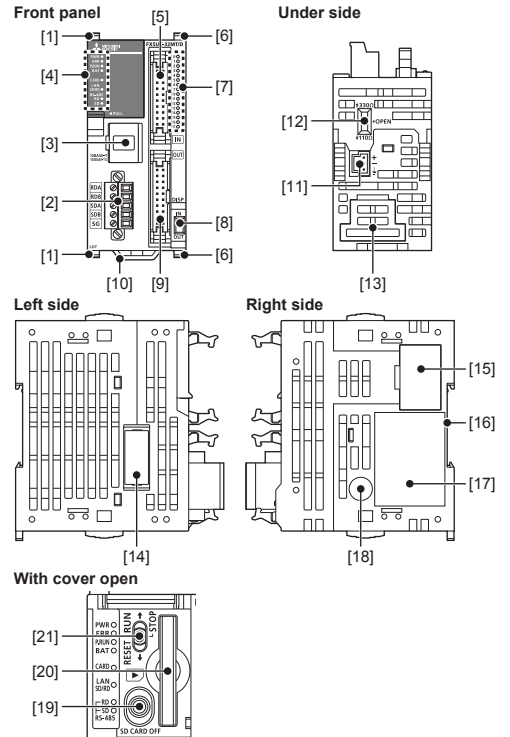

No.	Name
[1]	Expansion adapter connecting hooks
[2]	Built-in RS-485 communication terminal block
[3]	Built-in Ethernet communication connector (with cover)

No.	Name	
	Operation status display LEDs	
	PWR	Green On while the PLC is powered.
	ERR ^{*1}	Red Lit/flashing when an error occurs.
	P.RUN	Green On while the PLC is running.
	BAT	Red Lit when the battery voltage drops.
[4]	CARD	Green Lit when the SD memory card is inserted.
	SD/RD	Green Lit when data is sent or received through communication via built-in Ethernet.
	RD	Green Lit when data is received through communication via built-in RS-485.
	SD	Green Lit when data is sent through communication via built-in RS-485.
[5]	Input connector	
[6]	Extension module connection hooks	
[7]	Input/Output display LEDs (Green)	
[8]	DISP switch (for switching Input/Output display LEDs)	
[9]	Output connector	
[10]	DIN rail mounting hooks	
[11]	Power connector for CPU module	
[12]	RS-485 terminal resistor selector switch	
[13]	Battery cover	
[14]	Expansion adapter connector cover	
[15]	Extension connector cover	
[16]	DIN rail mounting groove	
[17]	Nameplate ^{*2}	
[18]	Genuine product certification label ^{*2}	
[19]	SD memory card disable switch	
[20]	SD memory card slot	
[21]	RUN/STOP/RESET switch	

*1 When powered on in the factory default state, ERR LED starts flashing because there is no program. For details, refer to the following manual.
→ MELSEC iQ-F FX5UC User's Manual (Hardware).

*2 Products that do not have the genuine product certification label or nameplate are not covered by the warranty.

1.2 External dimensions and weight

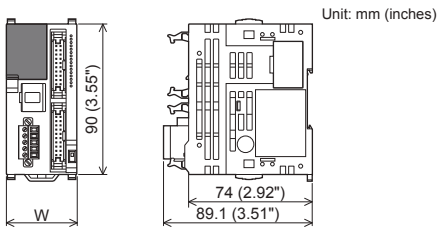

Model name	W: mm (inches)	MASS (Weight): kg (lbs.)
FX5UC-32MT/D FX5UC-32MT/DSS	42.1 (1.66")	Approx. 0.2 (0.44 lbs)
FX5UC-64MT/D FX5UC-64MT/DSS	62.2 (2.45")	Approx. 0.3 (0.66 lbs)
FX5UC-96MT/D FX5UC-96MT/DSS	82.3 (3.25")	Approx. 0.35 (0.77 lbs)

Outer paint color Body: Munsell 0.6B7.6/0.2

2. Installation (general specifications)

As for installation of the I/O modules and expansion adapters, refer to MELSEC iQ-F FX5UC User's Manual (Hardware).

INSTALLATION PRECAUTIONS **WARNING**

- Use the product within the generic environment specifications described in section 2.1 of this manual. Never use the product in areas with excessive dust, oily smoke, conductive dusts, corrosive gas (salt air, Cl₂, H₂S, SO₂ or NO₂), flammable gas, vibration or impacts, or expose it to high temperature, condensation, or rain and wind. If the product is used in such conditions, electric shock, fire, malfunctions, deterioration or damage may occur.

INSTALLATION PRECAUTIONS **CAUTION**

- Do not touch the conductive parts of the product directly. Doing so may cause device failures or malfunctions.
- When drilling screw holes or wiring, make sure cutting or wire debris does not enter the ventilation slits of the PLC. Failure to do so may cause fire, equipment failures or malfunctions.
- Install the product on a flat surface. If the mounting surface is rough, undue force will be applied to the PC board, thereby causing nonconformities.
- Install the product securely using a DIN rail or mounting screws.
- Connect the extension cables, peripheral device cables, input/output cables and battery connecting cable securely to their designated connectors. Loose connections may cause malfunctions.
- Turn off the power to the PLC before attaching or detaching the following devices. Failure to do so may cause equipment failures or malfunctions.
 - Peripheral devices, and expansion adapter
 - Extension modules, bus conversion module, connector conversion module, and battery

2.1 Generic specifications

Item	Specification				
Operating ambient temperature ^{*1}	0 to 55 °C (32 to 131 °F) ^{*2}				
Storage ambient temperature	-25 to 75 °C (-13 to 167 °F)				
Operating ambient humidity	5 to 95%RH, non-condensing				
Storage ambient humidity	5 to 95%RH, non-condensing				
Vibration resistance ^{*3*}	Installed on DIN rail	Frequency (Hz)	Acceleration (m/s ²)	Half amplitude (mm)	Sweep count
		5 to 8.4	—	1.75	
		8.4 to 150	4.9	—	10 times each in X, Y, Z directions (80 min in each direction)
Shock resistance ^{*3}	147 m/s ² Acceleration, Action time: 11 ms, 3 times by half-sine pulse in each direction X, Y, and Z				
Noise durability	By noise simulator of 1000 Vp-p noise voltage, 1 μs noise width and 30 to 100 Hz noise frequency				
Dielectric withstand voltage ^{*5}	500 V AC for 1 minute		Between batch of all terminals and ground terminal		
Insulation resistance ^{*5}	10 MΩ or higher by 500 V DC insulation resistance tester				
Grounding	Class D grounding (Grounding resistance: 100 Ω or less) <Common grounding with a heavy electrical system is not allowed.> ^{*6}				
Working atmosphere	Free from corrosive or flammable gas and excessive conductive dusts				
Operating altitude ^{*7}	0 to 2000 m				

Item	Specification
Installation location	Inside a control panel
Overvoltage category ^{*8}	II or less
Pollution degree ^{*9}	2 or less
Equipment class	Class 2

*1 The simultaneous ON ratio of available PLC inputs or outputs changes with respect to the ambient temperature, refer to MELSEC iQ-F FX5UC User's Manual (Hardware).

*2 For intelligent function modules, refer to the manual for each product.

*3 The criterion is shown in IEC61131-2.

*4 When the system has equipment which specification values are lower than above mentioned vibration resistance specification values, the vibration resistance specification of the whole system is corresponding to the lower specification.

*5 For dielectric withstand voltage test and insulation resistance test of each product, refer to the following manual.
→ Refer to MELSEC iQ-F FX5UC User's Manual (Hardware).

*6 For grounding, refer to Section 3.3.

*7 The PLC cannot be used at a pressure higher than the atmospheric pressure to avoid damage.

*8 This indicates the section of the power supply to which the equipment is assumed to be connected between the public electrical power distribution network and the machinery within premises. Category II applies to equipment for which electrical power is supplied from fixed facilities. The surge voltage withstand level for up to the rated voltage of 300 V is 2500 V.

*9 This index indicates the degree to which conductive material is generated in the environment in which the equipment is used. Pollution level 2 is when only non-conductive pollution occurs. Temporary conductivity caused by condensation must be expected occasionally.

2.2 Installation location

Install the PLC in an environment conforming to the generic specifications (Section 2.1), installation precautions.

Installation location in enclosure

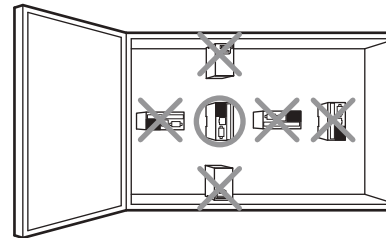

Space in enclosure

Extension devices can be connected on the left and right sides of the CPU module. If you intend to add extension devices in the future, keep necessary spaces on the left and right sides.

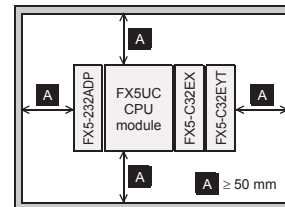

2.3 Procedures for installing to and detaching from DIN rail

The products can be installed on a DIN46277 rail [35 mm (1.38") wide]. This section explains the installations of the CPU modules.

2.3.1 Installation

1) Push out all DIN rail mounting hooks (below fig. A)

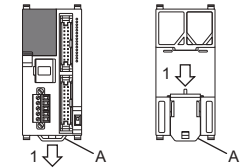

2) Fit the upper edge of the DIN rail mounting groove (right fig. B) onto the DIN rail.

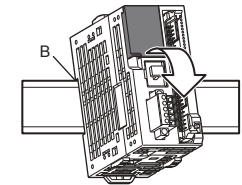

3) Lock the DIN rail mounting hooks (below fig. C) while pressing the PLC against the DIN rail.

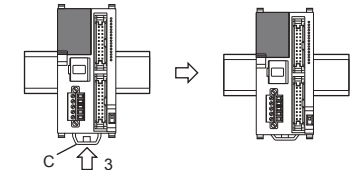

2.4 Connection of power supply connector

Use the power connector to supply power to the CPU module. For details, refer to MELSEC iQ-F FX5UC User's Manual (Hardware).

2.5 Connection to input/output connector

The input/output connectors of the CPU modules conform to MIL-C-83503. For details, refer to MELSEC iQ-F FX5UC User's Manual (Hardware).

1) Compliant connectors (commercially available connectors)
Use a 20-pin (1-key) socket connector conforming to MIL-C-83503. Confirm in advance that the connectors do not interfere with other parts including connector covers.

2) Input/output cables (available from Mitsubishi)
Input/output cables with attached connectors are available.

Model names	Length	Description	Shape
FX-16E-500CAB-S	5 m (16'4")	General-purpose input/output cable	<ul style="list-style-type: none"> Single wire (Wire color: red) PLC side: A 20-pin connector
FX-16E-150CAB	1.5 m (4'11")	Cables for connecting the terminal module with input/output connectors. For terminal module connection, refer to MELSEC iQ-F FX5UC User's Manual (Hardware).	<ul style="list-style-type: none"> Flat cables (with tube) A 20-pin connector at both ends
FX-16E-300CAB	3 m (9'10")		
FX-16E-500CAB	5 m (16'4")		<ul style="list-style-type: none"> Round multicore cables A 20-pin connector at both ends
FX-16E-150CAB-R	1.5 m (4'11")		
FX-16E-300CAB-R	3 m (9'10")		
FX-16E-500CAB-R	5 m (16'4")		

3) Connectors for user-made input/output cables (available from Mitsubishi)
Users should provide electric wires and a pressure bonding tool.

Model name and composition of input/output connector		Applicable electric wire (UL-1061 are recommended) and tool		
Our model name	Details of part (made by DDK Ltd.)	Electric wire size	Pressure bonding tool (made by DDK Ltd.)	
FX2C-I/O-CON for flat cable	10-piece set Solderless connector FRC2-A020-30S	AWG28 (0.1 mm ²) 1.27 pitch, 20-core	357J-4674D: Main body 357J-4664N: Attachment	
FX2C-I/O-CON-S for bulk wire	5-piece set Housing HU-200S2-001 Solderless contact HU-411S	AWG22 (0.3 mm ²)	357J-5538	
FX2C-I/O-CON-SA for bulk wire	5-piece set Housing HU-200S2-001 Solderless contact HU-411SA	AWG20 (0.5 mm ²)	357J-13963	

4) Certified connectors (commercially available connectors)
Connectors made by DDK Ltd. shown in item 3).

3. Specifications and examples of external wiring

As for the details of the power supply wiring and input/output wiring, refer to MELSEC IQ-F FX5UC User's Manual (Hardware).

DESIGN PRECAUTIONS **WARNING**

- Make sure to set up the following safety circuits outside the PLC to ensure safe system operation even during external power supply problems or PLC failure. Otherwise, malfunctions may cause serious accidents.
 - Most importantly, set up the following: an emergency stop circuit, a protection circuit, an interlock circuit for opposite movements (such as forward vs. reverse rotation), and an interlock circuit to prevent damage to the equipment at the upper and lower positioning limits.
 - Note that when the CPU module detects an error, such as a watchdog timer error, during self-diagnosis, all outputs are turned off. Also, when an error that cannot be detected by the CPU module occurs in an input/output control block, output control may be disabled. External circuits and mechanisms should be designed to ensure safe machine operation in such a case.
 - Note that when an error occurs in a relay or transistor of an output circuit, the output might stay on or off. For output signals that may lead to serious accidents, external circuits and mechanisms should be designed to ensure safe machine operation.
- Construct an interlock circuit in the program to ensure safe operation for the whole system when executing control (for data change) of the PLC in operation. Read the manual thoroughly and sufficiently ensure complete safety before executing other controls (for program change, parameter change, forced output and operation status change) of the PLC in operation. Otherwise, improper operation may damage machines or cause accidents.

WIRING PRECAUTIONS **WARNING**

- Make sure to cut off all phases of the power supply externally before attempting installation or wiring work. Failure to do so may cause electric shock or damage to the product.
- Make sure to attach the terminal cover, provided as an accessory, before turning on the power or initiating operation after installation or wiring work. Failure to do so may cause electric shock.
- The temperature rating of the cable should be 80°C or more.
- When drilling screw holes or wiring, make sure cutting or wire debris does not enter the ventilation slits. Failure to do so may cause fire, equipment failures or malfunctions.

WIRING PRECAUTIONS **WARNING**

- Make sure to wire the terminal block (European type) in accordance with the following precautions. Failure to do so may cause electric shock, equipment failures, a short-circuit, wire breakage, malfunctions, or damage to the product.
 - Wire terminals should follow the dimensions described in the manual.
 - Tightening torque should follow the specifications in the manual.
 - Twist the ends of stranded wires and make sure that there are no loose wires.
 - Do not solder-plate the electric wire ends.
 - Do not connect more than the specified number of wires or electric wires of unspecified size.
 - Affix the electric wires so that neither the terminal block nor the connected parts are directly stressed.

WIRING PRECAUTIONS **CAUTION**

- Perform class D grounding (grounding resistance: 100 Ω or less) of the grounding terminal on the CPU module and extension modules with a wire 2 mm² or thicker. Do not use common grounding with heavy electrical systems (refer to section 3.3).
- Connect the power supply wiring to the dedicated terminals described in this manual. If an AC power supply is connected to a DC input/output terminal or DC power supply terminal, the PLC will burn out.
- Do not wire vacant terminals externally. Doing so may damage the product.
- Make sure to observe the following precautions in order to prevent any damage to the machinery or accidents due to malfunction of the PLC caused by abnormal data written to the PLC due to the effects of noise.
 - Do not bundle the power line, control line and communication cables together with or lay them close to the main circuit, high-voltage line, load line or power line. As a guideline, lay the power line, control line and communication cables at least 100 mm (3.94") away from the main circuit, high-voltage line, load line or power line.
 - Ground the shield of the shielded wire or shielded cable at one point on the PLC. However, do not use common grounding with heavy electrical systems.

3.1 Cable end treatment and tightening torque

3.1.1 European type terminal block

1) Wire size

No. of wires per terminal	Wire size	
	Solid wire/Stranded wire	Ferrules with insulating sleeve
1	AWG22 to 20	AWG22 to 20
2	AWG22	—

2) Treatment of wire ends
Strip the coating of strand wire and twist the cable core before connecting it, or strip the coating of single wire before connecting it. An alternative connection is to use a ferrule with insulating sleeve.

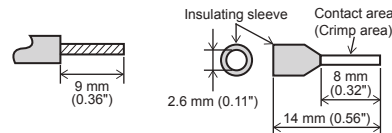

Manufacturer	Model	Caulking tool
Phoenix Contact GmbH & Co. KG	AI 0.5-6WH	CRIMPFOX 6

When using a wire ferrule with an insulating sleeve, choose a wire with proper cable sheath referring to the above outside dimensions, otherwise the wire cannot be inserted easily. Tighten the screws to a torque of 0.22 to 0.25 N·m. Do not tighten terminal screws exceeding with a torque outside the above-mentioned range. Failure to do so may cause equipment failures or malfunctions.

3) Tool
For tightening the terminal, use a commercially available small screwdriver having a straight form that is not widened toward the end as shown right.

Note:
If the diameter of screwdriver grip is too small, tightening torque may not be achieved. To achieve the appropriate tightening torque shown in the table above, use the following screwdriver or appropriate replacement (grip diameter: approximately 25 mm (0.98")).

Manufacturer	Model names
Phoenix Contact GmbH & Co. KG	SZS 0.4x2.5

3.2 Power supply specifications and external wiring

3.2.1 Power supply specifications [CPU module]

Item	Specification
Power supply voltage	24 V DC
Voltage fluctuation range	+20%, -15%
Allowable instantaneous power failure time	Operation can be continued upon occurrence of instantaneous power failure for 5 ms or less.
Power fuse	125 V 3.15 A Time-lag Fuse
Rush current	FX5UC-32MT/□ 35 A max. 0.5 ms or less/24 V DC
	FX5UC-64MT/□ FX5UC-96MT/□ 40 A max. 0.5 ms or less/24 V DC
	FX5UC-32MT/□ FX5UC-64MT/□ FX5UC-96MT/□ 5 W/24 V DC [30 W/24 V DC +20%, -15%]
Power consumption *1	FX5UC-32MT/□ 8 W/24 V DC [33 W/24 V DC +20%, -15%]
	FX5UC-64MT/□ 11 W/24 V DC [36 W/24 V DC +20%, -15%]
	FX5UC-96MT/□ 11 W/24 V DC [36 W/24 V DC +20%, -15%]
24 V DC built-in power supply capacity	500 mA
5 V DC built-in power supply capacity	720 mA

*1 This item shows value when only the CPU module is used. The value in [] is the value in the maximum configuration connectable to the CPU module. (The value does not include the external 24 V DC power supply of extension devices)

3.2.2 Example of external wiring

24 V DC power is supplied to the CPU module. CPU module supplies power through dedicated power connector. For the details, refer to the MELSEC IQ-F FX5UC User's Manual (Hardware).

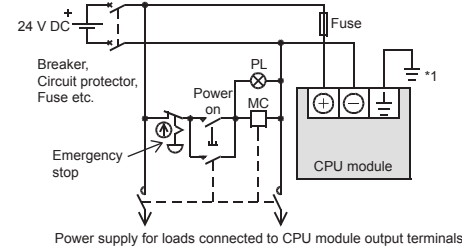

*1 Class D grounding
See section 3.3 for details.

3.3 Grounding

Ground the PLC as stated below.

- Perform class D grounding. (Grounding resistance: 100 Ω or less)
- Ground the PLC independently if possible. If it cannot be grounded independently, ground it jointly as shown below.

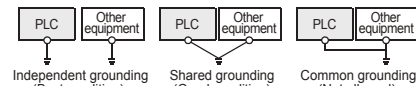

Position the grounding point as close to the PLC as possible to decrease the length of the ground wire.

3.4 Input specifications and external wiring

3.4.1 Input specifications [24 V DC input type]

Item		Specification
Input signal voltage		24 V DC +20%, -15%
Input impedance	CPU module X000 to X017	4.3 kΩ
	X020 and subsequent	5.6 kΩ
I/O module		5.6 kΩ
Input signal current	CPU module X000 to X017	5.3 mA/24 V DC
	X020 and subsequent	4.0 mA/24 V DC
I/O module		4.0 mA/24 V DC
ON input sensitivity current	CPU module X020 and subsequent	3.0 mA or more
	I/O module	3.0 mA or more
OFF input sensitivity current		1.5 mA or less
Input response time		Refer to MELSEC IQ-F FX5UC User's Manual (Hardware)
Input signal form	FX5UC-□MT/D FX5-C□EX/D FX5-C32ET/D	No-voltage contact input NPN open collector transistor
	FX5UC-□MT/DSS FX5-C□EX/DS FX5-C32ET/DSS	<ul style="list-style-type: none"> Sink input: No-voltage contact input NPN open collector transistor Source input: No-voltage contact input PNP open collector transistor
		LED on panel turns on when input. (DISP switch IN side.)

3.4.2 Examples of input wiring

1. Examples of input wiring (FX5UC-□MT/D)

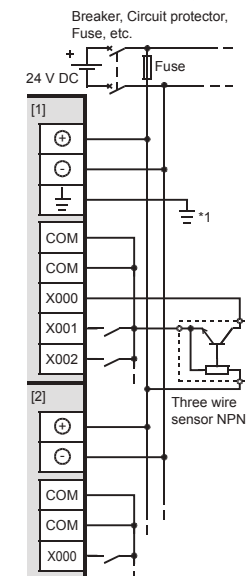

*1 Class D grounding
See section 3.3 for details.

[1]: FX5UC-□MT/D
[2]: FX5-C□EX/D, FX5-C32ET/D

2. Examples of input wiring (FX5UC-□MT/DSS)

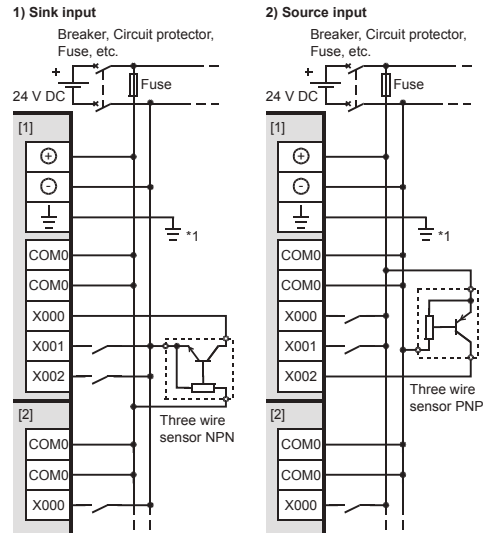

*1 Class D grounding
See section 3.3 for details.

[1]: FX5UC-□MT/DSS
[2]: FX5-C□EY/D, FX5-C32ET/DSS

3.5 Transistor output specifications and external wiring

3.5.1 Transistor output specifications

Item		Specification
Output form	FX5UC-□MT/D, FX5-C□EY/D, FX5-C32ET/D	Transistor (Sink)
	FX5UC-□MT/DSS, FX5-C□EY/DSS, FX5-C32ET/DSS	Transistor (Source)
External power supply		5 to 30 V DC
Max. load	CPU module	Y000 to Y003: 0.3 A/point Y004 or more: 0.1 A/point
	FX5-C□EY/D(SS), FX5-C32ET/D(SS)	0.1 A/point
		Make sure that the total load current of 8 load points is 0.8 A* ¹ or less.
Open circuit leakage current		0.1 mA or less/30 V DC
ON voltage	CPU module	Y000 to Y003: 1.0 V or less Y004 or more: 1.5 V or less
	I/O module	1.5 V or less
Response time	CPU module	Y000 to Y003: 2.5 μs or less/10 mA or more (5 to 24 V DC) Y004 or more: 0.2 ms or less/100 mA (at 24 V DC)
	I/O module	0.2 ms or less/100 mA (at 24 V DC)
Output operation display		LED on panel turns on when output. (DISP switch OUT side.)

*1 When two COM□ (or +V□) terminals are connected outside the CPU module, resistance load is 1.6 A or less.
Where □ indicates: 0, 1, or 2
As for the number of outputs per common terminal, refer to the following manual.
→ Refer to MELSEC IQ-F FX5UC User's Manual (Hardware).

3.5.2 External wiring of transistor output

1. External wiring of sink output type

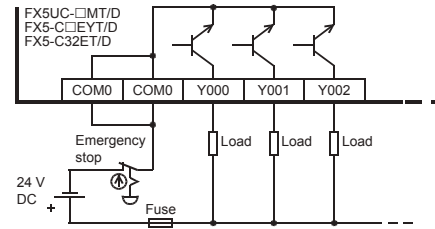

2. External wiring of source output type

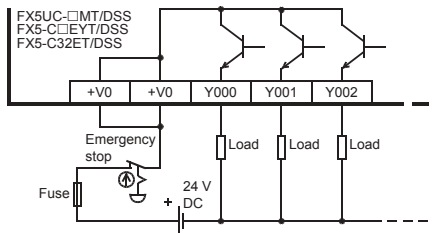

3.6 Built-in Ethernet communication specifications and external wiring

As for the details on the built-in Ethernet communication specifications and external wiring, refer to the following manual.
→ Refer to MELSEC IQ-F FX5 User's Manual (Ethernet Communication).

3.6.1 Communication specification

Item	Specification
Data transmission speed	100/10 Mbps
Communication mode	Full-duplex (FDX)/Half-duplex (HDx)* ¹
Interface	RJ45 connector
Transmission method	Base band
Maximum segment length (The distance between hub and node)	100 m
Cascade connection	100BASE-TX
	10BASE-T
Protocol type	MELSOFT connection, SLMP (3E frames), Socket communication, Predefined protocol support
Number of simultaneously open connections allowed	Total of 8 for Socket communication, MELSOFT connection, SLMP, and Predefined protocol support
Hub* ¹	Hubs with 100BASE-TX or 10BASE-T ports can be used.
Insulation method	Pulse transformer
IP address	Initial value: 192.168.3.250

*1 IEEE802.3x flow control is not supported.
*2 The value indicates the number of connectable stages when a repeater hub is used.
Contact the manufacturer of the switching hub for the number of connectable stages when using a switching hub.

3.6.2 Wiring

For the wiring, refer to the following manual.
→ Refer to MELSEC IQ-F FX5 User's Manual (Ethernet Communication).

3.6.3 Pin Configuration

The connector of the built-in Ethernet communication are arranged as follows:

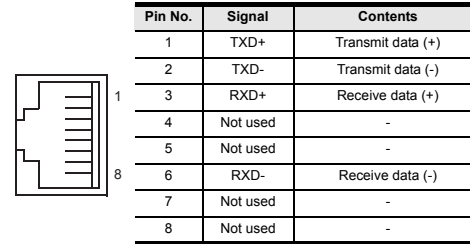

Applicable cable

10BASE-T	Cable conforming to Ethernet standard practice: Category 3 or higher (STP cable)
100BASE-TX	Cable conforming to Ethernet standard practice: Category 5 or higher (STP cable)

A straight cable is used. A cross cable can also be used when using direct connection between a personal computer and the FX5UC CPU module.

3.7 Built-in RS-485 communication specifications and external wiring

3.7.1 Communication specification

Item	Specification
Transmission standard	In conformance to RS-485/RS-422
Data transmission speed	Max. 115.2 kbps
Communication method	Full-duplex/Half-duplex
Maximum total extension distance	50 m
Protocol type	MELSOFT connection, MELSEC Communication protocol (3C/4C frames), Non-protocol communication, MODBUS RTU, Inverter communication, N:N network, Predefined protocol support
Insulation method	No insulation between the PLC.
Terminal resistors	Built-in (OPEN/110 Ω/330 Ω)
Connection method	European terminal block

3.7.2 Wiring

For the wiring, refer to the following manual.
→ Refer to MELSEC IQ-F FX5 User's Manual (Serial Communication).
→ Refer to MELSEC IQ-F FX5 User's Manual (MODBUS Communication).

3.7.3 Terminal block layouts

The terminals of the built-in RS-485 communication are arranged as follows:

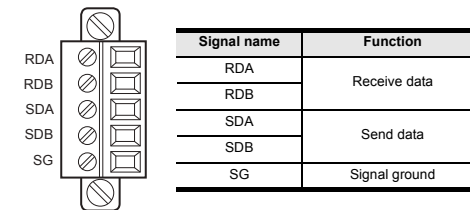

4. Terminal arrangement

For details on the terminal arrangement, refer to the following manual.
→ Refer to MELSEC IQ-F FX5UC User's Manual (Hardware).

This manual confers no industrial property rights or any rights of any other kind, nor does it confer any patent licenses. Mitsubishi Electric Corporation cannot be held responsible for any problems involving industrial property rights which may occur as a result of using the contents noted in this manual.

Warranty

Exclusion of loss in opportunity and secondary loss from warranty liability
Regardless of the gratis warranty term, Mitsubishi shall not be liable for compensation to:
(1) Damages caused by any cause found not to be the responsibility of Mitsubishi.
(2) Loss in opportunity, lost profits incurred to the user by Failures of Mitsubishi products.
(3) Special damages and secondary damages whether foreseeable or not, compensation for accidents, and compensation for damages to products other than Mitsubishi products.
(4) Replacement by the user, maintenance of on-site equipment, start-up test run and other tasks.

For safe use

- This product has been manufactured as a general-purpose part for general industries, and has not been designed or manufactured to be incorporated in a device or system used in purposes related to human life.
- Before using the product for special purposes such as nuclear power, electric power, aerospace, medicine or passenger movement vehicles, consult with Mitsubishi Electric.
- This product has been manufactured under strict quality control. However when installing the product where major accidents or losses could occur if the product fails, install appropriate backup or failsafe functions in the system.