

Industrial automation

Elincom Group

 European Union: www.elinco.eu

 Russia: www.elinc.ru

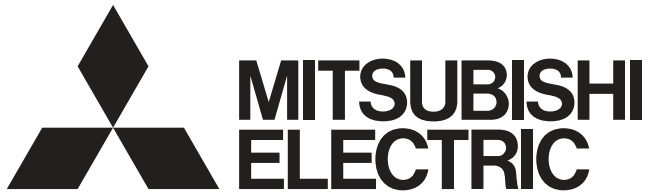

PROGRAMMABLE CONTROLLERS

MELSEC iQ-F
series



MELSEC iQ-F



FX5 User's Manual (Ethernet Communication)

SAFETY PRECAUTIONS

(Read these precautions before use.)

Before using this product, please read this manual and the relevant manuals introduced in this manual carefully and pay full attention to safety in order to handle the product correctly.

This manual classifies the safety precautions into two categories: [ WARNING] and [ CAUTION].

 WARNING	Indicates that incorrect handling may cause hazardous conditions, resulting in death or severe injury.
 CAUTION	Indicates that incorrect handling may cause hazardous conditions, resulting in minor or moderate injury or property damage.

Depending on the circumstances, procedures indicated by [ CAUTION] may also cause severe injury.

It is important to follow all precautions for personal safety.

Store this manual in a safe place so that it can be read whenever necessary. Always forward it to the end user.

[DESIGN PRECAUTIONS]

WARNING

- Make sure to set up the following safety circuits outside the PLC to ensure safe system operation even during external power supply problems or PLC failure. Otherwise, malfunctions may cause serious accidents.
 - (1) Note that when the CPU module detects an error, such as a watchdog timer error, during self-diagnosis, all outputs are turned off. Also, when an error that cannot be detected by the CPU module occurs in an input/output control block, output control may be disabled. External circuits and mechanisms should be designed to ensure safe machinery operation in such a case.
- Construct an interlock circuit in the program so that the whole system always operates on the safe side before executing the control (for data change) of the PLC in operation. Read the manual thoroughly and ensure complete safety before executing other controls (for program change, parameter change, forcible output and operation status change) of the PLC in operation. Otherwise, the machine may be damaged and accidents may occur due to erroneous operations.
- For the operating status of each station after a communication failure of the network, refer to relevant manuals for the network. Incorrect output or malfunction may result in an accident.
- When executing control (data change) to a running other station programmable controller by connecting the external device to the SLMP compatible device, configure interlock circuits in the program of the other station programmable controller to ensure that the entire system operates safely at any times.

For other controls to a running other station programmable controller (such as program modification or operating status change), read relevant manuals carefully and ensure the safety before the operation. Especially, in the case of a control from an external device to a remote other station programmable controller, immediate action cannot be taken for a problem on the programmable controller due to communication failure. Determine the handling method as a system when communication failure occurs along with configuration of interlock circuit on other station PLC program, by considering external equipment and other station PLC.

- Do not write any data into the "system area" or "write protect area" of the buffer memory in the SLMP compatible device or intelligent function module. Also, do not output (ON) any "use prohibited" signals among the signals which are output to the SLMP compatible device and intelligent function device. Executing data writing to the "system area" or "write protect area", or outputting "use prohibited" signals may cause malfunction of the programmable controller alarm.
- To maintain the safety of the programmable controller system against unauthorized access from external devices via the network, take appropriate measures. To maintain the safety against unauthorized access via the Internet, take measures such as installing a firewall.

[WIRING PRECAUTIONS]

WARNING

- Make sure to cut off all phases of the power supply externally before attempting installation or wiring work. Failure to do so may cause electric shock or damage to the product.
 - Make sure to attach the terminal cover, provided as an accessory, before turning on the power or initiating operation after installation or wiring work. Failure to do so may cause electric shock.
-

[WIRING PRECAUTIONS]

CAUTION

- Install module so that excessive force will not be applied to terminal blocks, power connectors, I/O connectors, communication connectors, or communication cables. Failure to do so may result in wire damage/breakage or PLC failure.
 - Do not bundle the power line, control line and communication cables together with or lay them close to the main circuit, high-voltage line, load line or power line. As a guideline, lay the power line, control line and communication cables at least 100 mm away from the main circuit, high-voltage line, load line or power line.
-

[STARTUP AND MAINTENANCE PRECAUTIONS]

WARNING

- Do not touch any terminal while the PLC's power is on. Doing so may cause electric shock or malfunctions.
 - Before cleaning or retightening terminals, cut off all phases of the power supply externally. Failure to do so in the power ON status may cause electric shock.
 - Before modifying the program in operation, forcible output, running or stopping the PLC, read through this manual carefully, and ensure complete safety. An operation error may damage the machinery or cause accidents.
-

[STARTUP AND MAINTENANCE PRECAUTIONS]

CAUTION

- Do not disassemble or modify the PLC. Doing so may cause fire, equipment failures, or malfunctions. For repair, contact your local Mitsubishi Electric representative.
 - Turn off the power to the PLC before attaching or detaching the following devices. Failure to do so may cause equipment failures or malfunctions.
 - Peripheral devices, expansion board, expansion adapter, and connector conversion adapter
 - Extension modules and bus conversion module
 - Battery
 - Read relevant manuals carefully and ensure the safety before performing online operations (operation status change) with peripheral devices connected to the running SLMP compatible device or CPU modules of other stations. Improper operation may damage machines or cause accidents.
-

INTRODUCTION

This manual contains text, diagrams and explanations which will guide the reader in the correct installation, safe use and operation of the FX5 Built-in Ethernet function.

It should be read and understood before attempting to install or use the unit. Store this manual in a safe place so that you can read it whenever necessary.

Always forward it to the end user.

Regarding use of this product

- This product has been manufactured as a general-purpose part for general industries, and has not been designed or manufactured to be incorporated in a device or system used in purposes related to human life.
- Before using the product for special purposes such as nuclear power, electric power, aerospace, medicine or passenger movement vehicles, consult Mitsubishi Electric.
- This product has been manufactured under strict quality control. However when installing the product where major accidents or losses could occur if the product fails, install appropriate backup or failsafe functions in the system.

Note

- If in doubt at any stage during the installation of the product, always consult a professional electrical engineer who is qualified and trained in the local and national standards. If in doubt about the operation or use, please consult the nearest Mitsubishi Electric representative.
- Mitsubishi Electric will not accept responsibility for actual use of the product based on these illustrative examples.
- This manual content, specification etc. may be changed, without a notice, for improvement.
- The information in this manual has been carefully checked and is believed to be accurate; however, if you notice a doubtful point, an error, etc., please contact the nearest Mitsubishi Electric representative. When doing so, please provide the manual number given at the end of this manual.

MEMO

CONTENTS

SAFETY PRECAUTIONS	1
INTRODUCTION	4
RELEVANT MANUALS	8
TERMS	9
CHAPTER 1 OUTLINE	11
CHAPTER 2 SPECIFICATIONS	12
2.1 Communication Specifications	12
2.2 Connection specifications	13
CHAPTER 3 LIST OF FUNCTIONS	14
CHAPTER 4 CONNECTION WITH MELSOFT PRODUCT AND GOT	16
4.1 Direct Connection with Engineering Tool	16
Setting method	17
Precautions	18
4.2 Connection via a hub	19
Setting the CPU Module	20
Engineering Tool Settings	21
Searching CPU Modules on Network	22
Communication via Router	24
Precautions	25
CHAPTER 5 SLMP FUNCTION	27
5.1 Specifications	28
Communication specifications	28
Link specifications	29
5.2 Setting Method	30
5.3 SLMP Commands	31
Command list	31
Applicable devices	35
5.4 Precautions	37
CHAPTER 6 PREDEFINED PROTOCOL SUPPORT FUNCTION	39
6.1 Data Communication	40
6.2 Protocol Communication Type	45
6.3 Packet Elements	46
6.4 Execution Conditions of Predefined Protocol Communications	51
6.5 Example of Predefined Protocol Communications	52
6.6 Predefined Protocol Support Function Instruction	58
Executing the registered protocols	58
CHAPTER 7 SOCKET COMMUNICATION FUNCTION	64
7.1 Communication Using TCP	65
7.2 Communication Using UDP	72
7.3 Precautions	74
7.4 Socket Communication Function Instructions	76

Opening a connection	77
Disconnecting a connection	81
Reading received data in the END processing	84
Sending data	87
Reading connection information	90
Reading socket communication receive data	92
CHAPTER 8 REMOTE PASSWORD	94
8.1 Communication Using Remote Password	94
8.2 Remote Password Setting	95
8.3 Precautions	97
8.4 Detection of Unauthorized Access and Actions	98
CHAPTER 9 IP ADDRESS CHANGE FUNCTION	99
9.1 Overview of the IP address change function	99
9.2 IP address to be set for the CPU module	100
9.3 Write operation to IP address storage area	101
IP address storage area write procedure	101
9.4 Clear operation to IP address storage area	102
IP address storage area clear procedure	102
9.5 Precautions	103
CHAPTER 10 TROUBLESHOOTING	104
10.1 Checking Errors by LEDs	104
Error display check	104
Error information read/clear method	105
10.2 Checking Errors by GX Works3	105
Ethernet diagnostics	105
10.3 Error Codes	110
Error codes of the IP address change function	110
Error codes of the Ethernet communication	110
SLMP function error code	112
10.4 Troubleshooting Flowchart	113
Errors during SLMP communication	114
APPENDIX	116
Appendix 1 List of Special Device Applications and Assignments	116
INDEX	127
REVISIONS	128
WARRANTY	129
TRADEMARKS	130

RELEVANT MANUALS

Manual name <manual number>	Description
MELSEC iQ-F FX5 User's Manual(Startup) <JY997D58201>	Performance specifications, procedures before operation, and troubleshooting of the CPU module.
MELSEC iQ-F FX5U User's Manual(Hardware) <JY997D55301>	Describes the details of hardware of the FX5U CPU module, including input/output specifications, wiring, installation, and maintenance.
MELSEC iQ-F FX5UC User's Manual(Hardware) <JY997D61401>	Describes the details of hardware of the FX5UC CPU module, including input/output specifications, wiring, installation, and maintenance.
MELSEC iQ-F FX5 User's Manual(Application) <JY997D55401>	Describes basic knowledge required for program design, functions of the CPU module, devices/labels, and parameters.
MELSEC iQ-F FX5 Programming Manual(Program Design) <JY997D55701>	Describes specifications of ladders, ST, FBD/LD, and other programs and labels.
MELSEC iQ-F FX5 Programming Manual(Instructions, Standard Functions/Function Blocks) <JY997D55801>	Describes specifications of instructions and functions that can be used in programs.
MELSEC iQ-F FX5 User's Manual(Serial Communication) <JY997D55901>	Describes N:N network, MELSEC Communication protocol, inverter communication, non-protocol communication, and predefined protocol support.
MELSEC iQ-F FX5 User's Manual(MELSEC Communication Protocol) <JY997D60801>	Explains methods for the device that is communicating with the CPU module by MC protocol to read and write the data of the CPU module.
MELSEC iQ-F FX5 User's Manual(MODBUS Communication) <JY997D56101>	Describes MODBUS serial communication.
MELSEC iQ-F FX5 User's Manual(Ethernet Communication) <JY997D56201> (This manual)	Describes the functions of the built-in Ethernet port communication function.
MELSEC iQ-F FX5 User's Manual(SLMP) <JY997D56001>	Explains methods for the device that is communicating with the CPU module by SLMP to read and write the data of the CPU module.
MELSEC iQ-F FX5 User's Manual(CC-Link IE) <JY997D64201>	Describes the functions of the CC-Link IE field network.
MELSEC iQ-F FX5 User's Manual(Positioning Control) <JY997D56301>	Describes the positioning function.
MELSEC iQ-F FX5 User's Manual(Analog Control) <JY997D60501>	Describes the analog function.
GX Works3 Operating Manual <SH-081215ENG>	System configuration, parameter settings, and online operations of GX Works3.

TERMS

Unless otherwise specified, this manual uses the following terms.

- □ indicates a variable part to collectively call multiple models or versions.

(Example) FX5U-32MR/ES, FX5U-32MT/ES ⇒ FX5U-32M□/ES

- For details on the FX3 devices that can be connected with the FX5, refer to the User's Manual(Hardware) of the CPU module used.

Terms	Description
■Devices	
FX5	Generic term for FX5U and FX5UC PLCs
FX3	Generic term for FX3S, FX3G, FX3GC, FX3U, and FX3UC PLCs
FX5 CPU module	Generic term for FX5U CPU module and FX5UC CPU module
FX5U CPU module	Generic term for FX5U-32MR/ES, FX5U-32MT/ES, FX5U-32MT/ESS, FX5U-64MR/ES, FX5U-64MT/ES, FX5U-64MT/ESS, FX5U-80MR/ES, FX5U-80MT/ES, FX5U-80MT/ESS, FX5U-32MR/DS, FX5U-32MT/DS, and FX5U-32MT/DSS
FX5UC CPU module	Generic term for FX5UC-32MT/D, FX5UC-32MT/DSS, FX5UC-64MT/D, FX5UC-64MT/DSS, FX5UC-96MT/D, and FX5UC-96MT/DSS
Extension module	Generic term for FX5 extension modules and FX3 function modules
• FX5 extension module	Generic term for I/O modules, FX5 extension power supply module, and FX5 intelligent function module
• FX3 extension module	Generic term for FX3 extension power supply module and FX3 intelligent function module
Extension module (extension cable type)	Generic term for Input modules (extension cable type), Output modules (extension cable type), Powered input/output module, High-speed pulse input/output module, Extension power supply module (extension cable type), Connector conversion module (extension cable type), Intelligent function modules, and Bus conversion module (extension cable type)
Extension module (extension connector type)	Generic term for Input modules (extension connector type), Output modules (extension connector type), Input/output modules, Extension power supply module (extension connector type), Connector conversion module (extension connector type), and Bus conversion module (extension connector type)
I/O module	Generic term for input modules, output modules, Input/output modules, powered input/output modules, and high-speed pulse input/output modules
Input module	Generic term for Input modules (extension cable type) and Input modules (extension connector type)
• Input module (extension cable type)	Generic term for FX5-8EX/ES and FX5-16EX/ES
• Input module (extension connector type)	Generic term for FX5-C16EX/D, FX5-C16EX/DS, FX5-C32EX/D, and FX5-C32EX/DS
Output module	Generic term for output modules (extension cable type) and output modules (extension connector type)
• Output module (extension cable type)	Generic term for FX5-8EYR/ES, FX5-8EYT/ES, FX5-8EYT/ESS, FX5-16EYR/ES, FX5-16EYT/ES, and FX5-16EYT/ESS
• Output module (extension connector type)	Generic term for FX5-C16EYT/D, FX5-C16EYT/DSS, FX5-C32EYT/D, and FX5-C32EYT/DSS
Input/output module	Generic term for FX5-C32ET/D and FX5-C32ET/DSS
Powered input/output module	Generic term for FX5-32ER/ES, FX5-32ET/ES, FX5-32ET/ESS, FX5-32ER/DS, FX5-32ET/DS, and FX5-32ET/DSS
High-speed pulse input/output module	Generic term for FX5-16ET/ES-H and FX5-16ET/ESS-H
Extension power supply module	Generic term for FX5 extension power supply module (extension cable type), FX5 extension power supply module (extension connector type), and FX3 extension power supply module
• FX5 extension power supply module (extension cable type)	Different name for FX5-1PSU-5V
• FX5 extension power supply module (extension connector type)	Different name for FX5-C1PS-5V
• FX3 extension power supply module	Different name for FX3U-1PSU-5V
Intelligent module	The abbreviation for intelligent function modules
Intelligent function module	Generic term for FX5 intelligent function modules and FX3 intelligent function modules
• FX5 intelligent function module	Generic term for FX5-40SSC-S and FX5-CCLIEF
• FX3 intelligent function module	Generic term for FX3U-4AD, FX3U-4DA, FX3U-4LC, FX3U-1PG, FX3U-2HC, FX3U-16CCL-M, FX3U-64CCL, and FX3U-128ASL-M
Expansion board	Generic term for board for FX5U CPU module
• Communication board	Generic term for FX5-232-BD, FX5-485-BD, and FX5-422-BD-GOT
Expansion adapter	Generic term for adapter for FX5 CPU module
• Communication adapter	Generic term for FX5-232ADP and FX5-485ADP
• Analog adapter	Generic term for FX5-4AD-ADP and FX5-4DA-ADP

Terms	Description
Bus conversion module	Generic term for Bus conversion module (extension cable type) and Bus conversion module (extension connector type)
• Bus conversion module (extension cable type)	Different name for FX5-CNV-BUS
• Bus conversion module (extension connector type)	Different name for FX5-CNV-BUSC
Connector conversion module	Generic term for Connector conversion module (extension cable type) and Connector conversion module (extension connector type)
• Connector conversion module (extension cable type)	Different name for FX5-CNV-IF
• Connector conversion module (extension connector type)	Different name for FX5-CNV-IFC
Extension cable	Generic term for FX5-30EC and FX5-65EC
Connector conversion adapter	Different name for FX5-CNV-BC
Battery	Different name for FX3U-32BL
Peripheral device	Generic term for engineering tools and GOTs
GOT	Generic term for Mitsubishi Graphic Operation Terminal GOT1000 and GOT2000 series
■Software packages	
Engineering tool	The product name of the software package for the MELSEC programmable controllers
GX Works3	The product name of the software package, SWnDND-GXW3, for the MELSEC programmable controllers (The 'n' represents a version.)
■Communication-related	
Built-in RS-485 port	Built-in RS-485 port of the CPU module.
Serial port	Generic term for the four ports consisting of the FX5 built-in RS-485 port (CH1), communication board (CH2), communication adapter 1 (CH3), and communication adapter 2 (CH4).
SLMP	The abbreviation for Seamless Message Protocol. A protocol for accessing SLMP-compatible devices and PLCs that are connected to SLMP-compatible devices from external devices.
SLMP-compatible device	Generic term for devices that can receive SLMP messages.
MC protocol	The abbreviation of the MELSEC communication protocol. A protocol for accessing MC protocol-compatible devices and PLCs that are connected to MC protocol-compatible devices from external devices.
MC protocol-compatible device	Generic term for devices that can receive MC protocol messages.
External device	A generic term for personal computers connected by Ethernet for data communication and other Ethernet-equipped modules.
Relay station	A station that includes two or more network modules. Transient transmission is performed through this station to stations on other networks.
Buffer memory	Memory areas of Intelligent function modules and SLMP-compatible devices for storing setting values and monitor values.

1 OUTLINE

The following describes the built-in Ethernet function of the FX5 CPU module.

Connection with engineering tool and GOT

- The CPU module can be connected to multiple engineering tools and GOT by using hub. Up to 8 external devices can be connected one CPU module at the same time.
- CPU modules connected to the same hub as the engineering tool can be searched and the IP address of the displayed target device can be specified.
- In MELSOFT connection, access through routers in an environment such as a corporate LAN.

Direct connection with engineering tool

The CPU module can be directly connected to the engineering tool with an Ethernet cable, without using a hub. For direct connection, the IP address and host name need not be specified in the transfer setup.

Communication using SLMP

CPU module device data can be read or written from external devices such as a personal computer or GOT, enabling the CPU module operation monitoring, data analysis, and production control.

Predefined protocol support

Data can be exchanged between the external device (such as measuring instrument and bar code reader) and the CPU module following the protocol of the device.

Socket communication

The socket communication function allows data communication with the external devices on Ethernet by TCP or UDP using the socket communication instructions.

Remote password

Unauthorized access from the outside can be prevented and the security can be enhanced by setting the remote password.

IP Address Change Function

This function is provided to change the IP address of the CPU module by setting the desired IP address to special registers from a peripheral unit or another unit and turning ON a special relay.

This function changes the IP address of the CPU module even if no settings are made in GX Works3 PLC parameters.

2 SPECIFICATIONS

2.1 Communication Specifications

The following describes the communication specifications of the built-in Ethernet port of the CPU module.

Item		Specification
Transmission specifications	Data transfer speed	100/10 Mbps
	Communication mode	Full-duplex or half-duplex ^{*1}
	Interface	RJ45 connector
	Transmission method	Base band
	Maximum segment length (Maximum distance between hub and node)	100 m
	Number of cascade connections	100BASE-TX
10BASE-T		4 levels maximum ^{*3}
Protocol type		MELSOFT connection, SLMP (3E frame), Socket communication, Predefined protocol support
Number of connections		Total of 8 for socket communication, MELSOFT connection, SLMP, and Predefined protocol support. (Up to 8 external devices can access one CPU module at the same time.)
Hub ^{*1}		Hubs with 100BASE-TX or 10BASE-T ports ^{*4} can be used.
IP address		Initial value: 192.168.3.250
Connection cable ^{*2}	100BASE-TX	Ethernet cable of category 5 or higher (STP cable)
	10BASE-T	Ethernet cable of category 3 or higher (STP cable)

*1 IEEE802.3x flow control is not supported.

*2 A straight cable can be used. If a personal computer or GOT and CPU module are directly connected a cross cable can be used.

*3 This number applies when a repeater hub is used. When using a switching hub, check the number of cascaded stages with the manufacturer of the hub to be used.

*4 The ports must comply with the IEEE802.3 100BASE-TX or IEEE802.3 10BASE-T standards.

Point

- When connected to a hub, the CPU module determines the cable used (100BASE-TX or 10BASE-T) and the communication mode (full-duplex or half-duplex) according to the hub. Set the hub into the half-duplex mode if the hub that does not have the auto-negotiation function.
- If broadcast storm occurs in the network, scan time may be increased.
- If the destination device of the CPU module does not respond due to power off or other reasons, Ethernet communication of the CPU module may get delayed by up to 500 ms.

Precautions

The operation of the following connections is not guaranteed. Check the operation before using the module.

- Connection using internet (general public line) (Internet-access service offered by an Internet service provider or a telecommunications carrier)
- Connection using firewall device(s)
- Connection using broadband router(s)
- Connection using wireless LAN

Remark:

TCP and UDP are defined as follows:

- TCP (Transmission Control Protocol): In communications among programmable controllers and networked devices, this protocol establishes a connection between port numbers of the two devices to perform reliable data communications.
- UDP (User Datagram Protocol): This is a connectionless protocol and thereby its speed is faster than that of TCP, but less reliable. (Data may be lost or not be received in correct order.)

Select an appropriate protocol, considering the specifications of the external device and the characteristics of the above protocols.

2.2 Connection specifications

Ethernet cable

Use one of the cables listed below for the Ethernet cable (100BASE-TX/10BASE-T cable) to connect to the built-in Ethernet port.

Item	Specifications
When using 100BASE-TX	Ethernet cable: Category 5 or higher (STP cable ^{*1})
When using 10BASE-T	Ethernet cable: Category 3 or higher (STP cable ^{*1})

*1 Shielded twisted pair cable.

A straight cable can be used. A cross cable can also be used when using direct connection between the personal computer and the built-in Ethernet.

Ethernet cable connection

This section describes how to connect the built-in Ethernet to a 100BASE-TX/10BASE-T network.

<Connection procedure>

1. Connect the Ethernet cable to a hub.
 2. Connect the Ethernet cable to the built-in Ethernet.
- The following shows the Ethernet cable connection diagram.

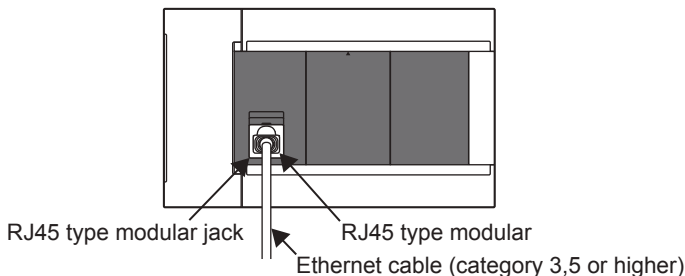

Point

- When connected to a hub, the CPU module determines the cable used (100BASE-TX or 10BASE-T) and the communication mode (full-duplex or half-duplex) according to the hub (Auto-negotiation function). Set the hub to the half-duplex mode if the hub that does not support the auto-negotiation function.
- When the ground terminal of the CPU module cannot be grounded, the communication line may be closed due to the effects of noise, making it impossible to communicate with other devices.

3 LIST OF FUNCTIONS

The following table shows the list of functions of the built-in Ethernet of the CPU module.

Function	Outline of system	Reference
Direct connection with MELSOFT	Built-in Ethernet of CPU module and MELSOFT product (GX Works3, etc.) are connected by single Ethernet cable without using a hub. Communication is done by simply specifying the connection destination; you don't have to set the IP address.	Page 16 Direct Connection with Engineering Tool
MELSOFT connection	Communication with MELSOFT products (GX Works3, etc.) is done within LAN such as company internal LAN.	Page 19 Connection via a hub
Connected CPU search function	Searches for built-in Ethernet (CPU module) connected with personal computer using GX Works3 within the same hub. Acquires IP address by selecting from search results list.	Page 22 Searching CPU Modules on Network
MELSOFT diagnosis function	Diagnoses built-in Ethernet of CPU module from GX Works3. (Ethernet diagnostics)	Page 105 Ethernet diagnostics
SLMP communication function	Reads and writes PLC data from other device.	Page 27 SLMP FUNCTION
Predefined protocol support function	When the predefined protocol support function is used, data can be exchanged with the external device.	Page 39 PREDEFINED PROTOCOL SUPPORT FUNCTION
Socket communication function	By using socket communication instructions, any data can be transferred from and to the external devices connected through Ethernet using TCP or UDP.	Page 64 SOCKET COMMUNICATION FUNCTION
Remote password	Remote password setting can prevent unauthorized access from the outside and enhance the security of the system.	Page 94 REMOTE PASSWORD
IP address change function	This function is provided to change the IP address of the CPU module by setting the desired IP address to special registers from a peripheral unit or another unit and turning ON a special relay.	Page 99 IP ADDRESS CHANGE FUNCTION

4 CONNECTION WITH MELSOFT PRODUCT AND GOT

This chapter describes the method of communication between the CPU module and MELSOFT Product (engineering tool, MX Component, etc.) or GOT.

4.1 Direct Connection with Engineering Tool

The CPU module can be directly connected to the engineering tool (GX Works3) with an Ethernet cable, without using a hub. For direct connection, the IP address and host name need not be specified.

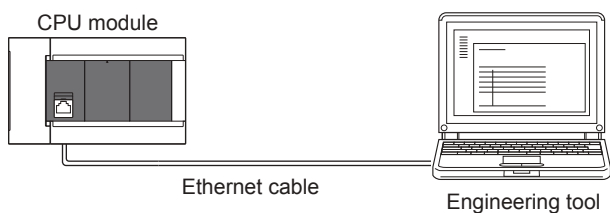

Point

An Ethernet cable used for direct connection will be longer compared with the USB cable. This can cause an unauthorized connection from a remote location.

With GX Works3, you can prevent hacking by opting to "Disable Direct Connection with MELSOFT" by Navigation window⇒[Parameter]⇒[FX5UCPU]⇒[Module Parameter]⇒[Ethernet Port]⇒[Application Settings]⇒[Security].

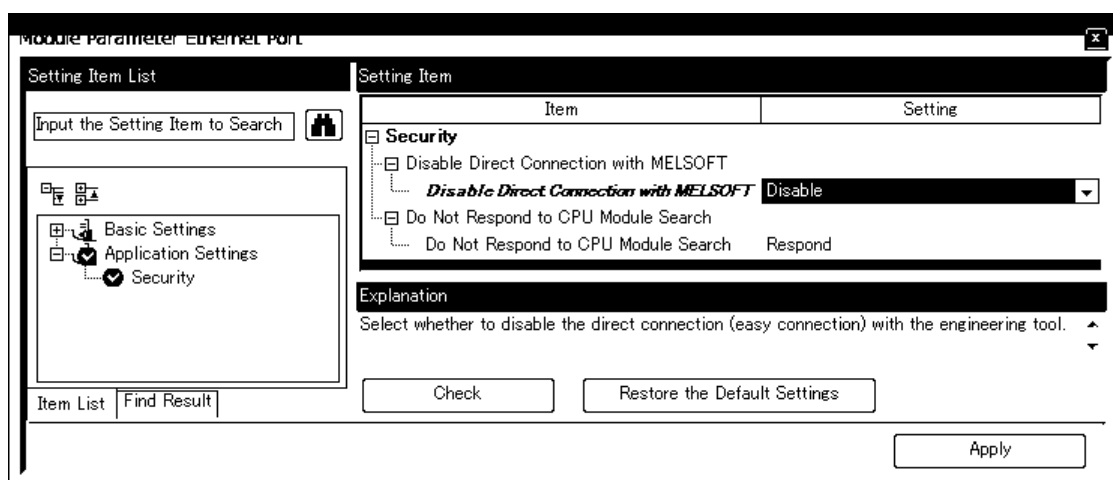

Setting method

With GX Works3, this is done using the "Specify Connection Destination Connection" screen.

Online⇒[Specify Connection Destination]

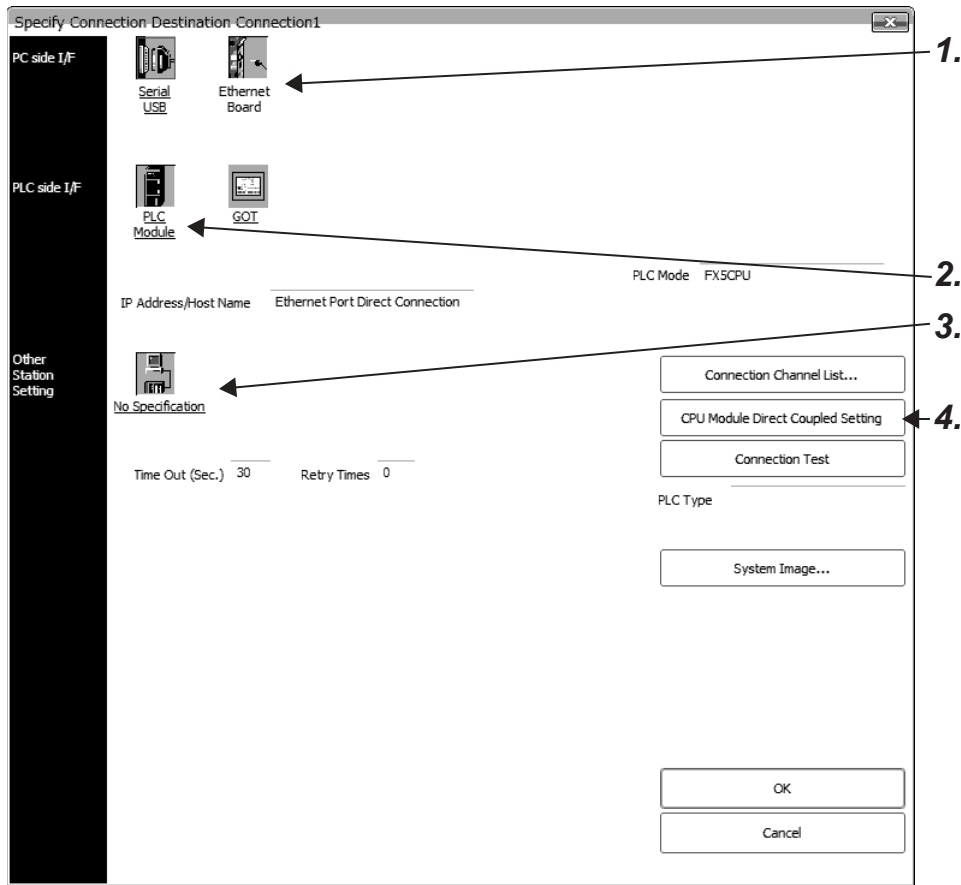

1. Select "Ethernet Board" for "PC side I/F".
2. Select "PLC Module" for "PLC side I/F".

In the "PLC side I/F Detailed Setting of PLC Module" screen, select the "Ethernet Port Direct Connection" as shown below.

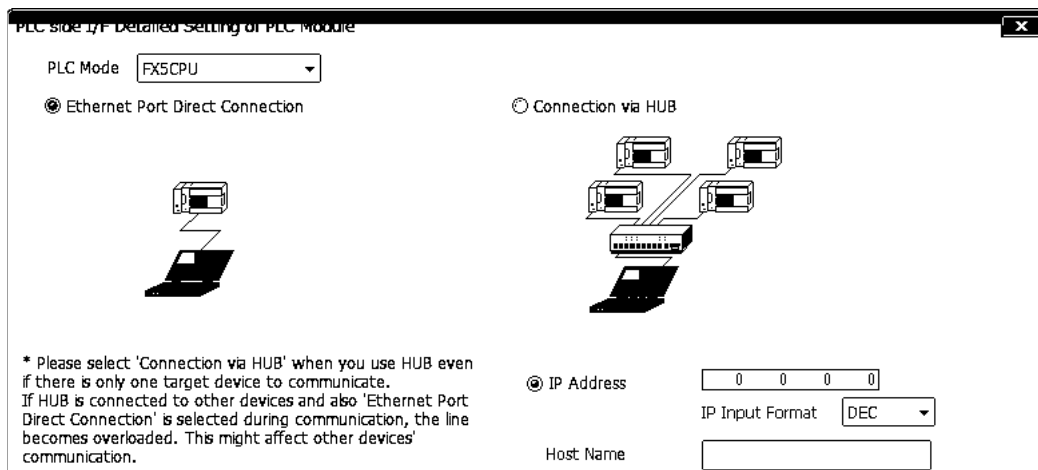

3. Set "Other Station Setting".
Select an item appropriate to the operating environment.
4. Set the Ethernet adapter of the personal computer.
Select an item appropriate to the operating environment.

Precautions

Connection to LAN line

When connecting the CPU module to a LAN line, do not set direct connection. Doing so will apply a load on the LAN line and adversely affect communications with other external devices.

Indirect connection

- When a CPU module is connected to an external device via a hub, communication cannot be performed by direct connection. (☞ Page 19 Connection via a hub)

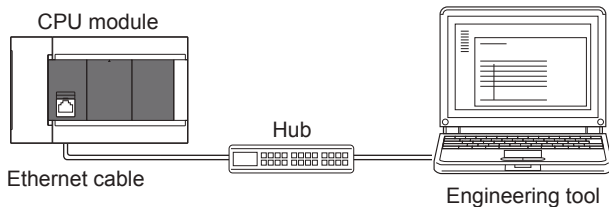

- When two or more Ethernet ports are enabled in the network connections setting on the personal computer, communication by direct connection is not possible. In the PC setting, leave only one Ethernet port enabled for direct connection and disable other Ethernet ports.

Conditions that disallow direct connection

When the following condition is met, it may not be possible to communicate directly. In such case, check the setting of the CPU module and/or personal computer.

- In the CPU module IP address bits, if the bits corresponding to "0" in the personal computer subnet mask are all ON or all OFF.

Ex.

CPU module IP address: 64.64.255.255

Personal computer IP address: 64.64.1.1

Personal computer subnet mask: 255.255.0.0

- In the CPU module IP address bits, if the bits corresponding to the host address of the class of the personal computer IP address are all ON or all OFF.

Ex.

Personal computer IP address: 192.168.0.1 ← 192.x.x.x., class C and the host address is the fourth octet.

Personal computer subnet mask: 255.0.0.0

CPU module IP address: 64.64.255.255 ← each bit turns on because of the fourth octet is 255

Point

The IP address for each class is as follows.

- Class A: 0.x.x.x to 127.x.x.x
- Class B: 128.x.x.x to 191.x.x.x
- Class C: 192.x.x.x to 223.x.x.x

The host address for each class is the portion including "0" as shown below.

- Class A: 255.0.0.0
- Class B: 255.255.0.0
- Class C: 255.255.255.0

4.2 Connection via a hub

In case of connection to Ethernet via hub, you must do CPU module settings and MELSOFT Product (engineering tool, etc.) settings or GOT settings.

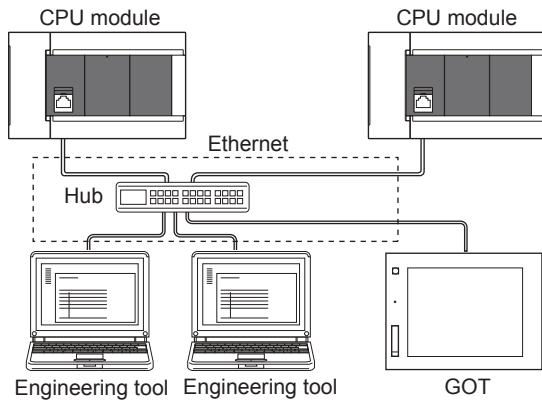

The flow up to start of Ethernet communication by the connection via a hub is as follows.

1. Setting parameters

Create unit parameters with the engineering tool. (☞ Page 20 Setting module parameters)

2. Writing to the CPU module

Turn power OFF → ON or reset the system to enable the parameters. (☞ Page 20 Writing to the CPU module)

3. Connecting cables and external devices

Connect for Ethernet communication. (☞ Page 13 Connection specifications)

4. Setting the connection destination

Set connection destination with the engineering tool. (☞ Page 21 Engineering Tool Settings)

For GOT settings, refer to the following manuals.

GOT2000 Series Connection Manual (Mitsubishi Products)

GOT1000 Series Connection Manual (Mitsubishi Products)

Setting the CPU Module

Setting module parameters

With GX Works3, this is done using the "Module parameter Ethernet Port" screen.

Navigation window⇒[Parameter]⇒[FX5UCPU]⇒[Module Parameter]⇒[Ethernet Port]⇒[Basic Settings]⇒[Own Node Settings]

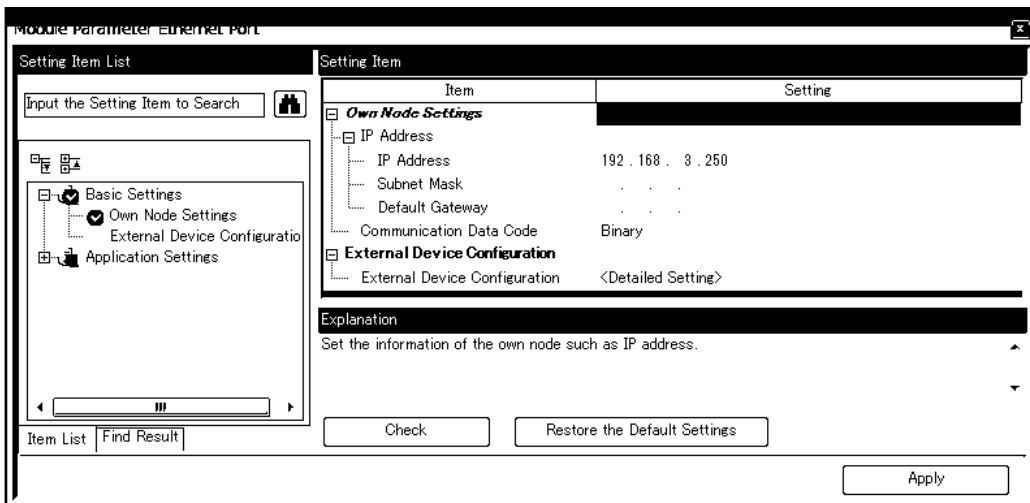

1. Set IP address of the CPU module.
2. Set MELSOFT connections.

Navigation window⇒[Parameter]⇒[FX5UCPU]⇒[Module Parameter]⇒[Ethernet Port]⇒[Basic Settings]⇒[External Device Configuration]⇒[Detailed Setting]⇒[Ethernet Configuration (Built-in Ethernet Port)] screen

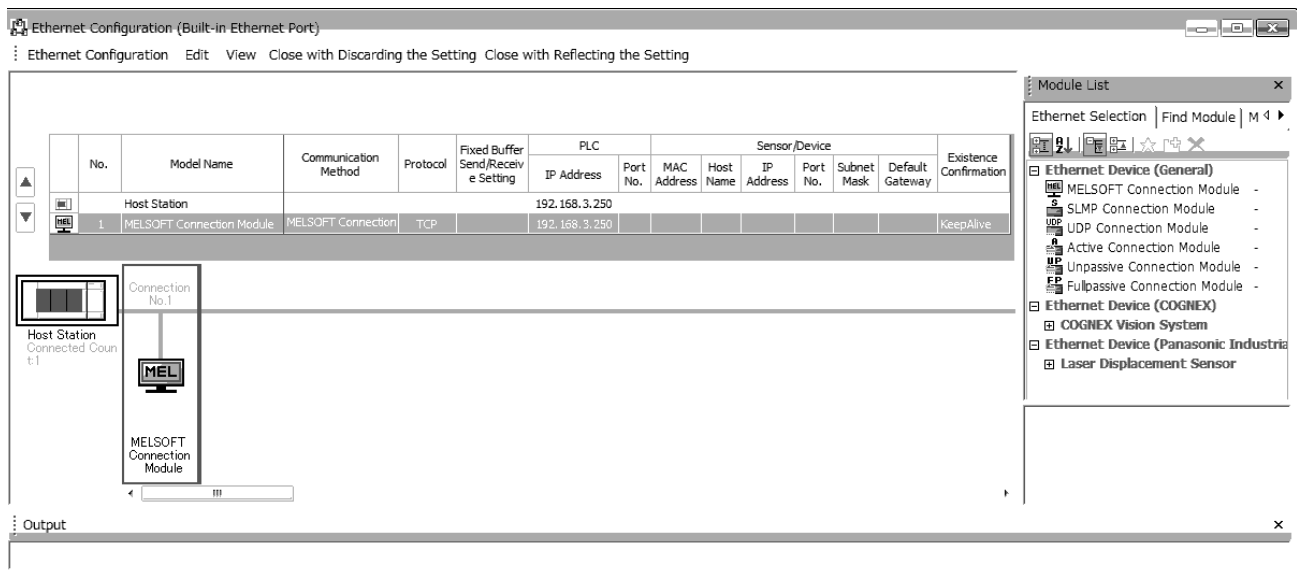

Drag and drop "MELSOFT Connection Module" from the "Module List" to the left side of the screen.

Writing to the CPU module

Write the parameters set in the CPU module.

[Online]⇒[Write to PLC]

After writing the parameters to the CPU module, power off and on or reset the CPU module to enable the parameters.

Engineering Tool Settings

With GX Works3, this is done using the "Specify Connection Destination Connection1" screen.

Online⇒[Specify Connection Destination]

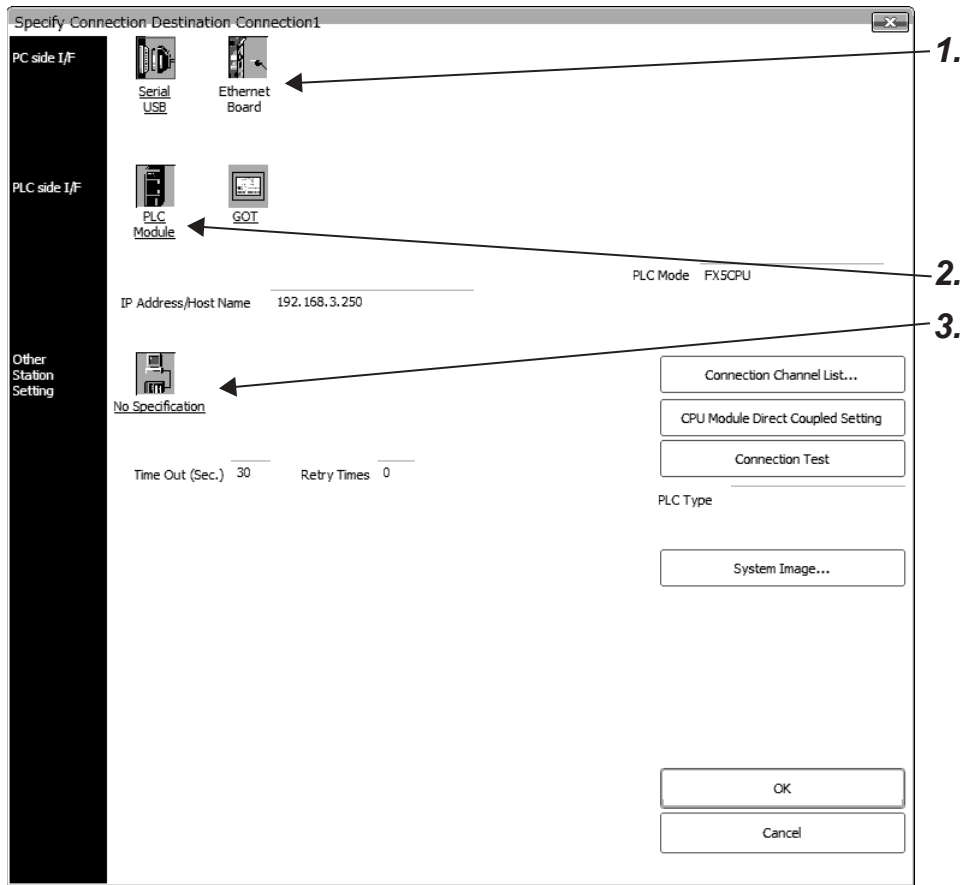

1. Select "Ethernet Board" for "PC side I/F".

2. Select "PLC Module" for "PLC side I/F".

Input the CPU IP address or host name in the "PLC side I/F Detailed Setting of PLC Module" screen as shown in the following figure.

In case of host name, set the name specified in the Microsoft® Windows® hosts file.

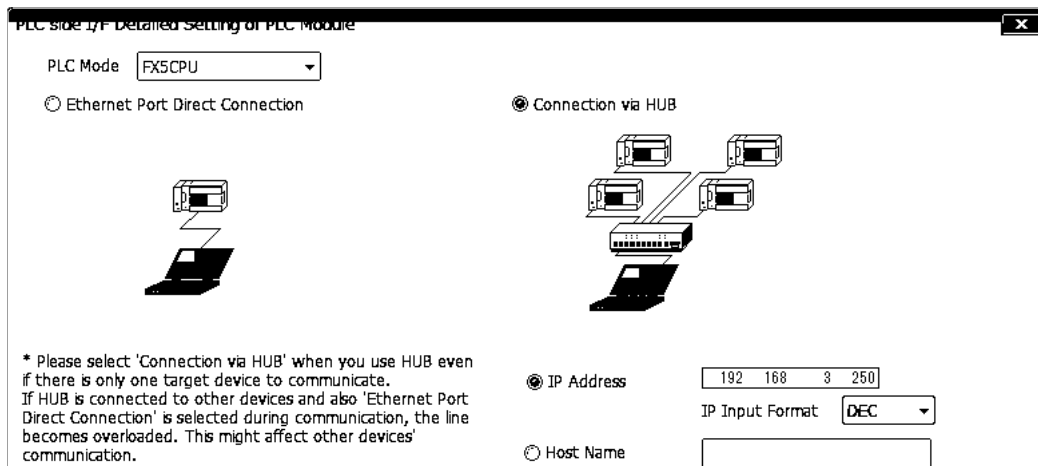

3. Set "Other Station Setting".

Select an item appropriate to the operating environment.

Searching CPU Modules on Network

In the case of GX Works3, with connections using the hub, you can search for and display of list of CPU modules connected to the same hub as personal computer (GX Works3) by clicking "Find" button from the "PLC side I/F Detailed Setting of PLC Module" screen.

PLC side I/F Detailed Setting of PLC Module

PLC Mode: FX5CPU

Ethernet Port Direct Connection

Connection via HUB

* Please select 'Connection via HUB' when you use HUB even if there is only one target device to communicate. If HUB is connected to other devices and also 'Ethernet Port Direct Connection' is selected during communication, the line becomes overloaded. This might affect other devices' communication.

IP Address: 192 168 3 250
IP Input Format: DEC

Host Name: []

Search for the FX5CPU on network.

Response Wait Time: 2 sec. Display Only CPU Type of Project(V) Find(S)

Selection IP Address Input: []

Search for FX5CPU on the same network. Unable to search for the following causes:

- No response within a specific time period.
- Connected via a router or subnet mask is different.
- 'No response to search for CPU module on network' is set in module parameter.

	IP address	CPU Type	Label	Comment
1	192.168.3.250	FX5UCPU		

OK Cancel

- CPU modules connected to cascaded hubs are also searched and a list of them is displayed.
- CPU modules connected via router cannot be searched.
- Some CPU modules connected via wireless LAN may not be found since Ethernet communication may not be stable due to packet loss.
- If multiple CPU modules with the same IP address are found in the list, check the IP address parameters for the CPU modules. Starting communication with the IP address duplicated will cause a communication error.
- Appropriate CPU modules may not be found if the service processing load is heavy. In such case, increase the response waiting time value in the "Search for the FX5CPU on network" screen, or change the service processing counts in the service processing settings of the CPU parameters.

- By selecting "Do Not Respond" in "Do Not Respond to CPU Module Search" in "Application Settings" on "Module Parameter Ethernet Port" screen, the CPU module search function can be disabled, making the system not respond to search request on the network.

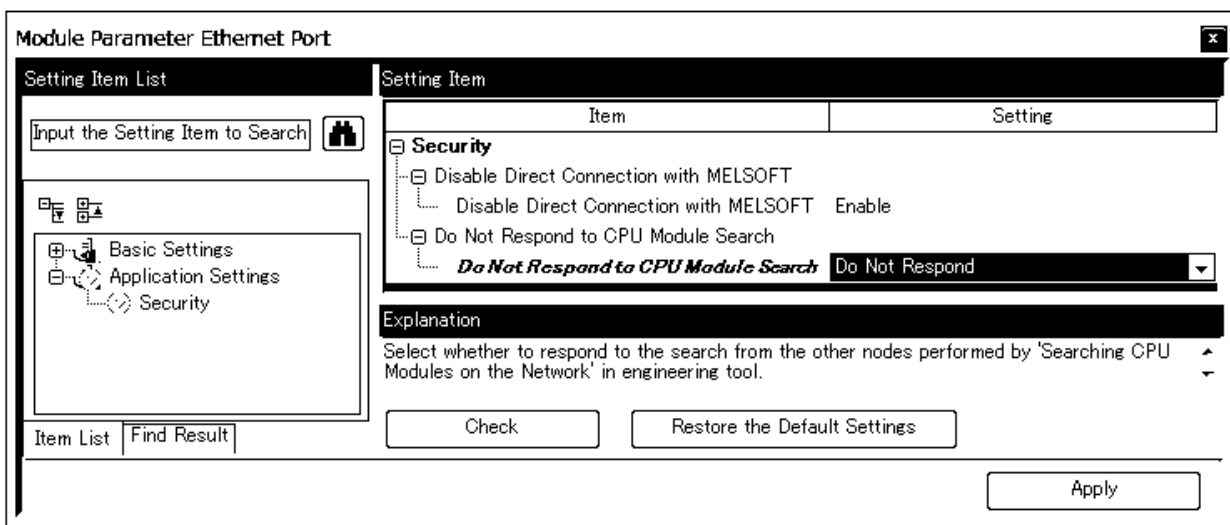

Communication via Router

Access via routers from built-in Ethernet port is available in an environment such as a corporate LAN.*1

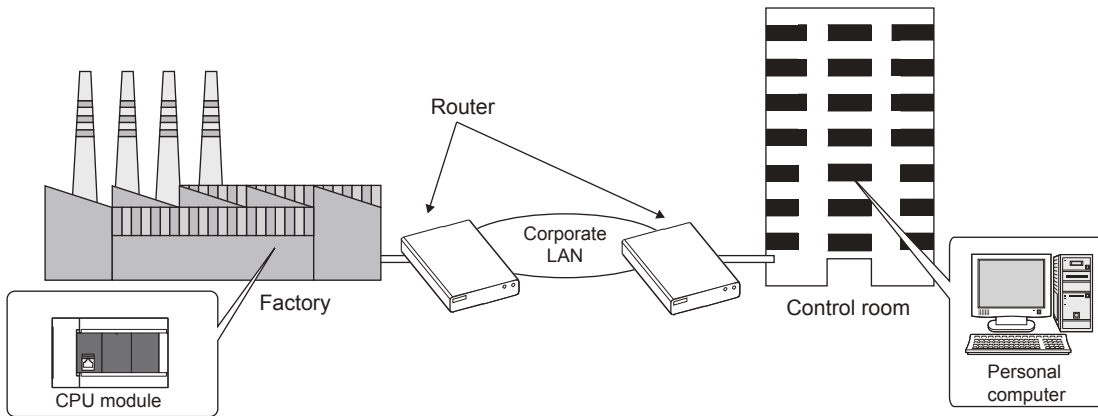

*1 Communication through routers is impossible for some functions. The following functions do not support communication via routers.
 • Searching for CPU Modules on the network

For access via router, set the subnet mask pattern and default gateway IP address in addition to IP address as per Page 20 Setting module parameters.

GX Works3:

Navigation window ⇒ [Parameter] ⇒ [FX5UCPU] ⇒ [Module Parameter] ⇒ [Ethernet Port] ⇒ [Basic Settings] ⇒ [Own Node Settings]

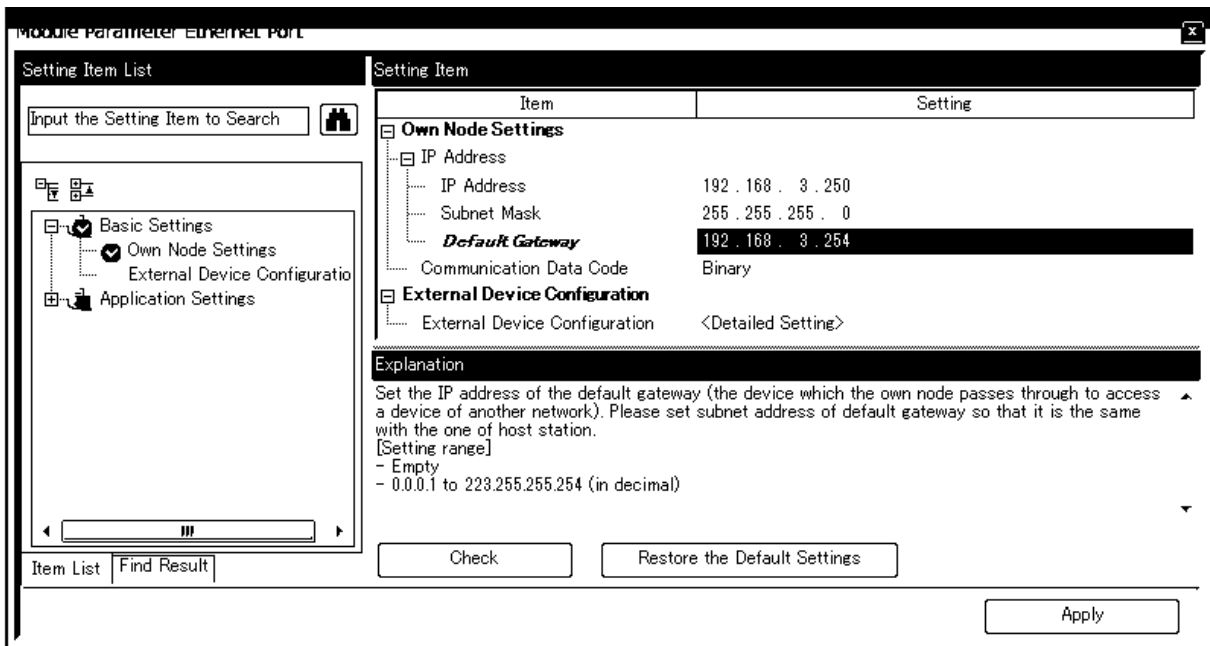

Precautions

IP address duplication

Check that the IP address is not duplicated when configuring a network or connecting a new device to a network.

If the IP address is duplicated, a device may communicate with the wrong device.

Check for IP address duplication with the connected CPU search function.

KeepAlive check

When the protocol is set to TCP, KeepAlive check is performed. (Checking for a response to a KeepAlive ACK message)

An alive check message is sent five seconds after reception of the last message from the connected device to check if the device returns a response or not. If no response is received, the alive check message will be resent at intervals of five seconds. When no response is received for 45 seconds, the connected device is regarded as non-existent and the connection is disconnected.

If the connected device does not support the TCP KeepAlive function, the connection may be disconnected.

Connections exceeding the setting

Do not exceed the number of connections set in the Ethernet configuration settings of the parameters. If the personal computer makes a number of TCP connections that exceeds the set number, the following state results depending on the application.

- Timeout error detection time gets extended.
- Unexpected timeout error occurs in any of the communicating devices.

Retransmission in case of TCP connection

If no ACK response is returned from the other end of a TCP connection, the ACK will be resent six times, starting in 0.3 seconds after the first transmission, and then 0.6, 1.2, 2.4, 4.8, and 9.6 seconds. When no TCP ACK response is returned within 19.2 seconds after the last retransmission, the device is regarded as faulty and the connection is disconnected. (As a result, the connection is disconnected in total of 38.1 seconds.)

TCP MELSOFT connection

In case of TCP communication with multiple MELSOFT devices (GX Works3, etc.), set the same number of MELSOFT devices in the unit parameters.

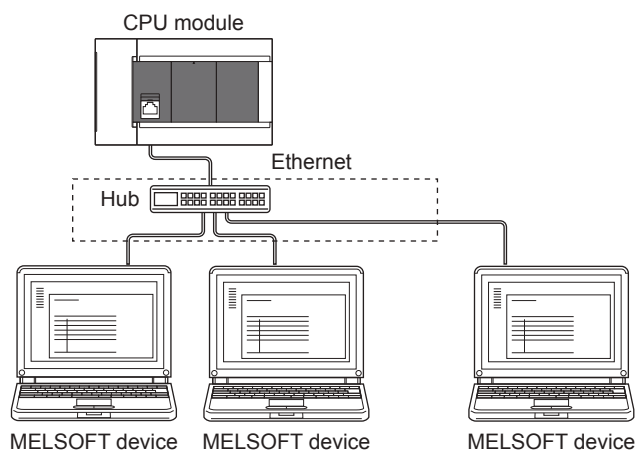

Set the same number of devices as MELSOFT devices

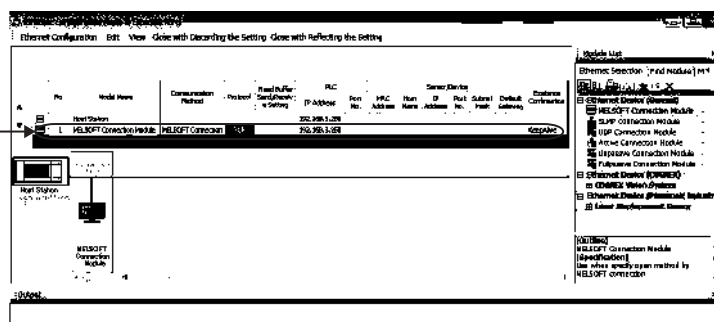

Point

When all MELSOFT devices start communicating at the same time, devices may fail to communicate because of the congestion in communication. In such a case, schedule the timing for when each device starts communicating so that the communication congestion will not occur. When using GOTs, for example, set different rise time and time-out values in the GOTs.

Remote STOP

When remote STOP is executed using the engineering tool from the built-in Ethernet port, execute remote RUN before turning OFF the power of the CPU module.

5 SLMP FUNCTION

SLMP (Seamless Message Protocol) is a protocol for accessing SLMP-compatible devices from an external device (such as personal computer or GOT) using TCP or UDP through Ethernet.

For the FX5 built-in Ethernet port, communication is possible by SLMP 3E frames.

CPU module device data can be read and written using SLMP (3E frames) from external devices.

CPU module operation monitoring, data analysis, and production control is possible from external devices by reading and writing device data.

With the remote password function, unauthorized access from the outside can be prevented. (☞ Page 94 REMOTE PASSWORD)

For details on the SLMP function, refer to the MELSEC iQ-F FX5 User's Manual(SLMP).

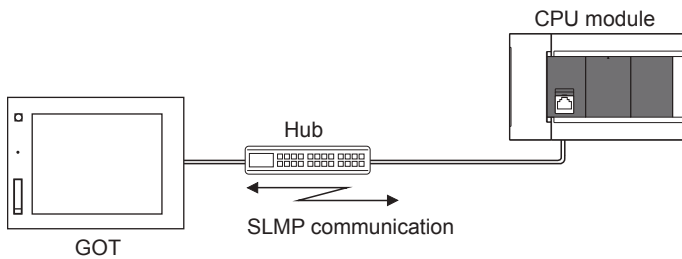

Point

SLMP 3E frames have the same message format as that of the MC protocol QnA-compatible 3E frames. External devices that have been used with the MC protocol can be connected to SLMP-compatible devices as they are.

The following shows the flow until starting communication by SLMP (3E frames).

1. Connecting cables and external devices

Make the connections for SLMP communication. (☞ Page 13 Connection specifications)

2. Setting parameters

Configure the module parameters with the engineering tool. (☞ Page 30 Setting Method)

3. Writing to the CPU module

Write the parameters set in the CPU module. Turn power OFF → ON or perform system reset to enable the parameters.

Point

Access through routers is also available. In order to configure this, set the subnet mask pattern and default gateway IP address. (☞ Page 24 Communication via Router)

5.1 Specifications

Communication specifications

Communication by the SLMP function is implemented with the following specifications, and they can be configured in module parameters in the GX Works3.

Item		Specification
Transmission specifications	Data transfer speed	100/10 Mbps
	Communication mode	Full-duplex or half-duplex ^{*1}
	Interface	RJ45 connector
	Transmission method	Base band
	Maximum segment length (Maximum distance between hub and node)	100 m
	Number of cascade connections	100BASE-TX
10BASE-T		4 levels maximum ^{*2}
Number of ports		1 port
Number of connections		8 connections maximum ^{*3}

*1 IEEE802.3x flow control is not supported.

*2 This number applies when a repeater hub is used. When using a switching hub, check the number of cascaded stages with the manufacturer of the hub to be used.

*3 Maximum of 8 connections including SLMP, MELSOFT connections, socket communication, and predefined protocol support.

Point

Hubs with 100BASE-TX or 10BASE-T ports can be connected.

A personal computer can also be directly connected without using a hub.

The ports must comply with the IEEE802.3 100BASE-TX or IEEE802.3 10BASE-T standards.

Link specifications

For applicable commands and devices, refer to  Page 31 SLMP Commands.

Link time

■3E frames

Calculate the minimum processing time for transmission by SLMP with the following formula.

However, the processing time may further increase due to the network load (line congestion), window size of connected devices, the number of simultaneously used connections, and the system configuration. Use the result of this formula as a guideline value of the processing time, when only 1 connection is being used.

- Minimum processing time for communication by SLMP (for batch read, batch write)

$Tfs = Ke + (Kdt \times Df) + Scr \times \text{number of scans required for processing} + \text{other device ACK processing time}$

Tfs: The time from when the personal computer receives the request data until the PLC finishes processing (unit: ms)^{*1}

Ke, Kdt: Constants (refer to the table below)

Df: Number of words of requested data + Number of words of response data (application data portion)

Scr: Scan time

*1 The following shows the timing from when the personal computer receives the request data until the PLC finishes processing.

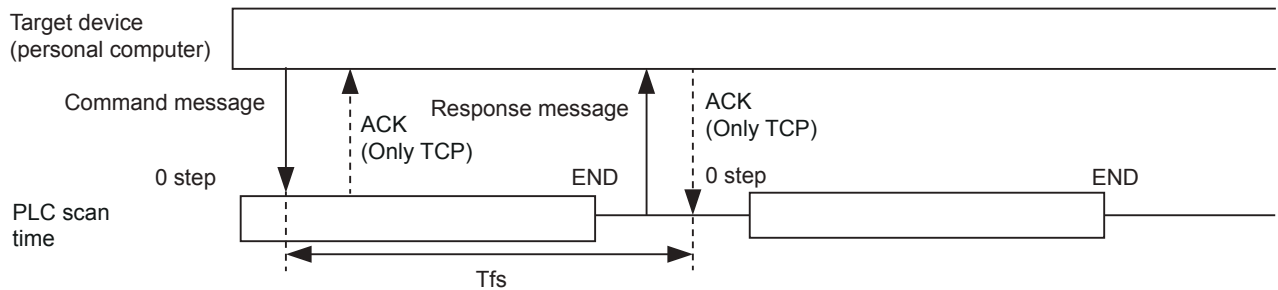

Communication content		For TCP/IP communication		For UDP/IP communication	
		Ke	Kdt	Ke	Kdt
Batch read	When communicating as ASCII code data	1	0.001	1	0.001
	When communicating as binary code data	1	0.001	1	0.001
Batch writing	When communicating as ASCII code data	1	0.001	1	0.001
	When communicating as binary code data	1	0.001	1	0.001

Ex.

[Calculation example 1]

When performing TCP/IP communication with a personal computer and reading 32 points (devices) of data from the own station's data register (D) as binary code data, using SLMP communication, the time from when the computer request data is received until processing is finished (unit: ms)

Connected station scan time is 40 ms.

$Tfs = 1 + (0.001 \times 32) + 40 \times 1 + \text{other device ACK processing time}$

[Calculation example 2]

When performing TCP/IP communication with a personal computer and writing 32 points (devices) of data to the own station's data register (D) as binary code data, using SLMP communication, the time from when the computer request data is received until processing is finished (unit: ms)

Connected station scan time is 40 ms.

$Tfs = 1 + (0.001 \times 32) + 40 \times 1 + \text{other device ACK processing time}$

5.2 Setting Method

The following shows the configuration for communication by SLMP.

Navigation window⇒[Parameter]⇒[FX5UCPU]⇒[Module Parameter]⇒[Ethernet Port]⇒[Basic Settings]⇒[Own Node Settings]

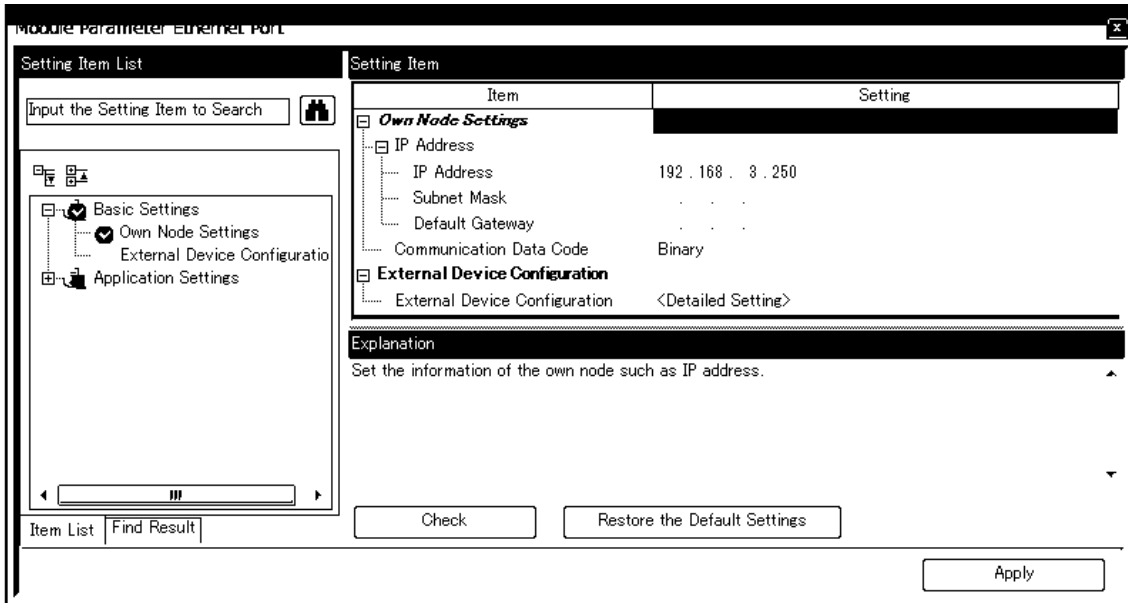

1. Under "Own Node Settings", set "IP Address" setting and "Communication Data Code".
2. Configure the connection for the SLMP connection.

Navigation window⇒[Parameter]⇒[FX5UCPU]⇒[Module Parameter]⇒[Ethernet Port]⇒[Basic Settings]⇒[External Device Configuration]⇒[Detailed Setting]⇒[Ethernet Configuration (Built-in Ethernet Port)] screen

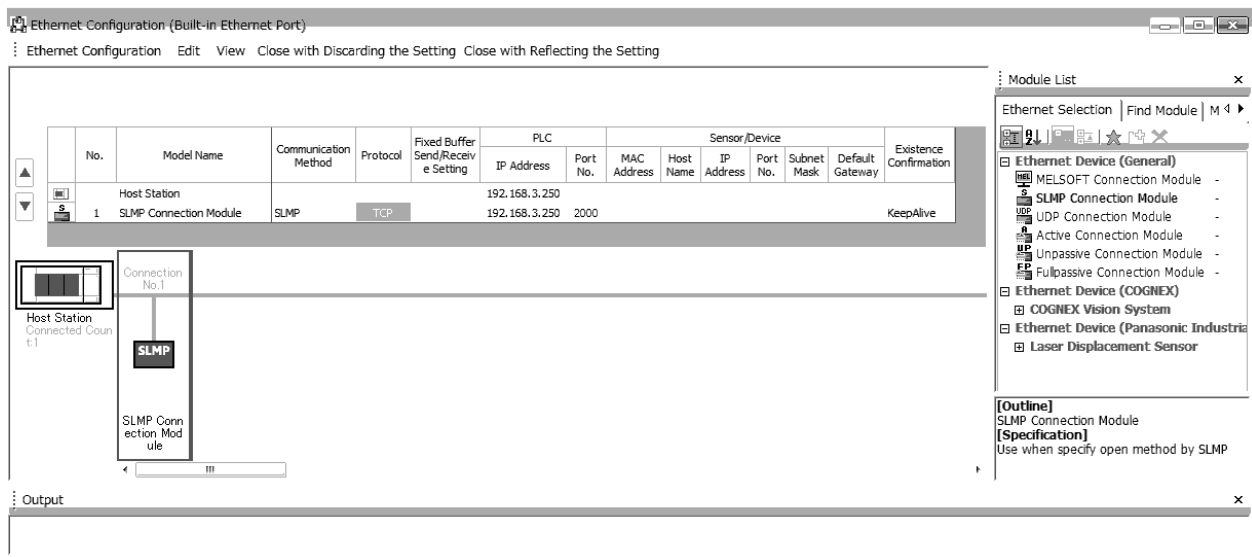

3. Drag and drop "SLMP Connection Module" under "Module List" to the left side of the screen. Select protocol (TCP or UDP) that matches the other device in "Protocol". Set the own station port number (setting range: 1025 to 4999, 5010 to 65534) for the "Port No.". Do not specify 5000 to 5009 because these ports are used by the system.

5.3 SLMP Commands

For details on the SLMP commands, refer to the MELSEC iQ-F FX5 User's Manual(SLMP).

Command list

The following commands can be executed with the SLMP function.

3E frames

Name	Command	Sub-commands	Processing content	Number of points processed per communication
Device Read (Batch)	0401H	0001H	This command reads data from a bit device or word device in units of 1 bit.	ASCII: 1792 points BIN: 3584 points
		0000H	<ul style="list-style-type: none"> This command reads data from bit devices in units of 16 bits. This command reads data from word devices in units of 1 word. 	ASCII: 480 words (7680 points) BIN: 960 words (15360 points)
		0081H	<ul style="list-style-type: none"> This command reads data from the buffer memory in intelligent function modules in units of 1 bit. This command reads data from devices indirectly specified by index registers in units of 1 bit. 	ASCII: 1792 points BIN: 3584 points
		0080H	<ul style="list-style-type: none"> This command reads data from the buffer memory in intelligent function modules in units of 1 word. This command reads data from devices indirectly specified by index registers in units of 1 word. 	ASCII: 480 words (7680 points) BIN: 960 words (15360 points)
		0083H	<ul style="list-style-type: none"> This command reads data from the buffer memory in intelligent function modules in units of 1 bit. This command reads data from devices indirectly specified by index registers in units of 1 bit. 	ASCII: 1792 points BIN: 3584 points
		0082H	<ul style="list-style-type: none"> This command reads data from the buffer memory in intelligent function modules in units of 1 word. This command reads data from devices indirectly specified by index registers in units of 1 word. 	ASCII: 480 words (7680 points) BIN: 960 words (15360 points)
Device Write (Batch)	1401H	0001H	This command writes data to bit devices in units of 1 bit.	ASCII: 1792 points BIN: 3584 points
		0000H	<ul style="list-style-type: none"> This command writes data to bit devices in units of 16 bits. This command writes data to word devices in units of 1 word. 	ASCII: 480 words (7680 points) BIN: 960 words (15360 points)
		0081H	<ul style="list-style-type: none"> This command writes data to the buffer memory in intelligent function modules and SLMP-compatible devices in units of 1 bit. Bit devices, word devices, and buffer memory are indirectly specified by index registers. 	ASCII: 1792 points BIN: 3584 points
		0080H	This command writes data to the buffer memory in intelligent function modules and SLMP-compatible devices in units of 1 word (16 bits).	ASCII: 480 words (7680 points) BIN: 960 words (15360 points)
		0083H	This command writes data to the buffer memory in intelligent function modules and SLMP-compatible devices in units of 1 bit.	ASCII: 1972 points BIN: 3584 points
		0082H	This command writes data to the buffer memory in intelligent function modules and SLMP-compatible devices in units of 1 word (16 bits).	ASCII: 480 words (7680 points) BIN: 960 words (15360 points)
Device Read Random	0403H	0000H	This command reads data from word devices in units of 1 word or 2 words by randomly specifying device numbers.	ASCII: (Word access points + double word access points) × 2 ≤ 192 BIN: Word access points + double word access points ≤ 192

Name	Command	Sub-commands	Processing content	Number of points processed per communication
Device Read Random	0403H	0080H	This command reads data from the buffer memory in intelligent function modules and SLMP-compatible devices in units of 1 word (16 bits).	ASCII: (Word access points + double word access points) × 4 ≤ 192 BIN: Word access points + double word access points ≤ 192
		0082H	This command reads data from the buffer memory in intelligent function modules and SLMP-compatible devices in units of 1 word (16 bits).	ASCII: (Word access points + double word access points) × 4 ≤ 192 BIN: Word access points + double word access points ≤ 192
Device Write Random	1402H	0001H	This command writes data to bit devices in units of 1 bit by randomly specifying device numbers.	ASCII: 94 points BIN: 188 points
		0000H	<ul style="list-style-type: none"> This command writes data to bit devices in units of 16 bits by randomly specifying device numbers. This command writes data to word devices in units of 1 word or 2 words by randomly specifying device numbers. 	ASCII: ((Word access points) × 12+ (double-word access points) × 14) × 2 ≤ 1920 BIN: (Word access points) × 12+ (double-word access points) × 14 ≤ 1920
		0081H	<ul style="list-style-type: none"> This command writes data to the buffer memory in intelligent function modules and SLMP-compatible devices in units of 1 bit. Buffer memory is indirectly specified by index registers. 	ASCII: 47 points BIN: 94 points
		0080H	This command writes data to the buffer memory in intelligent function modules and SLMP-compatible devices in units of 1 word (16 bits) or 2 words.	ASCII: ((Word access points) × 12+ (double-word access points) × 14) × 4 ≤ 1920 BIN: ((Word access points) × 12+ (double-word access points) × 14) × 2 ≤ 1920
		0083H	This command writes data to the buffer memory in intelligent function modules and SLMP-compatible devices in units of 1 bit.	ASCII: 47 points BIN: 94 points
		0082H	This command writes data to the buffer memory in intelligent function modules and SLMP-compatible devices in units of 1 word (16 bits) or 2 words.	ASCII: ((Word access points) × 12+ (double-word access points) × 14) × 4 ≤ 1920 BIN: ((Word access points) × 12+ (double-word access points) × 14) × 2 ≤ 1920
Device Read Block	0406H	0000H	With n points of bit devices and word devices as 1 block, this command reads data by randomly specifying multiple blocks. (When bit devices are specified, 1 point is 16 bits.)	ASCII: (Number of word device blocks + number of bit device blocks) × 2 ≤ 120 and (Total points of each blocks of word device + total points of each blocks of bit device) × 2 ≤ 960 BIN: Number of word device blocks + number of bit device blocks ≤ 120 and Total points of each blocks of word device + total points of each blocks of bit device ≤ 960

Name	Command	Sub-commands	Processing content	Number of points processed per communication
Device Read Block	0406H	0080H	With n points of buffer memory in intelligent function modules and SLMP-compatible devices as 1 block, this command reads data by randomly specifying multiple blocks. (When bit devices are specified, 1 point is 16 bits.)	ASCII: (Number of word device blocks + number of bit device blocks) $\times 4 \leq 120$ and (Total points of each blocks of word device + total points of each blocks of bit device) $\times 2 \leq 960$ BIN: (Number of word device blocks + number of bit device blocks) $\times 2 \leq 120$ and Total points of each blocks of word device + total points of each blocks of bit device ≤ 960
		0082H	With n points of buffer memory in intelligent function modules and SLMP-compatible devices as 1 block, this command reads data by randomly specifying multiple blocks.	ASCII: (Number of word device blocks + number of bit device blocks) $\times 4 \leq 120$ and (Total points of each blocks of word device + total points of each blocks of bit device) $\times 2 \leq 960$ BIN: (Number of word device blocks + number of bit device blocks) $\times 2 \leq 120$ and Total points of each blocks of word device + total points of each blocks of bit device ≤ 960
Device Write Block	1406H	0000H	With n points of bit devices and word devices as 1 block, this command writes data by randomly specifying multiple blocks. (When bit devices are specified, 1 point is 16 bits.)	ASCII: (Number of word device blocks + number of bit device blocks) $\times 2 \leq 120$ and ((Number of word device blocks + number of bit device blocks) $\times 4$ + Total points of each blocks of word device + total points of each blocks of bit device) $\times 2 \leq 770$ BIN: Number of word device blocks + number of bit device blocks ≤ 120 and (Number of word device blocks + number of bit device blocks) $\times 4$ + Total points of each blocks of word device + total points of each blocks of bit device ≤ 770
		0080H	With n points of buffer memory in intelligent function modules and SLMP-compatible devices as 1 block, this command writes data by randomly specifying multiple blocks. (When bit devices are specified, 1 point is 16 bits.)	ASCII: (Number of word device blocks + number of bit device blocks) $\times 4 \leq 120$ and ((Number of word device blocks + number of bit device blocks) $\times 4$ + Total points of each blocks of word device + total points of each blocks of bit device) $\times 2 \leq 770$ BIN: (Number of word device blocks + number of bit device blocks) $\times 2 \leq 120$ and (Number of word device blocks + number of bit device blocks) $\times 4$ + Total points of each blocks of word device + total points of each blocks of bit device ≤ 770

Name	Command	Sub-commands	Processing content	Number of points processed per communication
Device Write Block	1406H	0082H	With n points of buffer memory in intelligent function modules and SLMP-compatible devices as 1 block, this command writes data by randomly specifying multiple blocks.	ASCII: (Number of word device blocks + number of bit device blocks) × 4 ≤ 120 and ((Number of word device blocks + number of bit device blocks) × 4 + Total points of each blocks of word device + total points of each blocks of bit device) × 2 ≤ 770 BIN: (Number of word device blocks + number of bit device blocks) × 2 ≤ 120 and (Number of word device blocks + number of bit device blocks) × 4 + Total points of each blocks of word device + total points of each blocks of bit device ≤ 770
Remote Run	1001H	0000H	This command performs a remote RUN request for a device.	—
Remote Stop	1002H	0000H	This command performs a remote STOP request for a device.	—
Remote Pause	1003H	0000H	This command performs a remote PAUSE request for a device.	—
Remote Latch Clear	1005H	0000H	This command performs a remote latch clear request when the device is in the STOP state.	—
Remote Reset	1006H	0000H	This command performs a remote reset request to reset the device error stop state.	—
Read Type Name	0101H	0000H	This command reads the processor module name code (processor type) of a device.	—
Self-Test	0619H	0000H	This command checks if normal communication is possible.	—
Clear Error	1617H	0001H	This command batch clears all errors and turns off the LED.	—
Password Lock	1631H	0000H	This command sets to the locked status from the unlocked status by specifying the remote password. (Sets the device to the state where communication is not possible.)	—
Password Unlock	1630H	0000H	This command sets to the unlocked status from the locked status by specifying the remote password. (Sets the device to the state where communication is possible.)	—

Applicable devices

The following shows the available devices and device number ranges in commands used for the SLMP communication function.

3E frames

With 3E frames, specify the device to access with the "Device code" listed below.

Classification	Device	Type	Device code*1 (Device specification format: Long)		Device No.	Applicable FX5 CPU device*2		
			ASCII code	Binary code				
Internal user device	Input	Bit	X* (X***)	9CH (9C00H)	Specify in the range of device numbers of the module to access.	Octal	○	
	Output		Y* (Y***)	9DH (9D00H)		Octal	○	
	Internal relay		M* (M***)	90H (9000H)		Decimal	○	
	Latching relay		L* (L***)	92H (9200H)		Decimal	○	
	Annunciator		F* (F***)	93H (9300H)		Decimal	○	
	Edge relay		V* (V***)	94H (9400H)		Decimal	—	
	Link relay		B* (B***)	A0H (A000H)		Hexadecimal	○	
	Step relay		S* (S***)	98H (9800H)		—	Decimal	○
	Data register	Word	D* (D***)	A8H (A800H)	Specify in the range of device numbers of the module to access.	Decimal	○	
	Link register		W* (W***)	B4H (B400H)		Hexadecimal	○	
	Timer	Contact	Bit	TS (TS**)	C1H (C100H)	—	Decimal	○
		Coil	Bit	TC (TC**)	C0H (C000H)		○	
		Current value	Word	TN (TN**)	C2H (C200H)		○	
	Long timer	Contact	Bit	— (LTS*)	51H (5100H)	—	Decimal	—
Coil		Bit	— (LTC*)	50H (5000H)	—			
Current value		Double Word	— (LTN*)	52H (5200H)	—			
Retentive timer	Contact	Bit	SS (STS*)	C7H (C700H)	—	Decimal	○	
	Coil	Bit	SC (STC*)	C6H (C600H)		○		
	Current value	Word	SN (STN*)	C8H (C800H)		○		
Long retentive timer	Contact	Bit	— (LSTS)	59H (5900H)	—	Decimal	—	
	Coil	Bit	— (LSTC)	58H (5800H)		—		
	Current value	Double Word	— (LSTN)	5AH (5A00H)		—		
Counter	Contact	Bit	CS (CS**)	C4H (C400H)	—	Decimal	○	
	Coil	Bit	CC (CC**)	C3H (C300H)		○		

Classification	Device		Type	Device code ^{*1} (Device specification format: Long)		Device No.		Applicable FX5 CPU device ^{*2}
				ASCII code	Binary code			
Internal user device	Counter	Current value	Word	CN (CN**)	C5H (C500H)	Specify in the range of device numbers of the module to access.	Decimal	<input type="radio"/>
	Long counter	Contact	Bit	— (LCS*)	55H (5500H)			<input type="radio"/>
		Coil	Bit	— (LCC*)	54H (5400H)			<input type="radio"/>
		Current value	Double Word	— (LCN*)	56H (5600H)			<input type="radio"/>
	Link special relay		Bit	SB (SB**)	A1H (A100H)		Hexadecimal	<input type="radio"/>
	Link special register		Word	SW (SW**)	B5H (B500H)		Hexadecimal	<input type="radio"/>
System device	Special relay		Bit	SM (SM**)	91H (9100H)	—	Decimal	<input type="radio"/>
	Special register		Word	SD (SD**)	A9H (A900H)		Decimal	<input type="radio"/>
	Function input		Bit	—	—		Hexadecimal	—
	Function output			—	—		Hexadecimal	—
	Function register		Word	—	—		Decimal	—
Index register			16 bits	Z* (Z***)	CCH (CC00H)	Specify in the range of device numbers of the module to access.	Decimal	<input type="radio"/>
			32 bits	LZ (LZ***)	62H (6200H)		Decimal	<input type="radio"/>
File register			Word	R* (R***)	AFH (AF00H)	—	Decimal	<input type="radio"/>
				ZR (ZR**)	B0H (B000H)		Decimal	—
Link direct device ^{*3}	Link input		Bit	X* (X***)	9CH (9C00H)	—	Hexadecimal	—
	Link output			Y* (Y***)	9DH (9D00H)		Hexadecimal	—
	Link relay			B* (B***)	A0H (A000H)		Hexadecimal	—
	Link special relay			SB (SB**)	A1H (A100H)		Hexadecimal	—
	Link register		Word	W* (W***)	B4H (B400H)		Hexadecimal	—
	Link special register			SW (SW**)	B5H (B500H)		Hexadecimal	—
Module access device ^{*3}	Link register		Word	W* (W***)	B4H (B400H)	—	Hexadecimal	—
	Link special register			SW (SW**)	B5H (B500H)		Hexadecimal	—
	Module access device		G* (G***)	ABH (AB00H)	Decimal		<input type="radio"/>	

*1 [ASCII code]

If the device code is less than the specified character number, add "*" (ASCII code: 2AH) or a space (ASCII code: 20H) after the device code.

[Binary code]

When "Device code" is less than the size specified add "00H" to the end of the device code.

*2 : An FX5 CPU device exists

—: No FX5 CPU device

*3 "Device memory extension specification" for sub-commands must be turned ON (1).

5.4 Precautions

Checking communication status based on LED display

Check the status of the "SD/RD" LED display on the CPU module's built-in Ethernet port.

"SD/RD" LED indicator status	Operation status
Flashing	Data is being sent or received.
Off	Data is not being sent nor received.

The LED flashes brightly when performing SLMP (3E frame) communication normally.

If the LED is not flashing, check the wiring and the communication settings.

Checking communication status based on error code

For the error codes stored in the end code when there is an abnormal end of SLMP (3E frame) communication, refer to

☞ Page 112 SLMP function error code.

Number of connectable units

Up to 8 external devices can access one CPU module at the same time (including socket communication, MELSOFT connections, and SLMP).

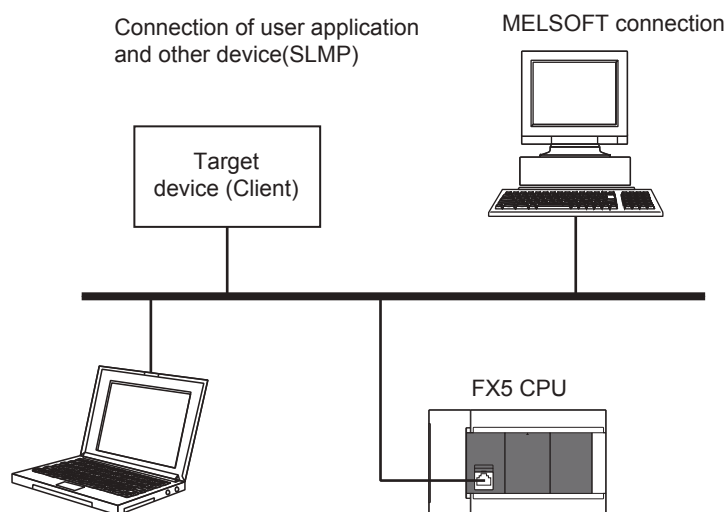

Maintenance

GX Works3, etc. (MELSOFT connection)

For connections with external devices by SLMP, the number of possible simultaneous connections is the number of devices configured in the Ethernet configuration settings only.

Data communication frames

The frames that can be used on the CPU module are the same as MC protocol QnA-compatible 3E frames.

Access range

- Only the connected CPU module can be accessed. Transmissions to other modules will result in an error.
- Communication with other stations such as CC-Link via the connected CPU module cannot be done.

For details of the access range, refer to the MELSEC iQ-F FX5 User's Manual(SLMP).

Precautions when the protocol is set to UDP

- For a single UDP port, if a new request message is sent while waiting for the response message after sending the first request message, the new request message will be discarded.
- When the same local port number has been set multiple times in UDP, the result is the same as if only one has been set. If you want to communicate with multiple external devices using the same local port number, use TCP.

Data reception processing for response messages

The following shows an example of the data reception processing of an external device.

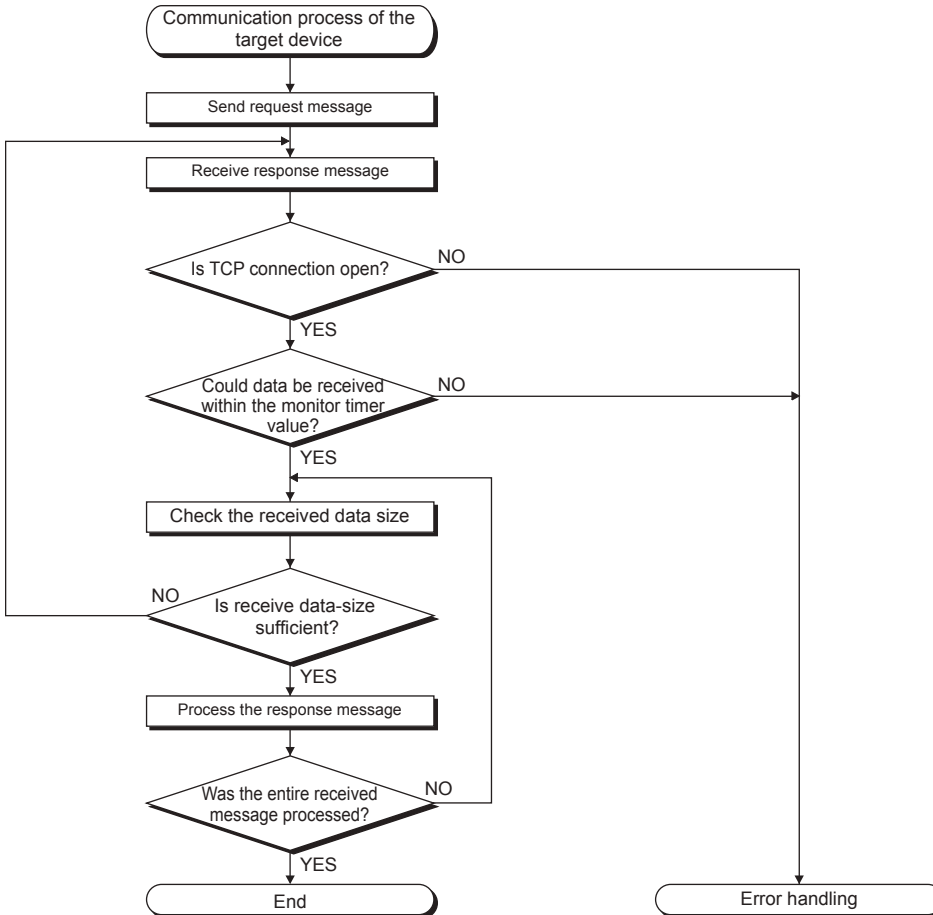

Point

For Ethernet communication, TCP socket functions are used inside personal computers.

These functions have no concept of boundaries. When the sender sends data by calling the send function once, the receiver will call the recv function once or more to read that data. (Send and recv do not have a one-to-one correspondence.)

Therefore, the processing shown above is always required in the program of the receiving device.

When the recv function is used with the blocking mode, data may be read by calling the function once.

6 PREDEFINED PROTOCOL SUPPORT FUNCTION

This chapter describes predefined protocol support function (built-in Ethernet).

For details on the predefined protocol support function (serial communication), refer to  MELSEC iQ-F FX5 User's Manual(Serial Communication).

Outline

Data can be exchanged between the external device (such as measuring instrument and bar code reader) and the CPU module following the protocol of the device.

Data that varies according to communication session can be handled by incorporating a device or buffer memory into the communication packet.

Sets the protocol required for communication with the external device using the engineering tool.

The protocol can be set by selecting from the predefined protocol library (SLMP, MODBUS/TCP*¹, etc.), or it can be created and edited.

*1 The SLMP and MODBUS/TCP are available only in the client.

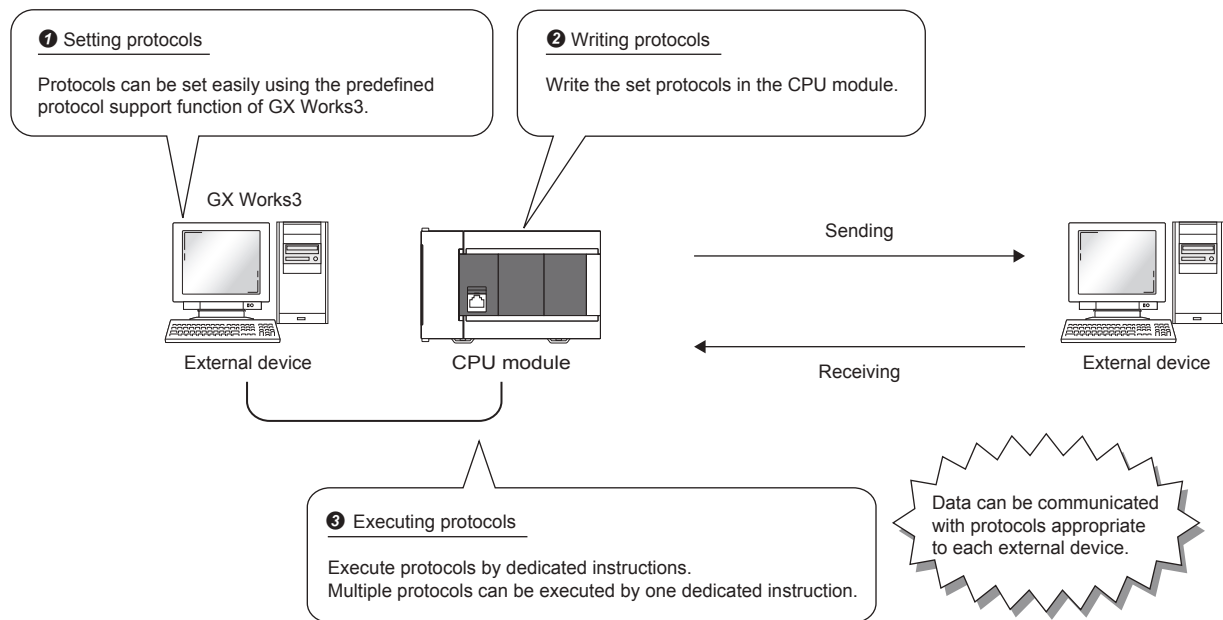

Point

The number of protocols and packets that can be registered is as follow.

- Protocols: 64 maximum
- Packets: 128 maximum
- Packet data area size: 6144 bytes maximum

When the number of packets reaches the upper limit, protocols cannot be added even if the number of protocols has not reached the upper limit.

If the packet data area size reaches the upper limit, protocols and packets cannot be added even if the number of protocols and packets has not reached the upper limit.

Applicable connections

The connections Nos. 1 to 8 can be used for communications using the communication protocol support function.

6.1 Data Communication

When the predefined protocol support function is used, data can be exchanged with the external device using the following procedure.

1. Select, create or edit the protocol with the predefined protocol support function, and write the protocol setting data. (☞ Page 40 Creating the protocol setting data)
2. Set the module parameter. (☞ Page 45 Module parameter setting procedure)
3. Write the parameters to the CPU module.
4. Perform the open processing to establish a connection between the CPU module and external device.
5. Execute the protocol with the dedicated instruction (SP.ECPRTCL instruction).
6. Close the connection when communication is finished.

Point

The communication data code is binary code communication regardless of the selected settings.

Creating the protocol setting data

Use the predefined protocol support function to create the protocol setting data.

[Tool] ⇒ [Predefined Protocol Support Function]

Select the module for which to create the protocol setting data.

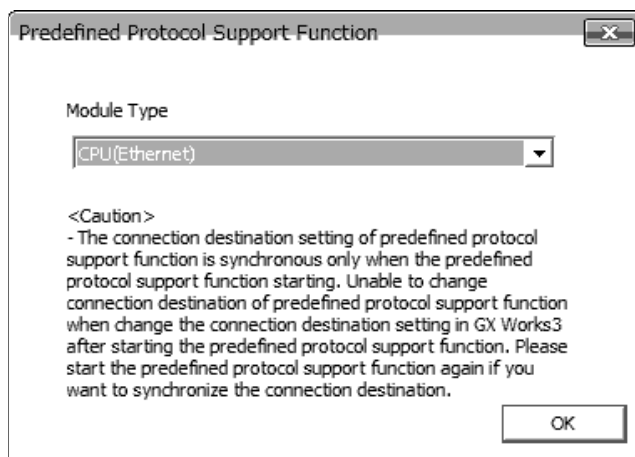

■ Newly creating the protocol setting data

Newly create the protocol setting data.

[File] ⇒ [New] ⇒ "Protocol Setting" screen

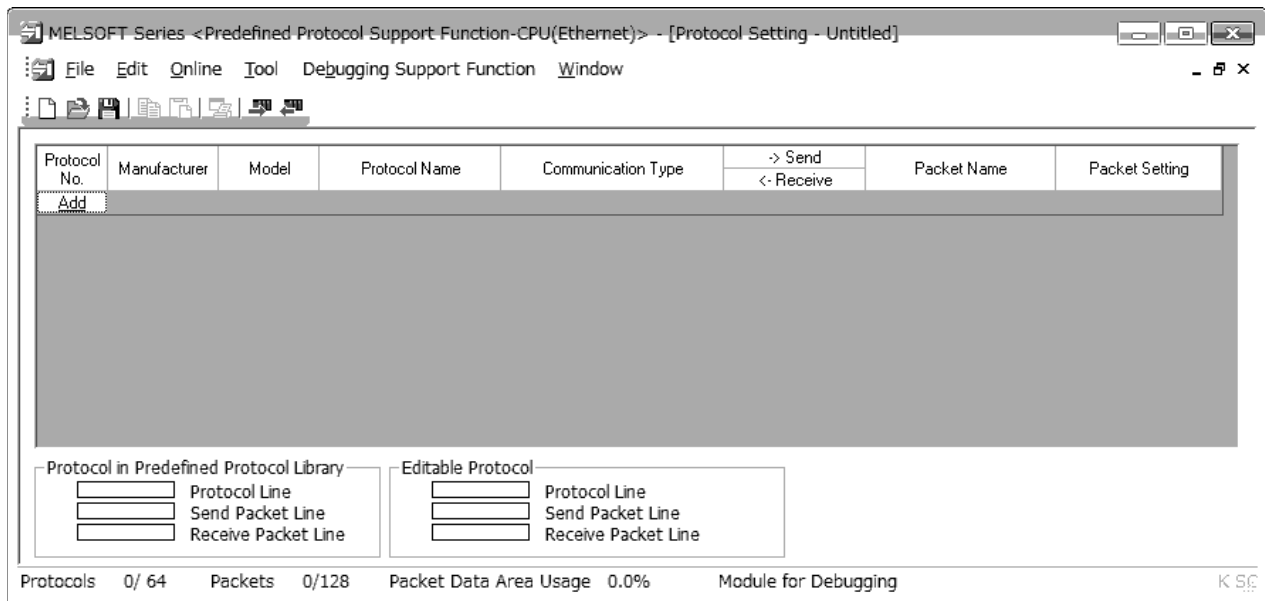

Item	Description
Protocol No.	Displays the protocol number used with the dedicated instruction.
Manufacturer	Displays the name of the manufacturer of the device for which the protocol is being set.
Model	Displays the model of the protocol to be set.
Protocol Name	Displays the name of the protocol to be set.
Communication Type	Displays the communication type of the protocol to be set. Send only: Sends one send packet once. Receive only: If there is a matching packet within up to 16 registered and received packets, it is received. Send & receive: After sending one send packet, if there is a matching packet within up to 16 registered and received packets, it is received.
->Send/<-Receive	Displays the packet send direction. ->: For send <-(1) to (16): For receive, the received packet number is displayed in parentheses.
Packet Name	Displays the packet name.
Packet Setting	Displays the validity of variables in the packet elements and the variable setting state. If Variable Unset, Elements Unset, or Element Error, the protocol is not written to the CPU module. No Variable: When there is no variable in the elements Variable Set: Only when all variables have been set Variable Unset: When there is an unset variable Elements Unset: When there are no elements in an editable protocol Element Error: When elements do not satisfy requirements

■ Adding protocol

Add protocol.

 [Edit] ⇄ [Add Protocol]

Add Protocol ✕

Adds new protocol.

Selection of Protocol Type to Add _____

Type : Predefined Protocol Library ▾ Reference

* Select from Predefined Protocol Library.
Please select manufacturer, model and protocol name from Protocol to Add.

Protocol to Add _____

Protocol No.	Manufacturer	Model	Protocol Name
1	General-purpose protocol	SLMP(Device Read)	▾

OK
Cancel

Item	Description	Setting range
Type	Select the type of protocol to be added.	<ul style="list-style-type: none"> • Predefined Protocol Library • User Protocol Library • Add New
Protocol No.	Select the protocol number to be added.	1 to 64
Manufacturer ^{*1}	Set the maker of the protocol to be added.	—
Model ^{*1}	Set the type of protocol to be added.	—
Protocol Name ^{*1}	Set the name of the protocol to be added.	—

*1 The name can be set only when "Predefined Protocol Library" is selected for "Type"

■ Protocol Detailed Setting

Set the protocol send/receive parameters.

 "Protocol Setting" window ⇒ Select a protocol ⇒ [Edit] ⇒ [Protocol Detailed Setting]

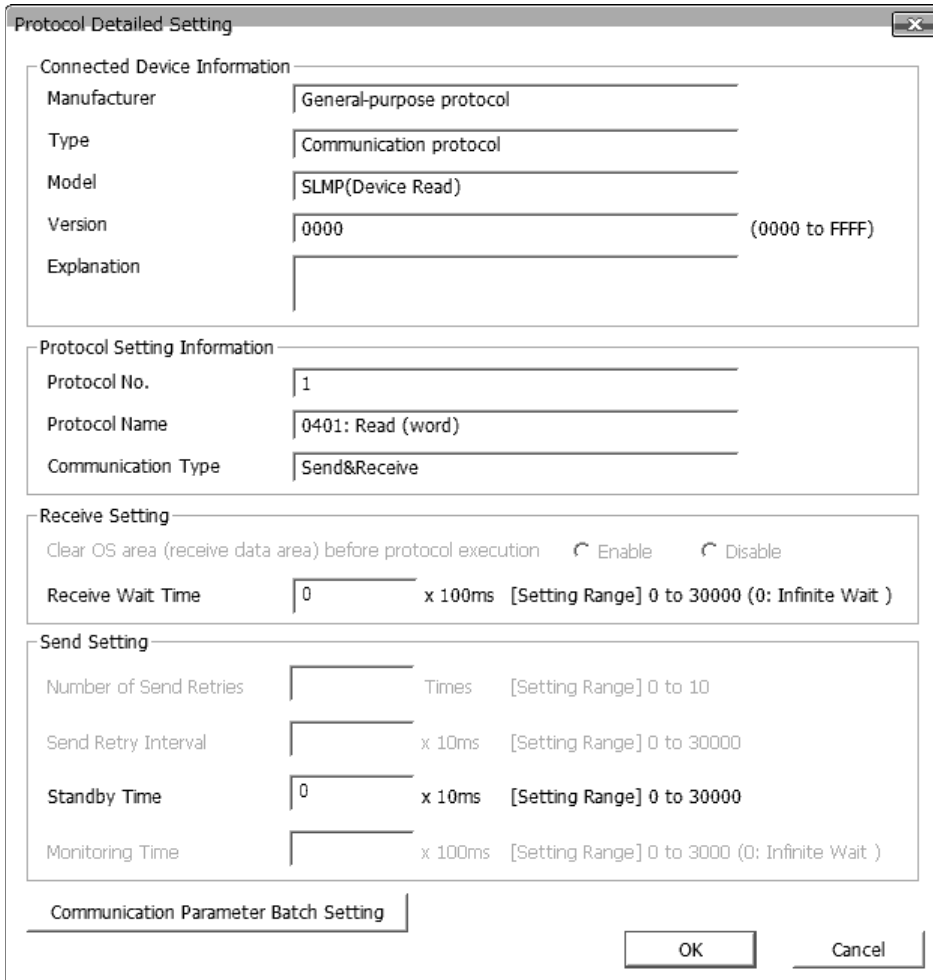

Item	Description	
Connected Device Information ^{*1}	Manufacturer	Set the protocol maker name.
	Type	Set the protocol device type.
	Model	Set the protocol model.
	Version	Set the protocol device version.
	Explanation	Set a description of the protocol device.
Protocol Setting Information ^{*1}	Protocol No.	The protocol number for the selected protocol is displayed.
	Protocol Name	Set the protocol name.
	Communication Type	Type Set the protocol communication type.
Receive Setting	Receive Wait Time	Set the time for wait after the module enters the receive data wait state. If communication with the external device is disabled because of a disconnection and matching packet data is not received within the specified time, the module judges that an error has occurred and cancels the receive data wait state.
Send Setting	Standby Time	Set the time to wait from when the protocol set for the module enters the execution state to when the data is actually sent. The time for the external device to enter the receive enable state can be adjusted with this in respect to the module's send timing.

*1 The setting cannot be changed if the protocol was selected from the predefined protocol library.

Point

Send/receive parameters can be set for multiple protocols by clicking the [Communication Parameter Batch Setting] button and setting the range of the set protocol numbers, receive settings, and send settings.

■Packet setting

Set the configuration of the send/receive packets on the "Packet Setting" window.

 "Protocol Setting" window ⇒ Packet to be set

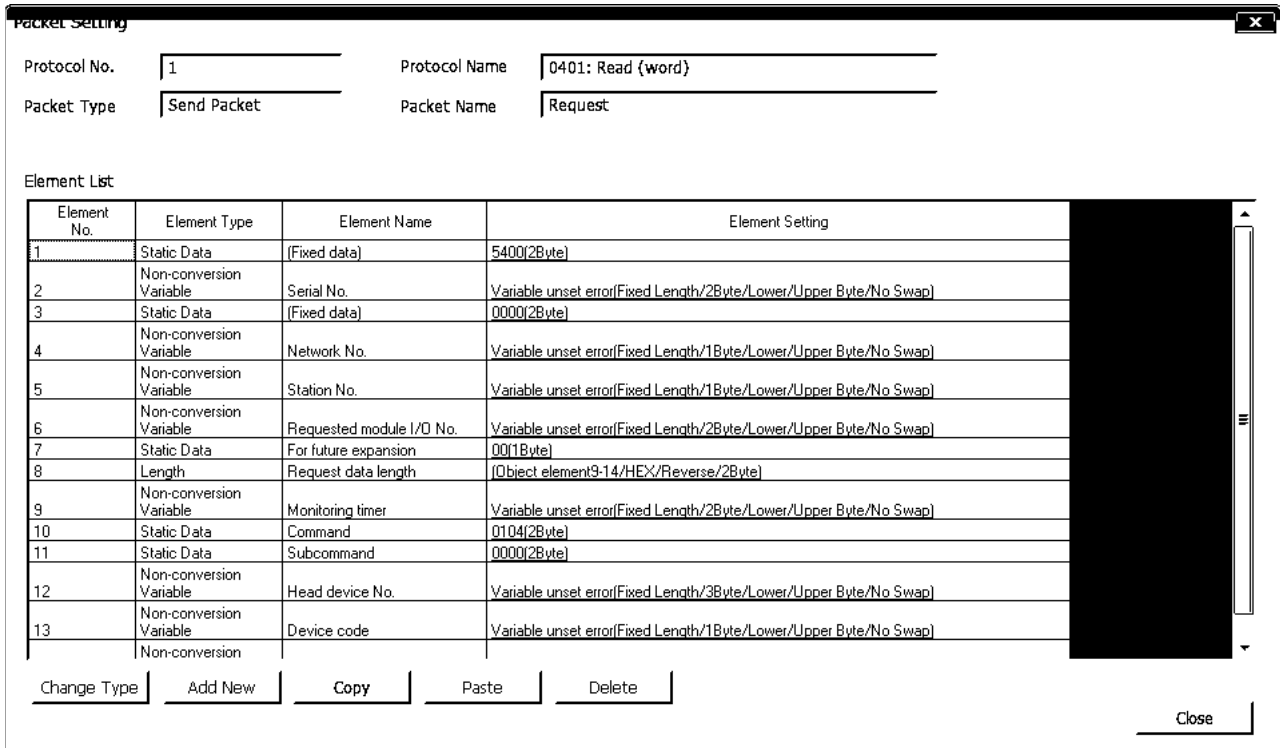

Packet Setting

Protocol No. Protocol Name

Packet Type Packet Name

Element List

Element No.	Element Type	Element Name	Element Setting
1	Static Data	(Fixed data)	5400(2Byte)
2	Non-conversion Variable	Serial No.	Variable unset error(Fixed Length/2Byte/Lower/Upper Byte/No Swap)
3	Static Data	(Fixed data)	0000(2Byte)
4	Non-conversion Variable	Network No.	Variable unset error(Fixed Length/1Byte/Lower/Upper Byte/No Swap)
5	Non-conversion Variable	Station No.	Variable unset error(Fixed Length/1Byte/Lower/Upper Byte/No Swap)
6	Non-conversion Variable	Requested module I/O No.	Variable unset error(Fixed Length/2Byte/Lower/Upper Byte/No Swap)
7	Static Data	For future expansion	00(1Byte)
8	Length	Request data length	(Object element9-14/HEX/Reverse/2Byte)
9	Non-conversion Variable	Monitoring timer	Variable unset error(Fixed Length/2Byte/Lower/Upper Byte/No Swap)
10	Static Data	Command	0104(2Byte)
11	Static Data	Subcommand	0000(2Byte)
12	Non-conversion Variable	Head device No.	Variable unset error(Fixed Length/3Byte/Lower/Upper Byte/No Swap)
13	Non-conversion Variable	Device code	Variable unset error(Fixed Length/1Byte/Lower/Upper Byte/No Swap)

Change Type Add New Copy Paste Delete

Close

The above window opens when "Predefined Protocol Library" is selected on the "Add Protocol" window.

When "Add New" or "User Protocol Library" has been selected, configure the packets with the [Change Type] button and [Add New] button.

For details on the packet elements, refer to the following.

 Page 46 Packet Elements

■Writing the protocol setting data

Write the protocol setting data to the CPU module.

 [Online] ⇒ [Write to Module]

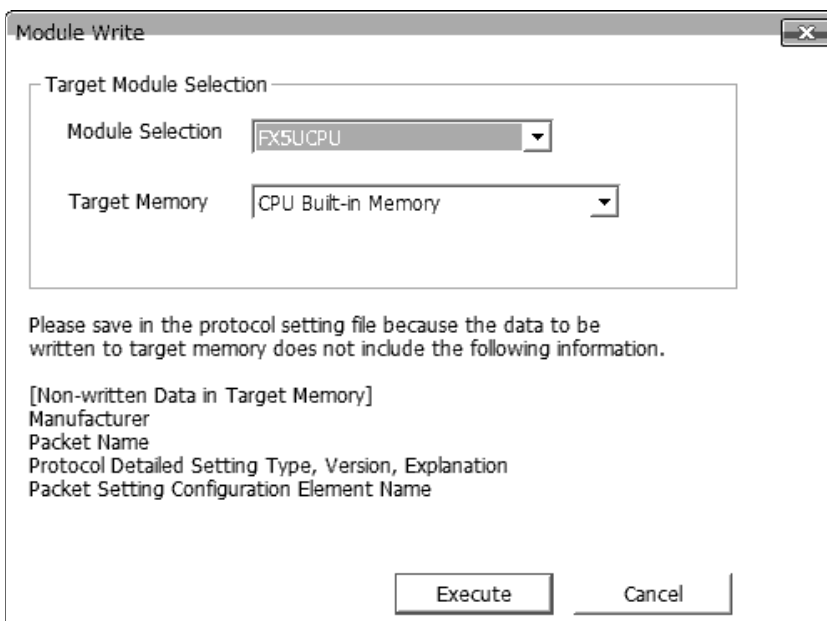

Module Write

Target Module Selection

Module Selection

Target Memory

Please save in the protocol setting file because the data to be written to target memory does not include the following information.

[Non-written Data in Target Memory]
 Manufacturer
 Packet Name
 Protocol Detailed Setting Type, Version, Explanation
 Packet Setting Configuration Element Name

Execute Cancel

Select the module and memory into which the protocol data is to be written, and execute write.

The protocol setting data is written into the module extension parameters.

The following data is not written as the protocol setting data so it will not be displayed even when read. However, when the protocol is selected from the predefined protocol library, the following can be displayed.

- Manufacturer
- Packet name
- Type, version, and explanation in the protocol detailed setting
- Element name in packet settings

When the predefined protocol settings are written into multiple target memories, the following operation will take place.

When written into both the CPU built-in memory and SD memory card:

Operation follows settings in "Memory Card Parameter".

The predefined protocol settings written in the SD memory card can be transferred to the CPU built-in memory by using boot operation.

For details on boot operation, refer to the following.

 MELSEC iQ-F FX5 User's Manual(Application)

Module parameter setting procedure

Set "External Device Configuration" under "Basic Settings".

 Page 52 Parameter settings

1. Select the external device to be connected in "Module List" and drag it to "List of devices" or "Device map area".

External device name	Description
UDP Connection Module	Select to communicate with the external device using UDP/IP
Active Connection Module	Select to perform the open processing to the external device from the CPU module (Active open) and communicate using TCP/IP.
Unpassive Connection Module	Select to receive the open processing from a unspecified external device (Unpassive open) and communicate using TCP/IP.
Fullpassive Connection Module	Select to receive the open processing from the specified external device (Fullpassive open) and communicate using TCP/IP.

2. Set "Communication Procedure" for the external device to "Predefined Protocol".
3. Set the other parameters required for communication in the connection.

Applicable dedicated instructions

The dedicated instruction "SP.ECPRTCL" is used in the communication protocol support function (built-in Ethernet).

6.2 Protocol Communication Type

The packets sent to the external device when a processing is executed and the external device's receive packets are registered in the protocol.

The packet elements set with the predefined protocol support function are the data section of the packets that are actually sent and received.

This section describes an example of the packet configuration.

For TCP/IP

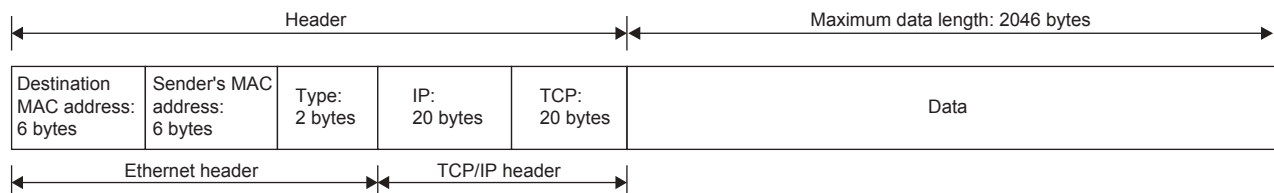

For UDP/IP

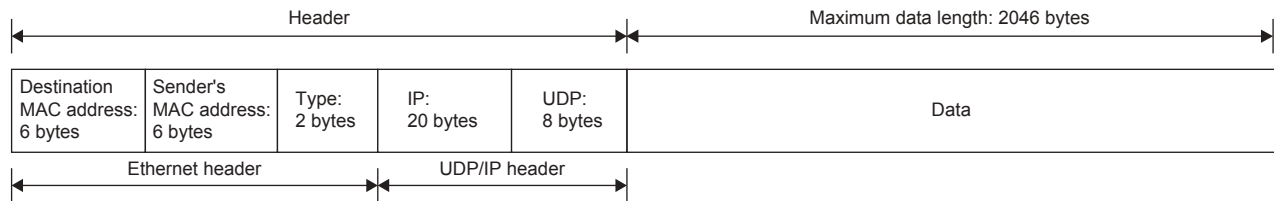

With the predefined protocol support function, data is exchanged with the external device with the procedures (communication type) shown below.

Communication type	Description
Send Only	The send packet is sent once.
Receive Only	If there is a packet that matches within the maximum of 16 registered receive packets, the packet is received.
Send & Receive	After sending the send packets, if there are packets that match the up to 16 registered receive packets, the packets are received.

6.3 Packet Elements

The packet is created with a combination of packet elements.

Up to 32 elements can be set in one packet. One packet can have a maximum data length of 2046 bytes.

This section describes the details of the packet elements.

Static data

The screenshot shows the 'Element Setting - Static Data(Send)' dialog box. It has three main input areas: 'Element Name' (a text field), 'Code Type' (a dropdown menu currently showing 'ASCII String'), and 'Setting Value' (a large text area showing '(0 byte)'). Below the text area, it says '[Setting Range] 1 to 50'. At the bottom, there are 'OK' and 'Cancel' buttons.

Use when there are specific codes and character strings, such as commands, in the packet.

- When sending: The specified code and character string are sent.
- When receiving: The received data is verified.

Multiple static data elements can be placed anywhere in the data part.

The following table lists the items.

Item	Description	Remarks
Element Name	Set the element name.	—
Code Type	Select a data type of the setting value. ASCII String/ASCII Control Code/HEX	—
Setting Value	Set data within 1 to 50 bytes. Code type and setting range are as follows: <ul style="list-style-type: none"> • ASCII String: 20H to 7EH • ASCII Control Code: Control code of 00H to 1FH and 7FH • HEX: Hexadecimal data of 00H to FFH 	Setting example ASCII String: "ABC" ASCII Control Code: STX HEX: FFFF

Length

The length code is used when there is an element that indicates the data length in the packet.

- When sending: Automatically calculates the data length in the specified range, and adds it to the packet.
- When receiving: From the received data, the data (value) corresponding to the length is verified as the specified range's data length.

Length elements can be placed anywhere in the data part.

Multiple length elements can be set placed in one packet.

The following table lists the items.

Item	Description	Remarks	
Element Name	Set the element name.	—	
Code Type	Select the data length type. ASCII hexadecimal/HEX	—	
Data Length	Select the data length on the line. The range is 1 to 4 bytes.	—	
Data Flow	Forward Direction (Upper byte → Lower byte)	When sending: Sends the calculated length in order from the upper byte. When receiving: Receives the data in order from the upper byte.	This cannot be set if the data length is 1 byte.
	Reverse Direction (Lower byte → Upper byte)	When sending: Sends the calculated length in order from the low-order byte. When receiving: Receives the data in order from the low-order byte.	
	Byte Swap (by Word) ^{*1}	When sending: Interchanges the bytes in word units and sends the calculated length. When receiving: Interchanges the bytes in word units and receives the data.	
Calculating Range	Start	Select the start packet element number for the range to be calculated. The range is 1 to 32.	—
	End	Select the end packet element number for the range to be calculated. The range is 1 to 32.	

*1 This can be selected only when the data length is set to 4 bytes.

Point

- If there are no elements other than length, an element error occurs. (When using length, one or more elements other than length are required.)
- If the calculation result exceeds the number of digits set with "Data Length", the excessive digit value is discarded (invalidated). For example, if Data Length is 2 bytes and the data size calculation results are "123" bytes, the data length will be "23".
- If there is a non-conversion variable (variable length)/non-verified reception (character length variable) after the length, and that section is not included in the length calculating range, arrange the static data immediately after the non-conversion variable/non-verified reception.
- When the code type setting is "ASCII Hexadecimal", a mismatch will occur if a character string other than "0" to "9", "A" to "F", and "a" to "f" is received.
- Use "0" to "9" or "A" to "F" when converting to ASCII characters during send.
- When arranging multiple length elements, none of the length calculating range may overlap.
- When arranging multiple length elements, the previous length calculating range may not exceed the arranged length.
- A length element cannot be arranged at the final position of the packet elements.

Non-conversion variable

Use this to send the CPU module device data as part of the send packet, or to store part of the received packet in the CPU module device.

Multiple non-conversion variable can be arranged in one packet.

The following table lists the items.

Item	Description	
Element Name	Set the element name.	
Fixed Length/ Variable Length	Fixed Length	The data whose length is fixed is sent and received.
	Variable Length	When sending: The data length is specified at the time of the protocol execution and the data is sent. When receiving: The data whose length is variable is received.
Data Length/ Maximum Data Length	Set the data length of the send/receive data. (For a variable length, set the maximum data length that can be specified for the data length storage area.) The range is 1 to 2046.	
Unit of Stored Data	Lower byte + Upper byte	When sending: Each one word (2 bytes) data in the data storage area is sent in the order of the lower byte to the upper byte. When receiving: The receive data is stored to the data storage area in the order of the lower byte to the upper byte.
	Lower Bytes Only	When sending: Each lower byte data in the data storage area is sent. The CPU module ignores the upper byte data. When receiving: The receive data is stored to each lower byte in the data storage area. The CPU module stores 00H in the upper byte.
Byte Swap	Disable (Lower -> Upper)/ Enable (Upper -> Lower)	When sending: When "Enable (Upper -> Lower)" is selected, data in the upper byte and lower byte are swapped by one word (2 bytes) and sent. When "Unit of Stored Data" is "Lower Byte + Upper Byte" and "Data Length" is an odd number of bytes, the upper byte is sent at transmission of the last byte. When "Unit of Stored Data" is "Lower Bytes Only" and "Data Length" is an odd number of bytes, data without any byte swap is sent at transmission of the last byte. When receiving: When "Enable (Upper -> Lower)" is selected, data in the upper byte and lower byte are swapped by word and sent. When "Unit of Stored Data" is "Lower Byte + Upper Byte" and "Data Length" is an odd number of bytes, the last byte is stored to the upper byte. When "Unit of Stored Data" is "Lower Bytes Only" and "Data Length" is an odd number of bytes, the last byte is stored without any byte swap.
Data Storage Area Specification	Specify the start device for storing the variable value. The settable devices are listed below. User device ^{*1,2} <ul style="list-style-type: none"> • Input (X) • Output (Y) • Internal relay (M) • Latch relay (L) • Link relay (B) • Data register (D) • Link register (W) File register ^{*2} <ul style="list-style-type: none"> • File register (R) 	

*1 Do not set local devices.

*2 Set within the device range specified with "Device/Label Memory Area Setting" in "Memory/Device Setting" under "CPU Parameters".

The following figures show the configuration of the data storage area.

■When "Fixed Length/Variable Length" is "Fixed Length"

The area after the device number specified on the "Element Setting" window becomes the data storage area.

The occupied data storage area differs according to the "Unit of Stored Data".

- When "Lower Byte + Upper Byte" is selected, the same size as the data length is occupied. (However, when the data length of a send packet is an odd number, the upper byte (lower byte for "Byte Swap") of the end device is not sent. When the data length of a receive packet is an odd number, the last data is stored with one byte of 00H.)
- When "Lower Bytes Only" is selected, a size double the data length is occupied.

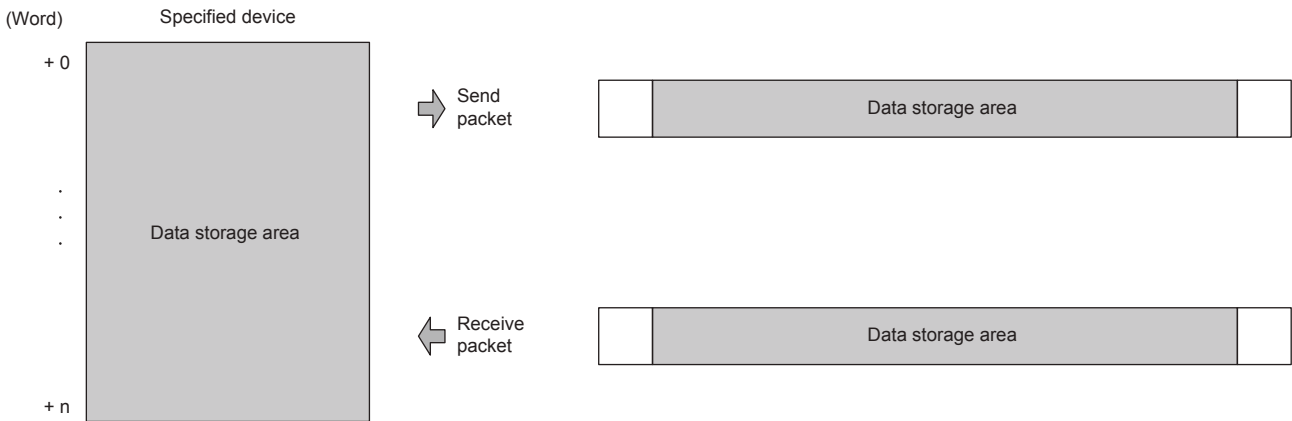

For send packet: Send data is stored by the program

For receive packet: Receive data is stored by the CPU module

■When "Fixed Length/Variable Length" is "Variable Length"

The area after the device number specified on the "Element Setting" window + 1 becomes the data storage area.

The occupied data storage area differs according to the "Unit of Stored Data".

- When "Lower Byte + Upper Byte" is selected, the same size as the data length + one word (length for the data length storage area) are occupied. (However, when the data length of a send packet is an odd number, the upper byte (lower byte for "Byte Swap") of the end device is not sent. When the data length of a receive packet is an odd number, the last data is stored with one byte of 00H.)
- When "Lower Bytes Only" is selected, a size double the data length + one word (for data length storage area) is occupied.

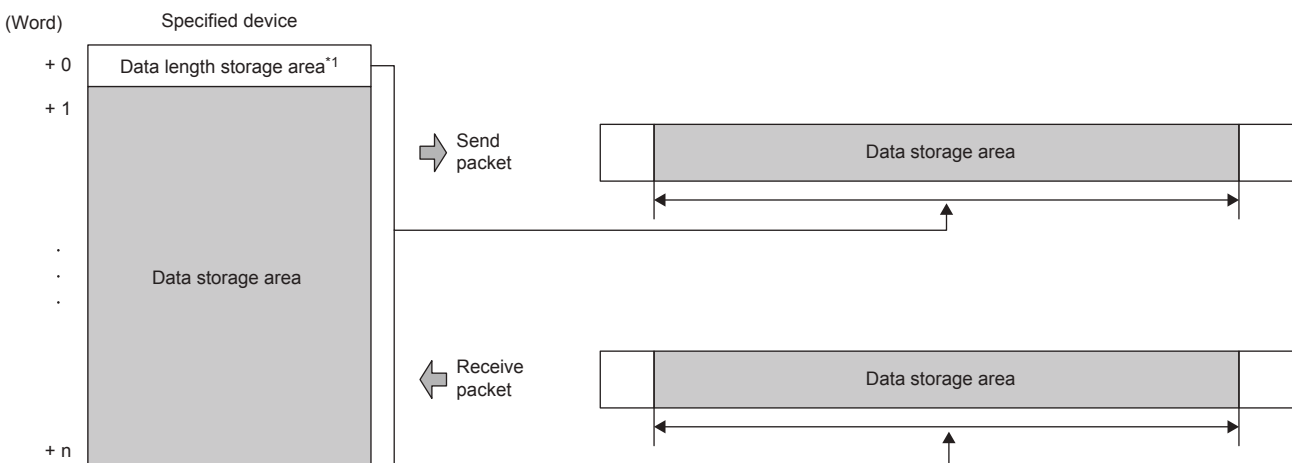

For send packet: Send data is stored by the program

For receive packet: Receive data is stored by the CPU module

*1 The data length unit is byte fixed

When "Fixed Length/Variable Length" is "Variable Length" and the configuration is set as follows, an error occurs:

- An element other than static data is placed behind a non-conversion variable element when non-conversion variable is out of the length calculating range or when there is no length element (except for when nonconversion variable is placed at the end of the packet elements).
- Multiple non-conversion variable elements are placed in the length calculating range, while a length element is not placed.
- A non-conversion variable element is placed before a length element in the length calculating range.

Non-verified reception

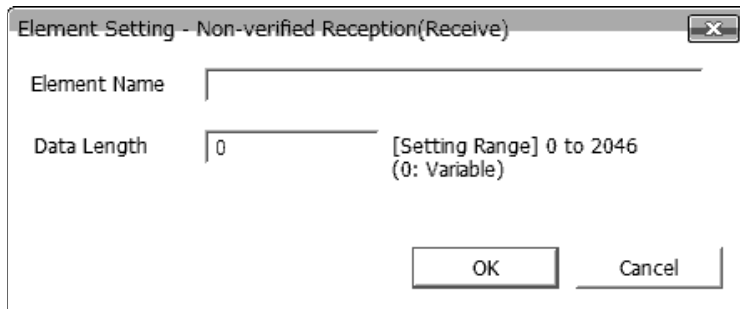

Use this when receive data include unnecessary data.

If the receive packet contains non-verified reception, CPU module skims over the specified number of characters.

Multiple non-verified reception elements can be set in one packet.

The following table lists the items.

Item	Description	
Element Name	Set the element name.	
Data Length	0 (Number of characters variable)	Set when the number of characters that are not verified differs between each communication session.
	1 to 2046 (number of character specification)	Set the number of characters that are not verified.

When "Data Length" is set to 0, an error will occur if the following layout is used.

- An element other than static data is placed behind a non-verified reception element when non-verified reception is out of the length calculating range or when there is no length element (except for when non-verified reception is placed at the end of the packet elements).
- Multiple non-verified reception elements are placed in the length calculating range, while a length element is not placed.
- A non-verified reception element is placed before a length element in the length calculating range.

6.4 Execution Conditions of Predefined Protocol Communications

The predefined protocol communications can be executed when "Predefined protocol ready (SD10692)" is "1". This section describes the operation of 'Predefined protocol ready' (SD10692).

When the system is powered on or reset

If protocol setting data is written, the CPU module checks the protocol setting data when the system is powered on or reset. If the protocol setting data is normal, the CPU module sets "Predefined protocol ready (SD10692)" to "1" and enables execution of the protocol.

'Predefined protocol ready' (SD10692) is used as the interlock signal for executing the protocol.

If the protocol setting data is abnormal, "Predefined protocol ready (SD10692)" remains "0", and the details of the error are stored in SD10710 to SD10713 in the "Predefined protocol setting data check area".

If protocol setting data is not written, the protocol setting data is not checked, and "Predefined protocol ready (SD10692)" remains "0".

Whether the protocol setting data is registered or not can be checked with 'Number of registered predefined protocols' (SD10714) and 'Predefined protocol registration' (SD10722 to SD10725).

When protocol setting data is normal

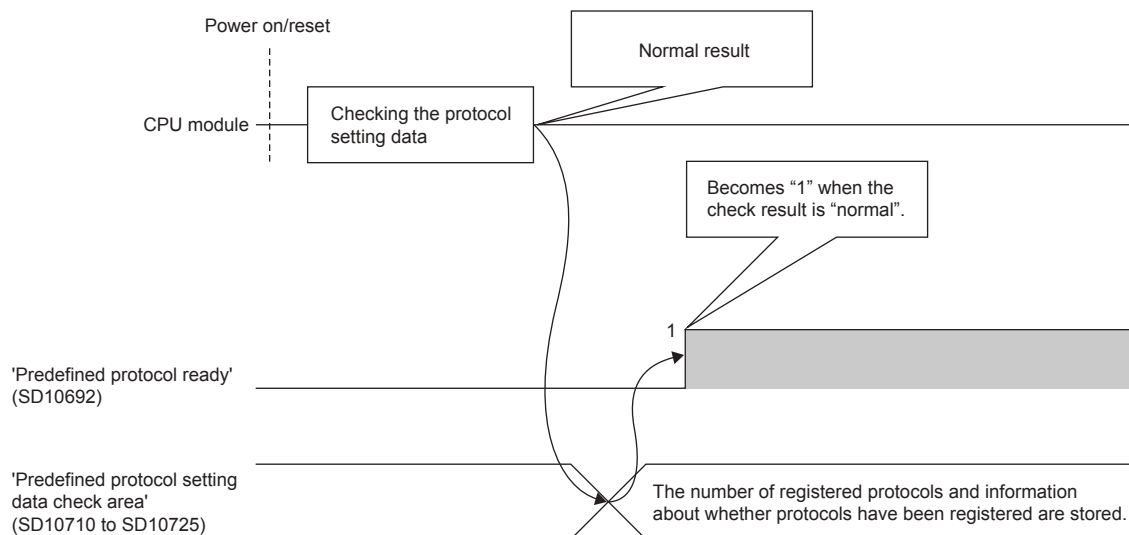

When protocol setting data is abnormal

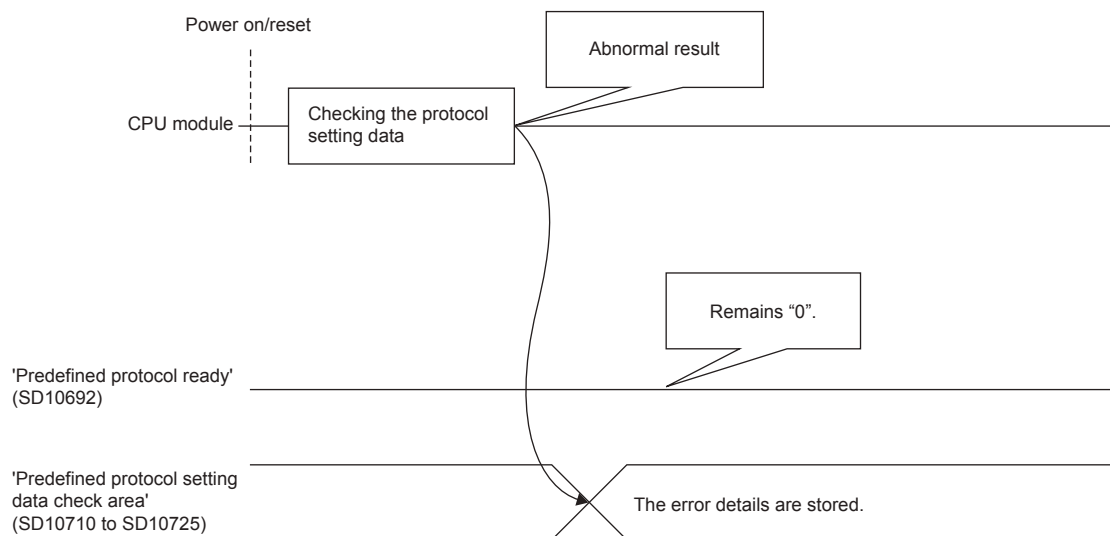

6.5 Example of Predefined Protocol Communications

This section describes an example of predefined protocol communications using UDP/IP.

System configuration

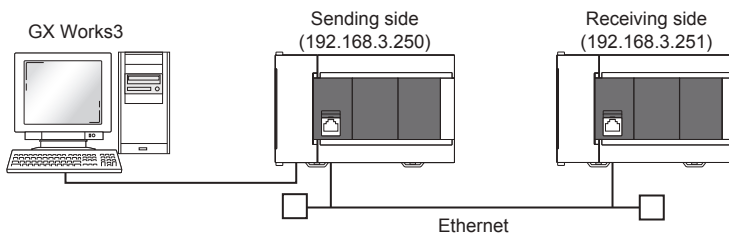

Parameter settings

Connect GX Works3 to the CPU module and set the parameters.

■ Sending side

1. Set the CPU module in the following.

[Project] ⇒ [New]

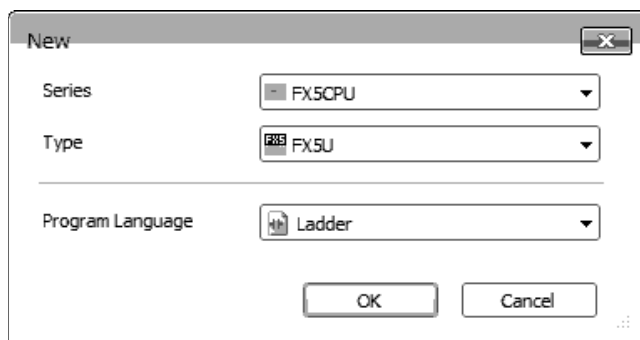

2. Click the [Yes] button to add the module labels of the CPU module.

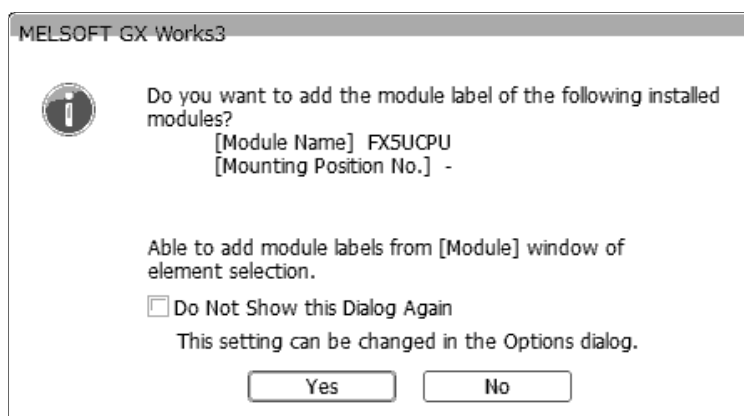

3. Set the "Basic Settings" in the following.

Navigation window ⇒ [Parameter] ⇒ [FX5UCPU] ⇒ [Module Parameter] ⇒ [Ethernet Port] ⇒ [Basic Settings]

Setting Item List

- Basic Settings
- Own Node Settings
- External Device Configuration
- Application Settings

Setting Item

Item	Setting
Own Node Settings	
IP Address	192.168.3.250
Subnet Mask	
Default Gateway	
Communication Data Code	Binary
External Device Configuration	
External Device Configuration	<Detailed Setting>

Explanation

Set the IP address of the own node.
 Ensure that the own node and the external device to be communicated with have the same class and subnet address. IP address has been set in the range of class A/B/C.
 If IP address is not set, the module operates with following IP address.
 192.168.3.250
 [Setting range]
 - Empty (no setting)
 - 0.0.0.1 to 223.255.255.254 (in decimal)

Buttons: Check, Restore the Default Settings, Apply

4. Set the external device configuration in the following.

Navigation window ⇒ [Parameter] ⇒ [FX5UCPU] ⇒ [Module Parameter] ⇒ [Ethernet Port] ⇒ [Basic Settings] ⇒ [External Device Configuration]

Ethernet Configuration (Built-in Ethernet Port)

Ethernet Configuration Edit View Close with Discarding the Setting Close with Reflecting the Setting

No.	Model Name	Communication Method	Protocol	Fixed Buffer Send/Receive Setting	PLC		Sensor/Device				Existence Confirmation	
					IP Address	Port No.	MAC Address	Host Name	IP Address	Port No.		Subnet Mask
1	UDP Connection Module	Socket Communication	UDP		192.168.3.250	8192			192.168.3.251	4096		Do not confirm existence

Module List

- Ethernet Selection Find Module M 4
- Ethernet Device (General)
 - MELSOFT Connection Module
 - SLMP Connection Module
 - UDP Connection Module
 - Active Connection Module
 - Unpassive Connection Module
 - Fullpassive Connection Module
- Ethernet Device (COGNEX)
 - COGNEX Vision System
- Ethernet Device (Panasonic Industrial)
 - Laser Displacement Sensor

[Outline]
 UDP Connection Module
[Specification]
 Use when specify open method by UDP

Output

5. Start the predefined protocol support function.

[Tool] ⇒ [Predefined Protocol Support Function]

6. Select "CPU(Ethernet)" for "Module Type" and click the [OK] button.

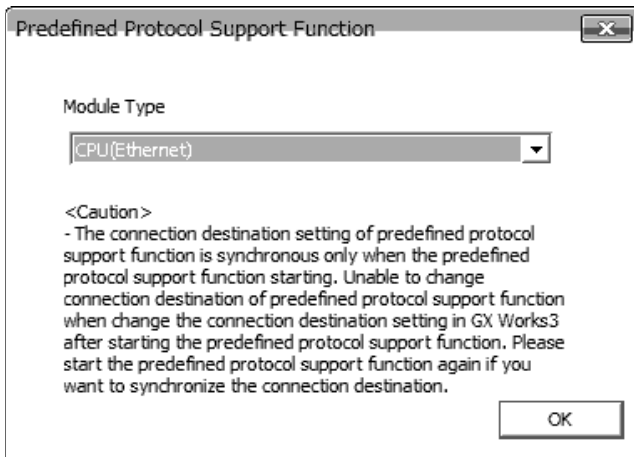

7. Newly create the protocol setting.

[File] ⇨ [New]

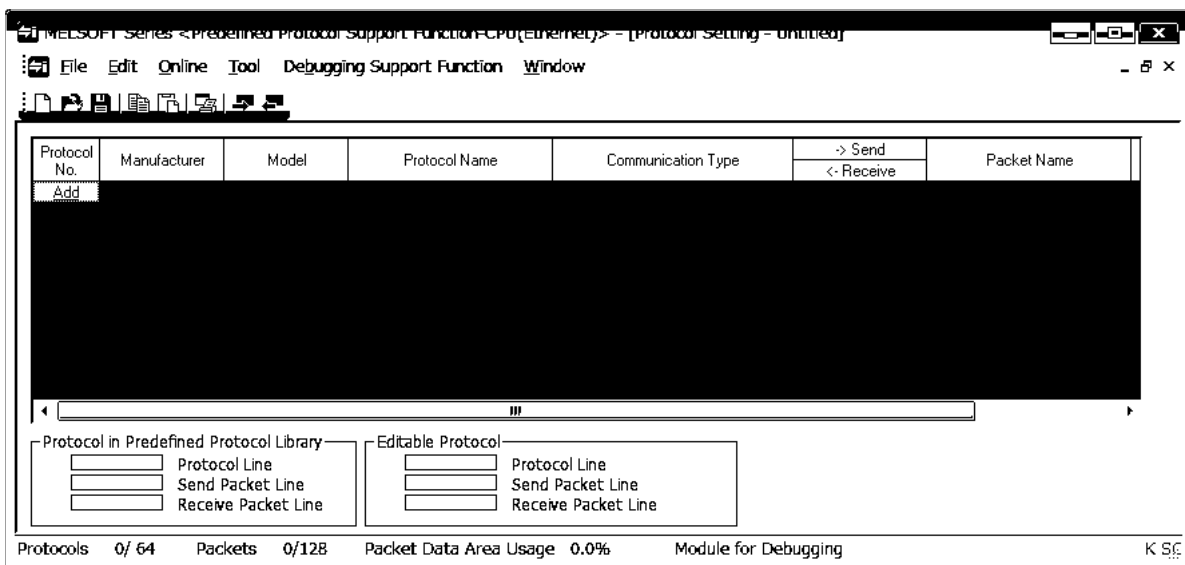

8. Set a protocol in the following.

[Edit] ⇨ [Add Protocol]

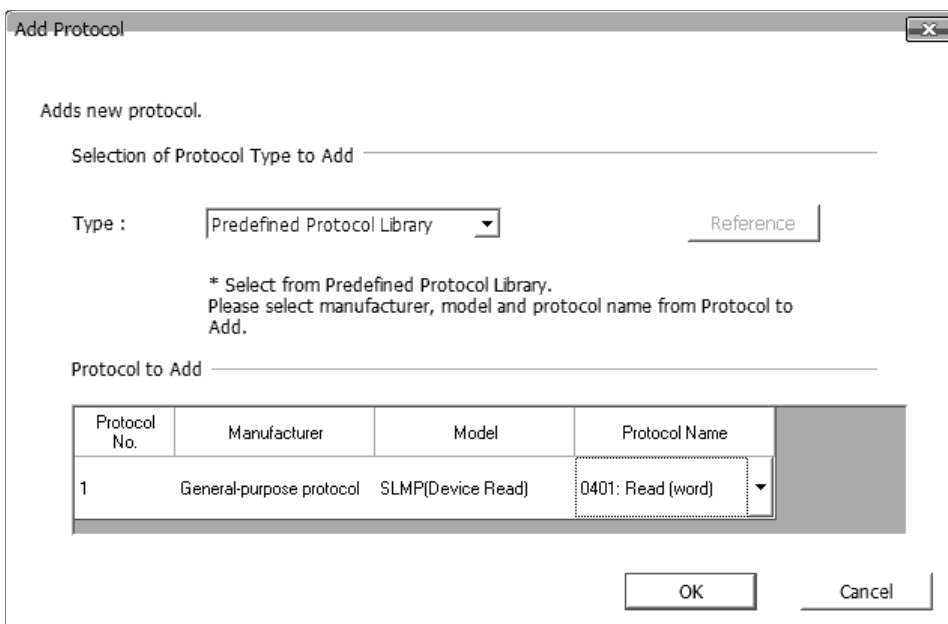

9. Set each packet in the following.

"Protocol Setting" window ⇒ Packet to be set

- Request

Packet Setting

Protocol No. Protocol Name

Packet Type Packet Name

Element List

Element No.	Element Type	Element Name	Element Setting
1	Static Data	(Fixed data)	5400(2Byte)
2	Non-conversion Variable	Serial No.	[D0-D0](Fixed Length/2Byte/Lower/Upper Byte/No Swap)
3	Static Data	(Fixed data)	0000(2Byte)
4	Non-conversion Variable	Network No.	[D1-D1](Fixed Length/1Byte/Lower/Upper Byte/No Swap)
5	Non-conversion Variable	Station No.	[D2-D2](Fixed Length/1Byte/Lower/Upper Byte/No Swap)
6	Non-conversion Variable	Requested module I/O No.	[D3-D3](Fixed Length/2Byte/Lower/Upper Byte/No Swap)
7	Static Data	For future expansion	00(1Byte)
8	Length	Request data length	[Object element9-14/HEX/Reverse/2Byte]
9	Non-conversion Variable	Monitoring timer	[D4-D4](Fixed Length/2Byte/Lower/Upper Byte/No Swap)
10	Static Data	Command	0104(2Byte)
11	Static Data	Subcommand	0000(2Byte)
12	Non-conversion Variable	Head device No.	[D5-D5](Fixed Length/3Byte/Lower/Upper Byte/No Swap)
13	Non-conversion Variable	Device code	[D7-D7](Fixed Length/1Byte/Lower/Upper Byte/No Swap)

Change Type | Add New | Copy | Paste | Delete

Close

- Normal response

Packet Setting

Protocol No. Protocol Name

Packet Type Packet Name

Packet No.

Element List

Element No.	Element Type	Element Name	Element Setting
1	Static Data	(Fixed data)	D400(2Byte)
2	Non-conversion Variable	Serial No.	[D9-D9](Fixed Length/2Byte/Lower/Upper Byte/No Swap)
3	Static Data	(Fixed data)	0000(2Byte)
4	Non-conversion Variable	Network No.	[D10-D10](Fixed Length/1Byte/Lower/Upper Byte/No Swap)
5	Non-conversion Variable	Station No.	[D11-D11](Fixed Length/1Byte/Lower/Upper Byte/No Swap)
6	Non-conversion Variable	Requested module I/O No.	[D12-D12](Fixed Length/2Byte/Lower/Upper Byte/No Swap)
7	Static Data	For future expansion	00(1Byte)
8	Length	Response data length	[Object element9-10/HEX/Reverse/2Byte]
9	Static Data	End code	0000(2Byte)
10	Non-conversion Variable	Response data	[D13][D14-D973](Variable Length/1920Byte/Lower/Upper Byte/No Swap)

Change Type | Add New | Copy | Paste | Delete

Close

- Error response

Packet Setting

Protocol No. Protocol Name

Packet Type Packet Name

Packet No.

Element List

Element No.	Element Type	Element Name	Element Setting
1	Static Data	(Fixed data)	D400(2Byte)
2	Non-conversion Variable	Serial No.	[D974-D974](Fixed Length/2Byte/Lower/Upper Byte/No Swap)
3	Static Data	(Fixed data)	0000(2Byte)
4	Non-conversion Variable	Network No.	[D975-D975](Fixed Length/1Byte/Lower/Upper Byte/No Swap)
5	Non-conversion Variable	Station No.	[D976-D976](Fixed Length/1Byte/Lower/Upper Byte/No Swap)
6	Non-conversion Variable	Requested module I/O No.	[D977-D977](Fixed Length/2Byte/Lower/Upper Byte/No Swap)
7	Static Data	For future expansion	00(1Byte)
8	Length	Response data length	[Object element9-15/HEX/Reverse/2Byte]
9	Non-conversion Variable	End code	[D978-D978](Fixed Length/2Byte/Lower/Upper Byte/No Swap)
10	Non-conversion Variable	Network No.	[D979-D979](Fixed Length/1Byte/Lower/Upper Byte/No Swap)
11	Non-conversion Variable	Station No.	[D980-D980](Fixed Length/1Byte/Lower/Upper Byte/No Swap)
12	Non-conversion Variable	Requested module I/O No.	[D981-D981](Fixed Length/2Byte/Lower/Upper Byte/No Swap)
13	Static Data	For future expansion	00(1Byte)

Change Type | Add New | Copy | Paste | Delete

Close

10. Write the protocol setting data to the CPU module.

 [Online] ⇄ [Write to Module]

Module Write

Target Module Selection

Module Selection

Target Memory

Please save in the protocol setting file because the data to be written to target memory does not include the following information.

[Non-written Data in Target Memory]
 Manufacturer
 Packet Name
 Protocol Detailed Setting Type, Version, Explanation
 Packet Setting Configuration Element Name

Execute | Cancel

11. Write the set parameters to the CPU module. Then reset the CPU module or power off and on the system.

 [Online] ⇄ [Write to PLC]

Receiving side

1. Set the CPU module and add the module labels of the CPU module. The setting method of the CPU module and addition method of the module label are the same as those of when setting the sending side. (☞ Page 52 Sending side)
2. Set the "Basic Settings" in the following.

☞ Navigation window ⇒ [Parameter] ⇒ [FX5UCPU] ⇒ [Module Parameter] ⇒ [Ethernet Port] ⇒ [Basic Settings]

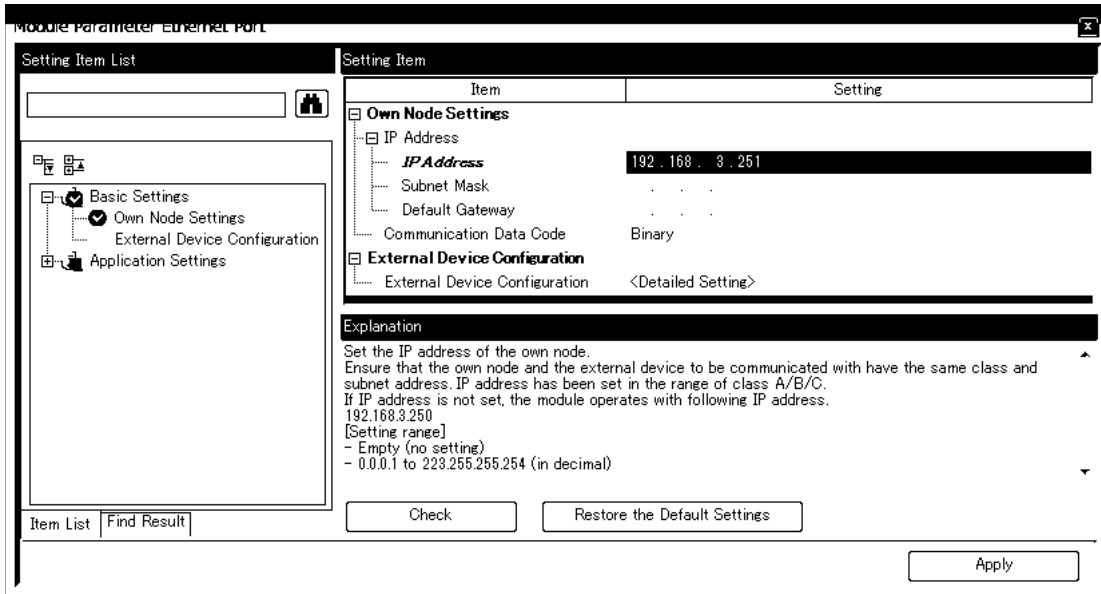

3. Set the external device configuration in the following.

☞ Navigation window ⇒ [Parameter] ⇒ [FX5UCPU] ⇒ [Module Parameter] ⇒ [Ethernet Port] ⇒ [Basic Settings] ⇒ [External Device Configuration]

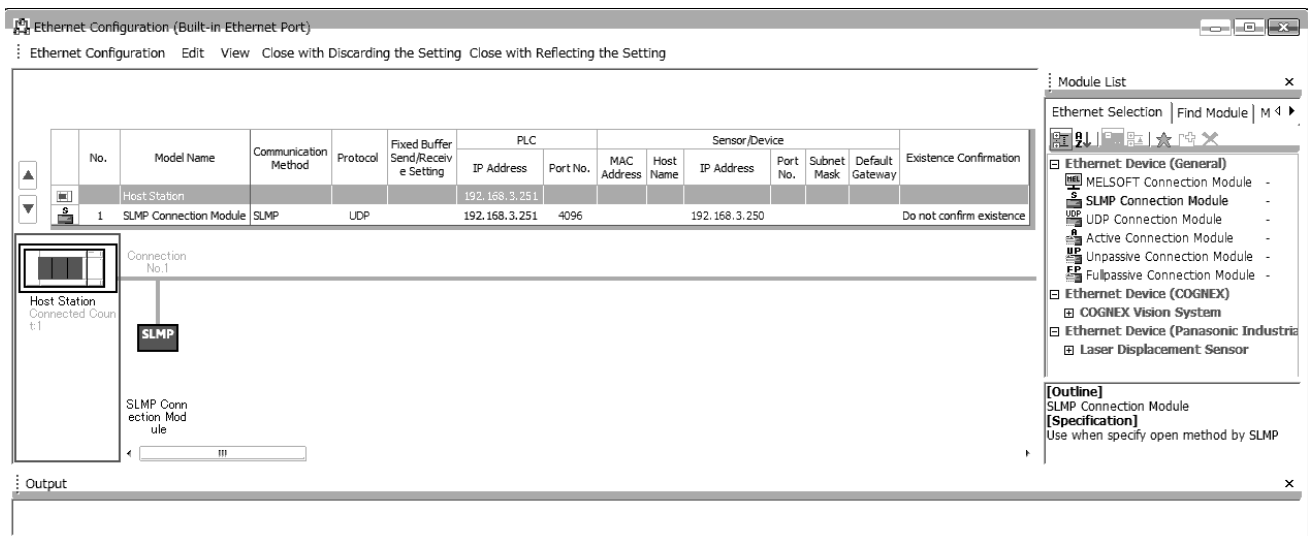

4. Write the set parameters to the CPU module. Then reset the CPU module or power off and on the system.

☞ [Online] ⇒ [Write to PLC]

6.6 Predefined Protocol Support Function Instruction

Executing the registered protocols

SP.ECPRTCL

This instruction executes the communication protocol registered using the engineering tool.

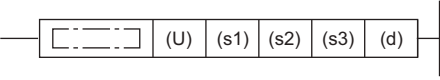
Ladder diagram	Structured text
	<pre>ENO:=SP_ECPRTCL(EN,U0,s1,s2,s3,d);</pre>

FBD/LD

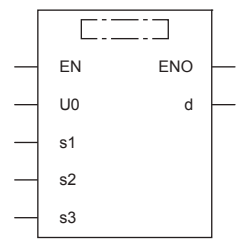

("SP_ECPRTCL" enters .)

Setting data

■ Descriptions, ranges, and data types

Operand	Description	Range	Data type	Data type (label)
(U)*1	Dummy (Input the character string [U0].)	—	Character string	ANYSTRING_SINGLE
(s1)	Connection number	1 to 8	16-bit unsigned binary	ANY16
(s2)	Number of protocols to be executed continuously	1 to 8	16-bit unsigned binary	ANY16
(s3)	Head device number for storing the control data	Refer to Control data (Page 59)	Word	ANY16_ARRAY (Number of elements: 18)
(d)	Head device number which turns ON when the execution of the instruction is completed and remains on for 1 scan. If the instruction is completed with an error, (d)+1 is also turned on.	—	Bit	ANYBIT_ARRAY (Number of elements: 2)

*1 In the case of the ST language and the FBD/LD language, U displays as U0.

■ Applicable devices

Operand	Bit	Word			Double word		Indirect specification	Constant			Others
	X, Y, M, L, SM, F, B, SB, S	T, ST, C, D, W, SD, SW, R	U□\G□	Z	LC	LZ		K, H	E	\$	
(U)	—	○	—	—	—	—	○	—	—	○	—
(s1)	○	○	—	—	—	—	○	○	—	—	—
(s2)	○	○	—	—	—	—	○	○	—	—	—
(s3)	○	○	—	—	—	—	○	—	—	—	—
(d)	○	○*1	—	—	—	—	—	—	—	—	—

*1 T, ST, C cannot be used.

Control data

Device	Item	Description	Setting range	Set by*1
(s3)+0	Resulting number of executed protocols	The number of protocols executed by the SP.ECPRTCL instruction is stored. Any protocol where an error occurred is also included in the execution number. If the setting of setting data or control data contains an error, "0" is stored.	0, 1 to 8	System
(s3)+1	Completion status	The completion status is stored upon completion of the instruction. When two or more protocols are executed, the execution result of the protocol executed last is stored. <ul style="list-style-type: none"> • 0: Normal completion • Other than 0: Error completion (error code) 	—	
(s3)+2	Execution protocol number 1	Specify the number of the protocol to be executed first.	1 to 64	User
(s3)+3	Execution protocol number 2	Specify the number of the protocol to be executed second.	0, 1 to 64	
(s3)+4	Execution protocol number 3	Specify the number of the protocol to be executed third.	0, 1 to 64	
(s3)+5	Execution protocol number 4	Specify the number of the protocol to be executed fourth.	0, 1 to 64	
(s3)+6	Execution protocol number 5	Specify the number of the protocol to be executed fifth.	0, 1 to 64	
(s3)+7	Execution protocol number 6	Specify the number of the protocol to be executed sixth.	0, 1 to 64	
(s3)+8	Execution protocol number 7	Specify the number of the protocol to be executed seventh.	0, 1 to 64	
(s3)+9	Execution protocol number 8	Specify the number of the protocol to be executed eighth.	0, 1 to 64	
(s3)+10	Collation match Receive packet number 1	If receiving is included in the communication type of the protocol that has been executed first, the receive packet number successful in collation match is stored. If the communication type is "receive only", "0" is stored. If an error occurs during execution of the first protocol, "0" is stored.	0, 1 to 16	System
(s3)+11	Collation match Receive packet number 2	If receiving is included in the communication type of the protocol that has been executed second, the receive packet number successful in collation match is stored. If the communication type is "receive only", "0" is stored. If an error occurs during execution of the second protocol, "0" is stored. If the number of protocols executed is less than 2, "0" is stored.	0, 1 to 16	
(s3)+12	Collation match Receive packet number 3	If receiving is included in the communication type of the protocol that has been executed third, the receive packet number successful in collation match is stored. If the communication type is "receive only", "0" is stored. If an error occurs during execution of the third protocol, "0" is stored. If the number of protocols executed is less than 3, "0" is stored.	0, 1 to 16	
(s3)+13	Collation match Receive packet number 4	If receiving is included in the communication type of the protocol that has been executed fourth, the receive packet number successful in collation match is stored. If the communication type is "receive only", "0" is stored. If an error occurs during execution of the fourth protocol, "0" is stored. If the number of protocols executed is less than 4, "0" is stored.	0, 1 to 16	
(s3)+14	Collation match Receive packet number 5	If receiving is included in the communication type of the protocol that has been executed fifth, the receive packet number successful in collation match is stored. If the communication type is "receive only", "0" is stored. If an error occurs during execution of the fifth protocol, "0" is stored. If the number of protocols executed is less than 5, "0" is stored.	0, 1 to 16	
(s3)+15	Collation match Receive packet number 6	If receiving is included in the communication type of the protocol that has been executed sixth, the receive packet number successful in collation match is stored. If the communication type is "receive only", "0" is stored. If an error occurs during execution of the sixth protocol, "0" is stored. If the number of protocols executed is less than 6, "0" is stored.	0, 1 to 16	
(s3)+16	Collation match Receive packet number 7	If receiving is included in the communication type of the protocol that has been executed seventh, the receive packet number successful in collation match is stored. If the communication type is "receive only", "0" is stored. If an error occurs during execution of the seventh protocol, "0" is stored. If the number of protocols executed is less than 7, "0" is stored.	0, 1 to 16	
(s3)+17	Collation match Receive packet number 8	If receiving is included in the communication type of the protocol that has been executed eighth, the receive packet number successful in collation match is stored. If the communication type is "receive only", "0" is stored. If an error occurs during execution of the eighth protocol, "0" is stored. If the number of protocols executed is less than 8, "0" is stored.	0, 1 to 16	

*1 The "Set by" column indicates the following.
 User: The data must be set before executing the SP.ECPRTCL instruction.
 System: The CPU module stores the execution result of the instruction.

Processing details

This instruction executes the protocol registered using the engineering tool. Using the connection specified by (s1), the instruction executes the protocol in accordance with the control data stored in the device specified by (s3) and later. The instruction continuously executes as many protocols as specified by (s2) (a maximum of 8 protocols) at one time.

The number of executed protocols is stored in the device specified by (s3)+0.

The completion of the SP.ECPRTCL instruction can be checked using the completion devices (d)+0 and (d)+1.

- Completion device (d)+0: Turns ON during the END processing for the scan in which the SP.ECPRTCL instruction is completed, and turns OFF during the next END processing.
- Completion device (d)+1: Turns ON or OFF depending on the status when the SP.ECPRTCL instruction is completed.

Status	Description
When completed normally	The device does not change (remains OFF).
When completed with an error	The device turns ON during the END processing for the scan in which the SP.ECPRTCL instruction is completed, and turns OFF during the next END processing.

- The following figure shows the SP.ECPRTCL instruction execution timing.

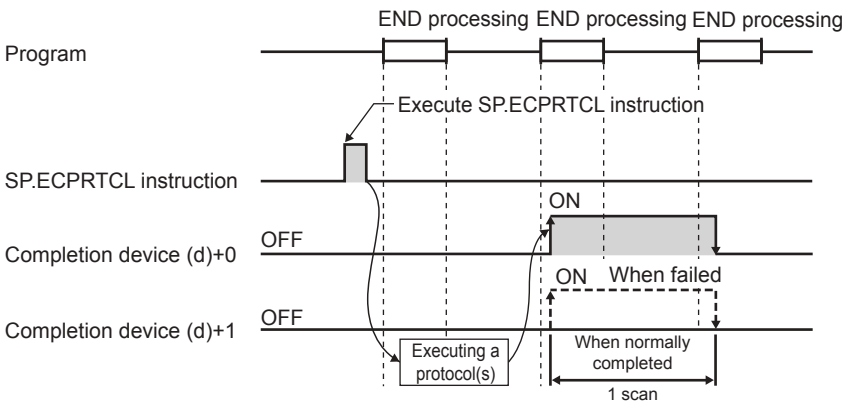

- Protocol execution can be canceled by setting a protocol cancel request. The protocol cancel request is specified in the predefined protocol support function execution status check area (SD10740 to SD10899).

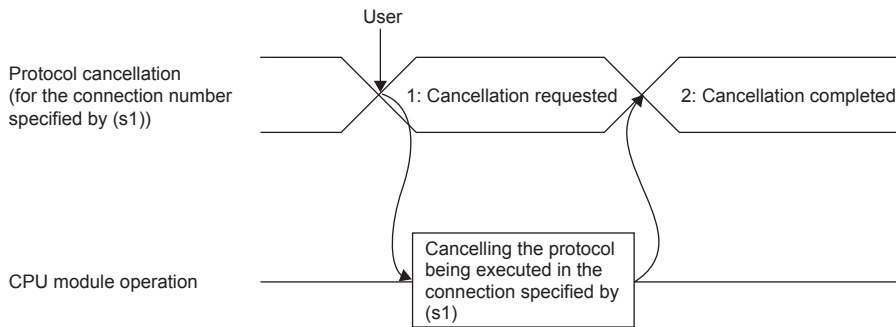

• The following figure shows the protocol cancel operations timing.

■ If a cancel request is issued before transmission

The following figure shows the operation when the protocol execution status is "1: Waiting for transmission".

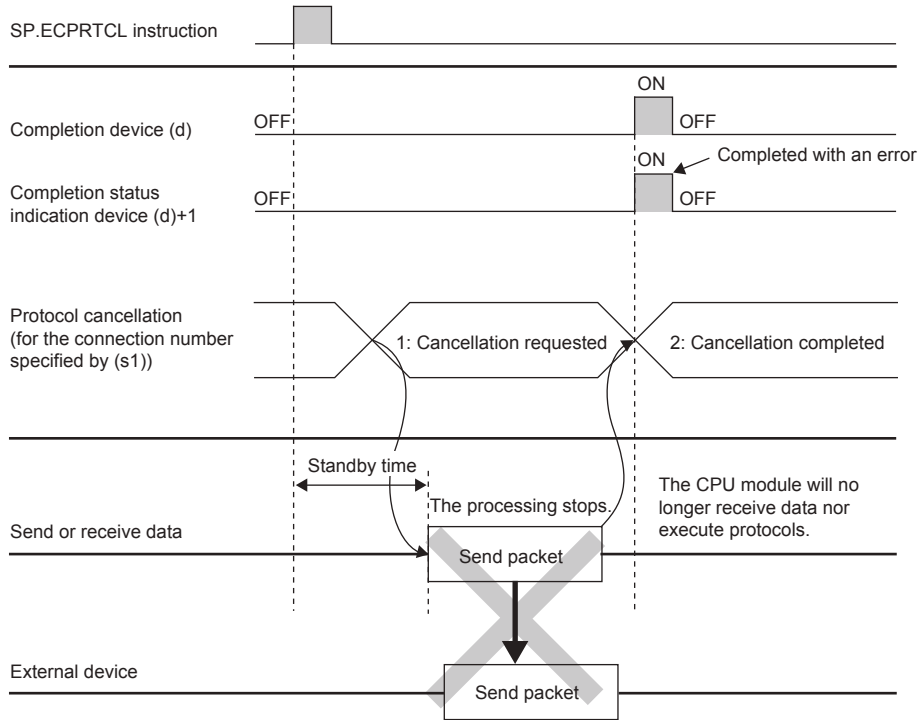

■ If a cancel request is issued before completion of transmission

The following figure shows the operation when transmission has not been completed while the protocol execution status is "2: Sending".

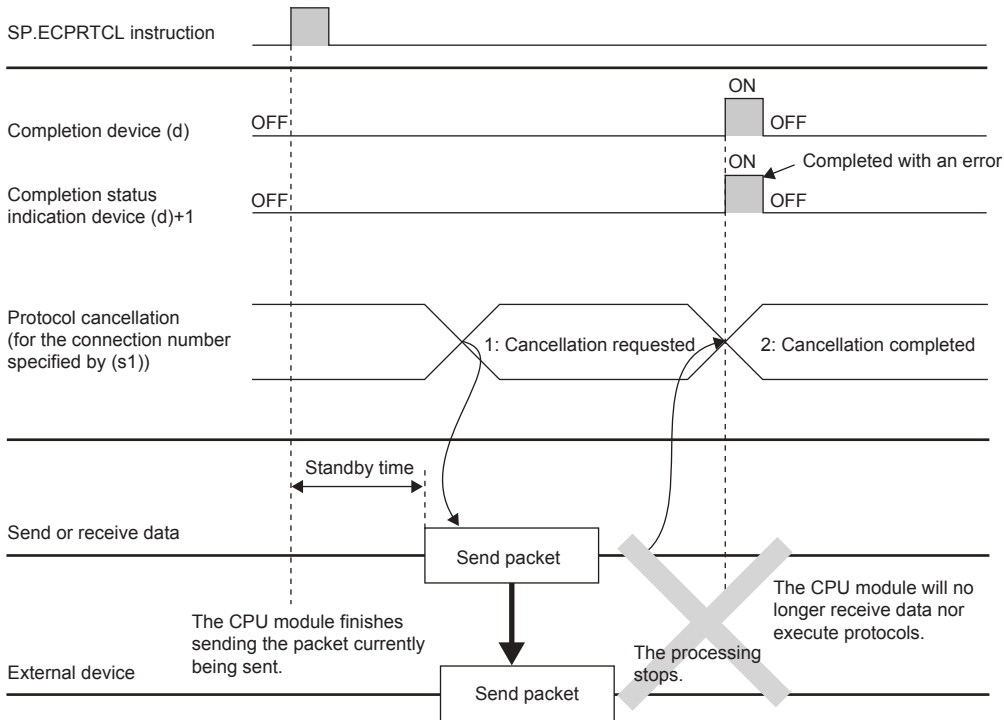

■ If a cancel request is issued upon completion of transmission

The following figure shows the operation when transmission has been completed while the protocol execution status is "2: Sending".

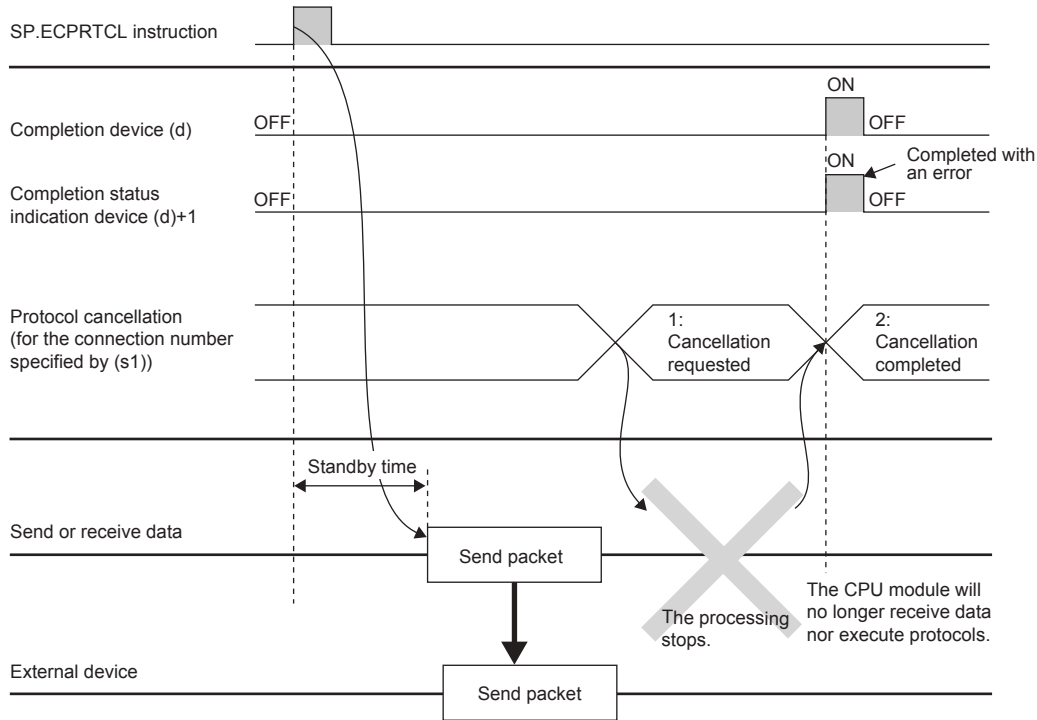

■ If a cancel request is issued while waiting for reception

The following figure shows the operation when the protocol execution status is "3: Waiting for data reception".

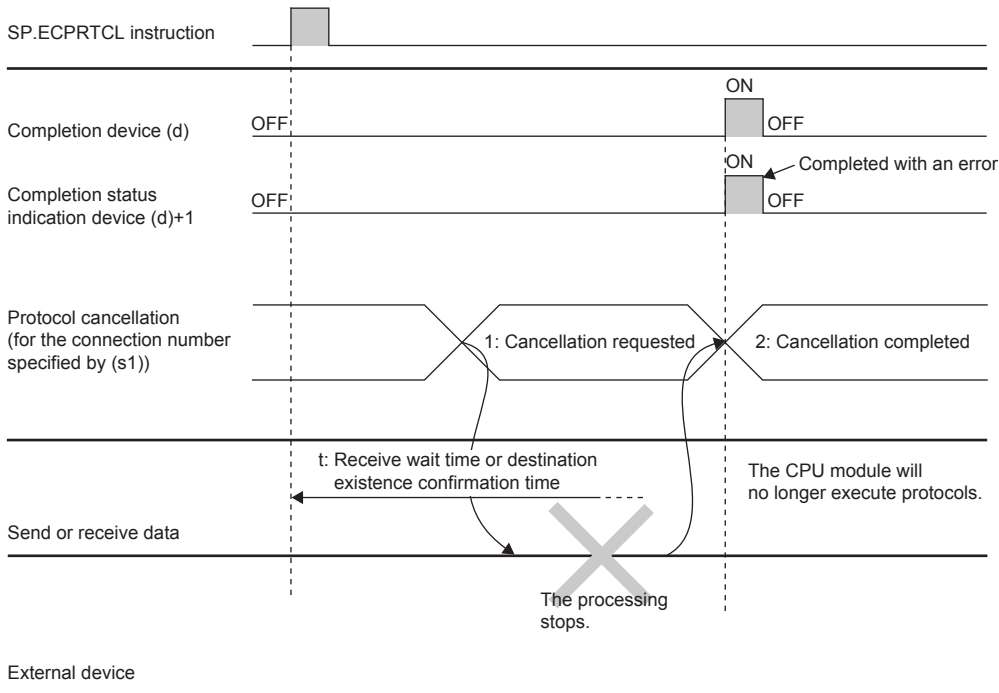

■ If a cancel request is issued during receiving

The following figure shows the operation when the protocol execution status is "4: Receiving".

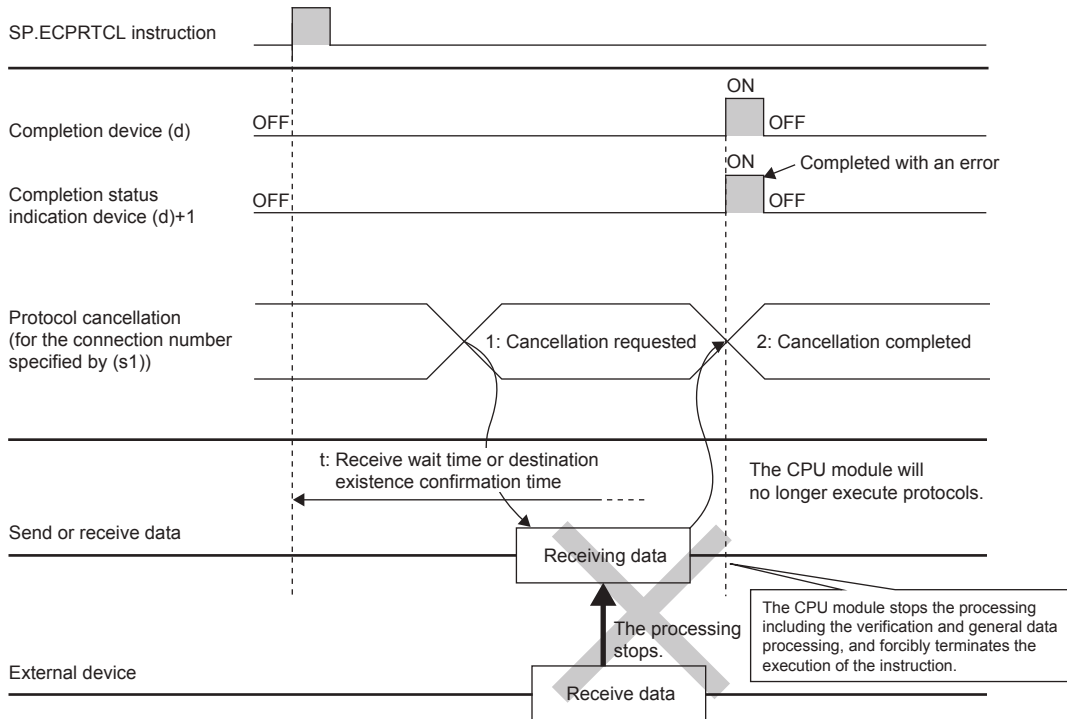

Precautions

- If an error occurs in the mth protocol while multiple protocols are being executed, the instruction does not execute the "m+1"th protocol and after and is completed with an error.
- The connections for which the SP.ECPRTCL instruction can be executed are only those for which "Communication protocol" is specified for the communication means.
- If a cancel request is received during execution of the mth protocol while multiple protocols are executed continuously, following is stored in (s3).

Device	Item	Description
(s3)+0	Resulting number of executed protocols	The executed protocol number.
(s3)+1	Completion status	The error codes.
(s3)+10	Collation match Receive packet number 1	The receive packet number successful in collation match for the already executed protocol.
⋮	⋮	
(s3)+m+8	Collation match Receive packet number m-1	

- If same instructions are executed for the same connection, the subsequent instruction is ignored and is not executed until the preceding instruction is completed.
- The SP.ECPRTCL instruction itself does not open/close a connection and therefore the SP.SOCOPEN/SP.SOCLOSE instructions need to be used to open/close the connection.

☞ Refer to the Page 77 SP.SOCOPEN and Page 81 SP.SOCLOSE

Operation error

Error code (SD0/SD8067)	Description
2820H	The device used exceeded the specified range.
2821H	The device used to store data are overlapping.
2822H	Device that cannot be specified is specified.
3405H	The input data was out of range.

7 SOCKET COMMUNICATION FUNCTION

The socket communication function allows data communication with the devices on Ethernet by TCP or UDP using various dedicated instructions.

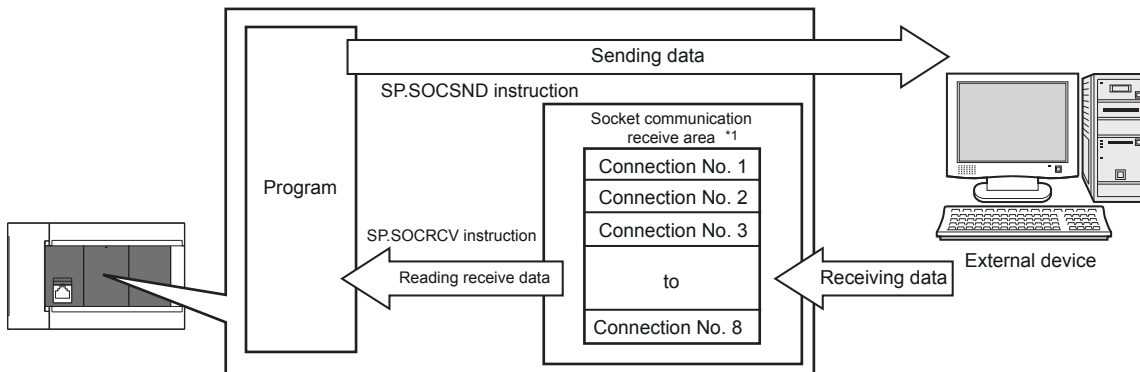

*1 The area is used for storing data received from the connected open devices.

Point

- For dedicated instructions used for the socket communication function, refer to [Page 76 Socket Communication Function Instructions](#).
- Access through routers is also available. When configuring the settings set the subnet mask pattern and default gateway IP address. ([Page 24 Communication via Router](#))

Port numbers

In socket communication, port numbers are used to identify respective communication and thereby multiple communications are available both on TCP and UDP.

- For sending: Specify the port number of the CPU module from which data is sent, and the port number of the destination device.
- For receiving: Specify the port number of the CPU module, and read the data sent to the port.

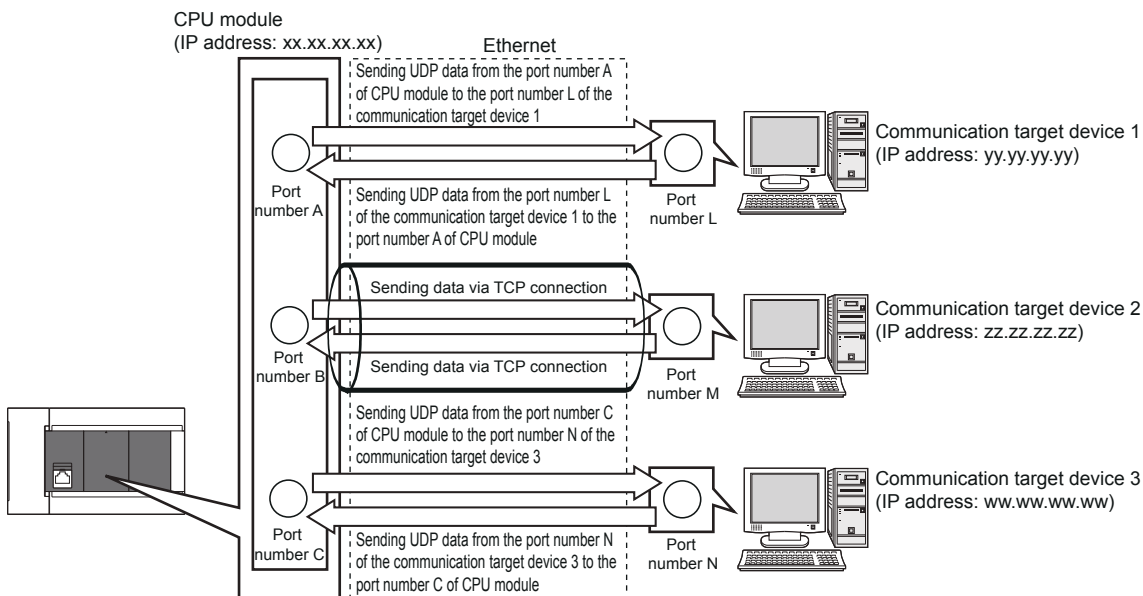

7.1 Communication Using TCP

TCP (Transmission Control Protocol) establishes a connection to a device with a port number, and performs reliable data communication.

To perform socket communication using TCP, confirm the following in advance.

- IP address and port number of the target device
- IP address and port number of the CPU module
- Which side will open a connection, the target device or CPU module? (Active open or Passive open)

TCP connection

There are two types of open operation for TCP connection: Active open and Passive open.

Firstly, the device waiting for a TCP connection performs a Passive open at the specified port.

The other device performs an Active open by specifying the port number of the device which is waiting in Passive open state.

Through the above process, a TCP connection is established and communication is available.

■Active open

Active open is a TCP connection method, which actively opens a connection to the device that is passively waiting for a TCP connection.

■Passive open

The following two types of Passive open methods are available for TCP connection.

TCP connection method	Description
Unpassive	Allows a connection regardless of the IP address and port number of the connected device. (The IP address and port number of the device connected can be acquired using the SP.SOCCINF instruction.)
Fullpassive	Allows a connection to the device only when the specified IP address and port number are met. A connection made by another device that does not have the specified IP address and port number is automatically disconnected before communication.

Point

The expressions of Active and Passive opens may vary according to the device.

- Active open: TCP connection initiating device, client, connecting side, etc.
- Passive open: TCP connection waiting device, server, listening side, etc.

Program example for Active open

The following shows the communication flow of an Active open.

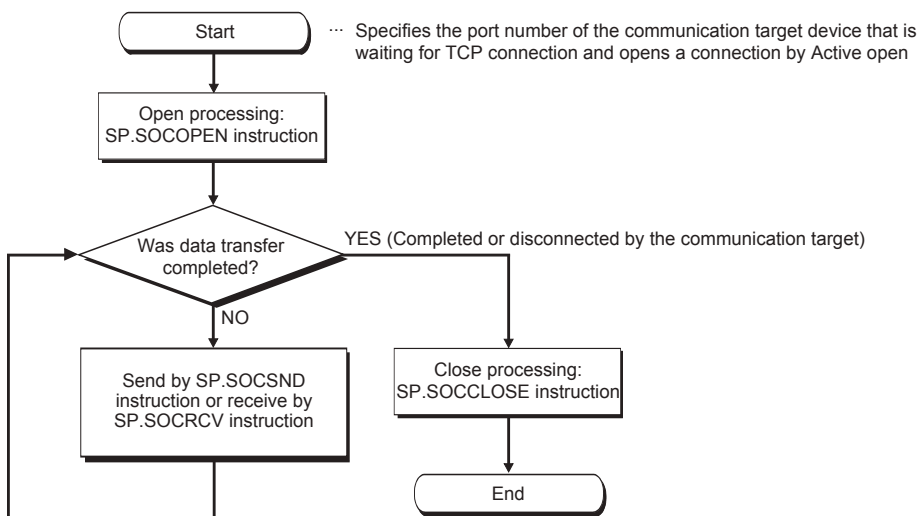

Parameter setting

The following parameters are set for the sample program.

Navigation window ⇒ [Parameter] ⇒ [FX5UCPU] ⇒ [Module Parameter] ⇒ [Ethernet Port] ⇒ [Basic Settings] ⇒ [External Device Configuration] ⇒ [Detailed Setting] ⇒ [Ethernet Configuration (Built-in Ethernet Port)] screen

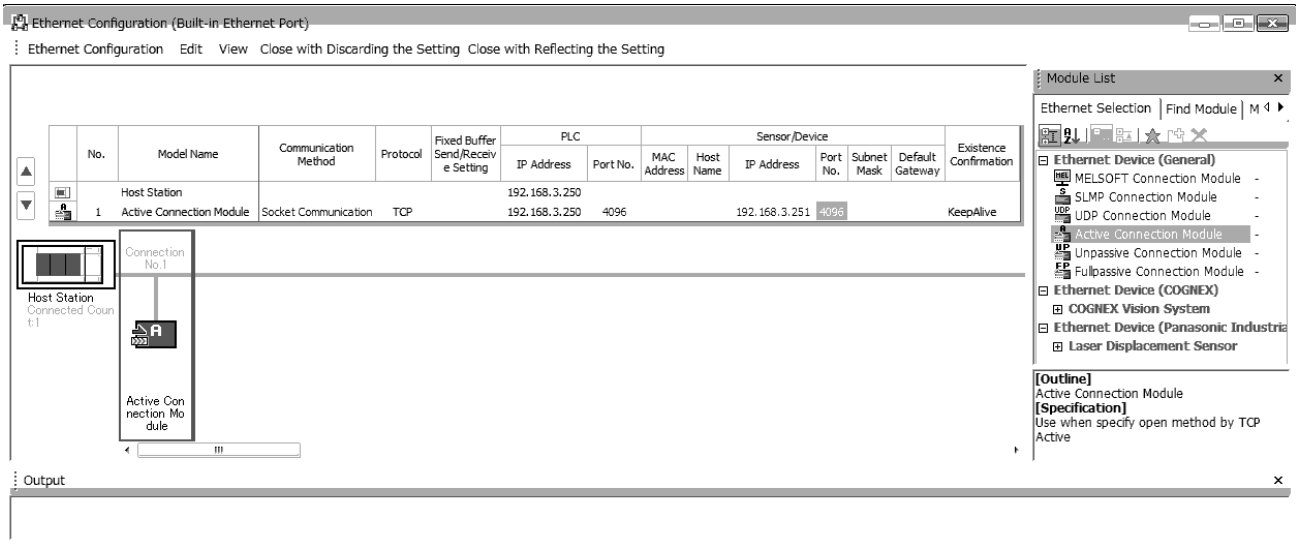

- Drag and drop the "Active Connection Module" from "Module List" to the left side on the window. Execute the settings as mentioned below.

Item		Description
PLC	Port No.	4096 (Setting range: 1 to 4999, 5010 to 65534) Do not specify 5000 to 5009 because these ports are used by the system.
Sensor/Device	IP Address	192.168.3.251 (Setting range: 0.0.0.1 to 223.255.255.254)
	Port No.	4096 (Setting range: 1 to 65534)

■Devices used in the sample program

The following table lists the device numbers used in the sample program and their applications.

Device No.	Application
M1000	Open instruction
D100 to D109	SP.SOCOPEN instruction control data
M100 and M101	SP.SOCOPEN instruction completion device
M1002	Normal open indication
M1003	Open error indication
M3000	Send instruction
D3000 and D3001	SP.SOCSND instruction control data
M300 and M301	SP.SOCSND instruction completion device
D300 to D303	Send data length and send data (6 bytes of 12H, 34H, 56H, 78H, 9AH, BCH)
M3002	Normal send indication
M3003	Send error indication
M4000	Close instruction
M4001	Disconnection by the other device
SD10680	Open completion signal
SD10681	Open request signal
SD10682	Receive state signal
D200 and D201	SP.SOCCLOSE instruction control data
M200 and M201	SP.SOCCLOSE instruction completion device
M4002	Normal close indication
M4003	Close error indication
M4004	Closing flag
D5000 and D5001	SP.SOCRCV instruction control data
M500 and M501	SP.SOCRCV instruction completion device
D500 and higher	Received data length and received data
M5002	Normal receive indication
M5003	Receive error indication

Sample program

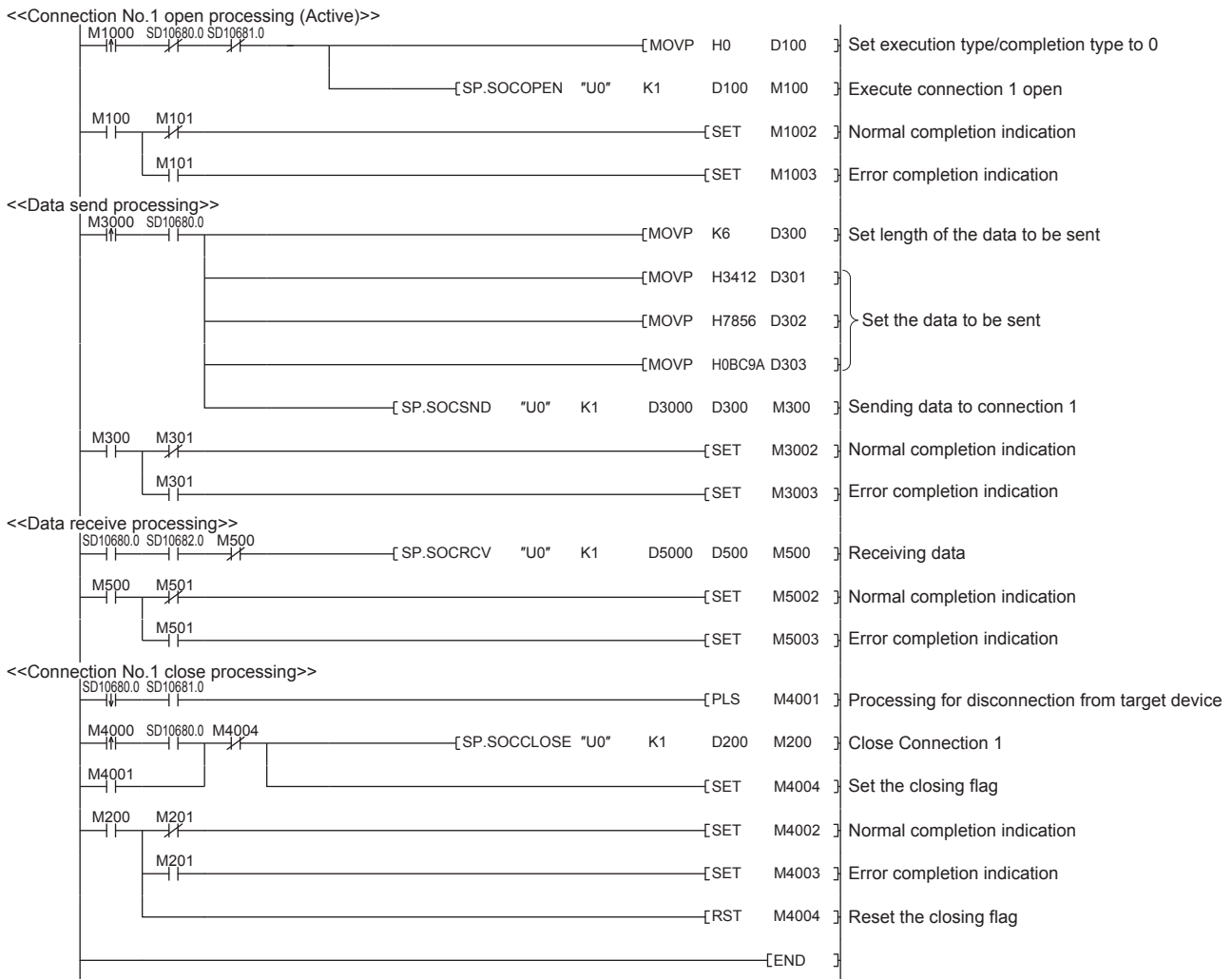

Precautions for Active open communication

Configure an interlock circuit using the Open completion signal (SD10680.n) and Open request signal (SD10681.n) in the program.

The following chart shows on/off timings of the Open completion signal and Open request signal.

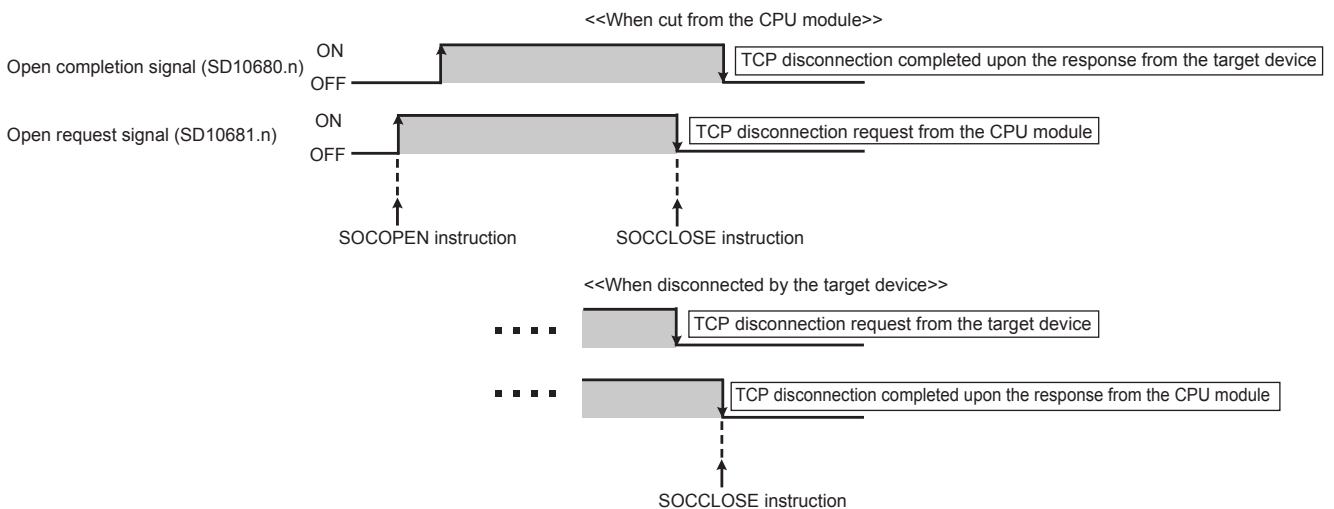

Program example for Passive open

The following shows the communication flow of a Passive open.

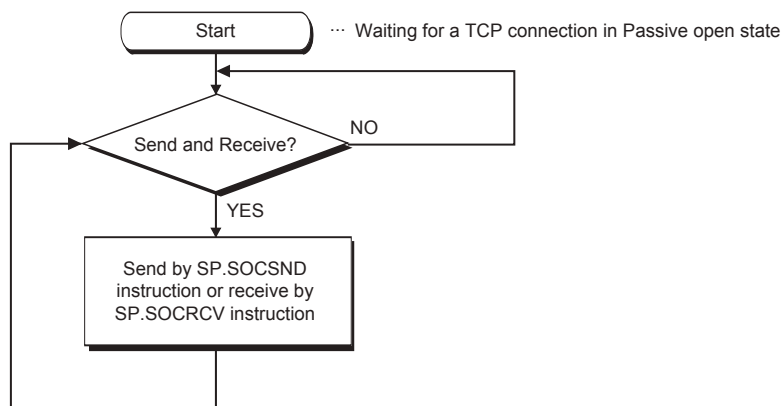

Parameter setting

The following parameters are set for the sample program.

Navigation window ⇒ [Parameter] ⇒ [FX5UCPU] ⇒ [Module Parameter] ⇒ [Ethernet Port] ⇒ [Basic Settings] ⇒ [External Device Configuration] ⇒ [Detailed Setting] ⇒ [Ethernet Configuration (Built-in Ethernet Port)] screen

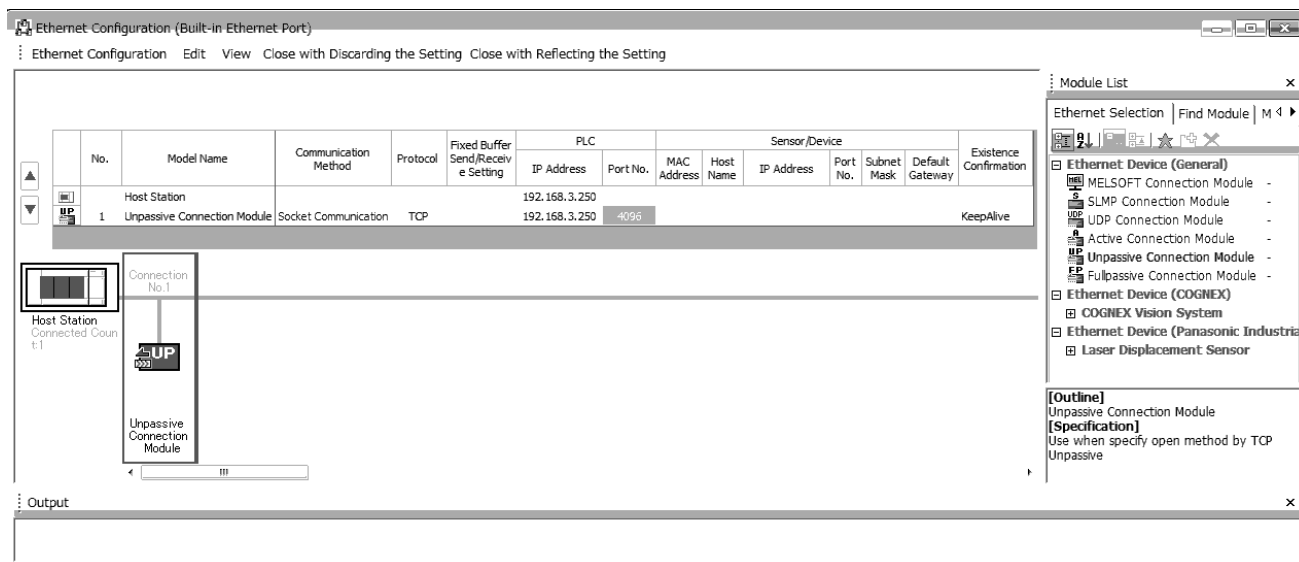

- Drag and drop the "Unpassive Connection Module" or "Fullpassive Connection Module" from "Module List" to the left side on the window. Execute the settings as mentioned below.

Item	Description	
PLC	Port No.	4096 (Setting range: 1 to 4999, 5010 to 65534) Do not specify 5000 to 5009 because these ports are used by the system.
Sensor/Device	IP Address	Blank When "General Socket Fullpassive Connection Module" is selected, a value must be set. (Setting range: 0.0.0.1 to 223.255.255.254)
	Port No.	Blank When "General Socket Fullpassive Connection Module" is selected, a value must be set. (Setting range: 1 to 65534)

■Devices used in the sample program

The following table lists the device numbers used in the sample program and their applications.

Device No.	Application
M3000	Send instruction
D3000 and D3001	SP.SOCSND instruction control data
M300 and M301	SP.SOCSND instruction completion device
D300 to D303	Send data length and send data (6 bytes of 12H, 34H, 56H, 78H, 9AH, BCH)
M3002	Normal send indication
M3003	Send error indication
SD10680	Open completion signal
SD10682	Receive state signal
D5000 and D5001	SP.SOCRCV instruction control data
M500 and M501	SP.SOCRCV instruction completion device
D500 and higher	Received data length and received data
M5002	Normal receive indication
M5003	Receive error indication
D6000 and D6001	SP.SOCCINF instruction control data
D6010 to D6014	SP.SOCCINF instruction connection information

■Sample program

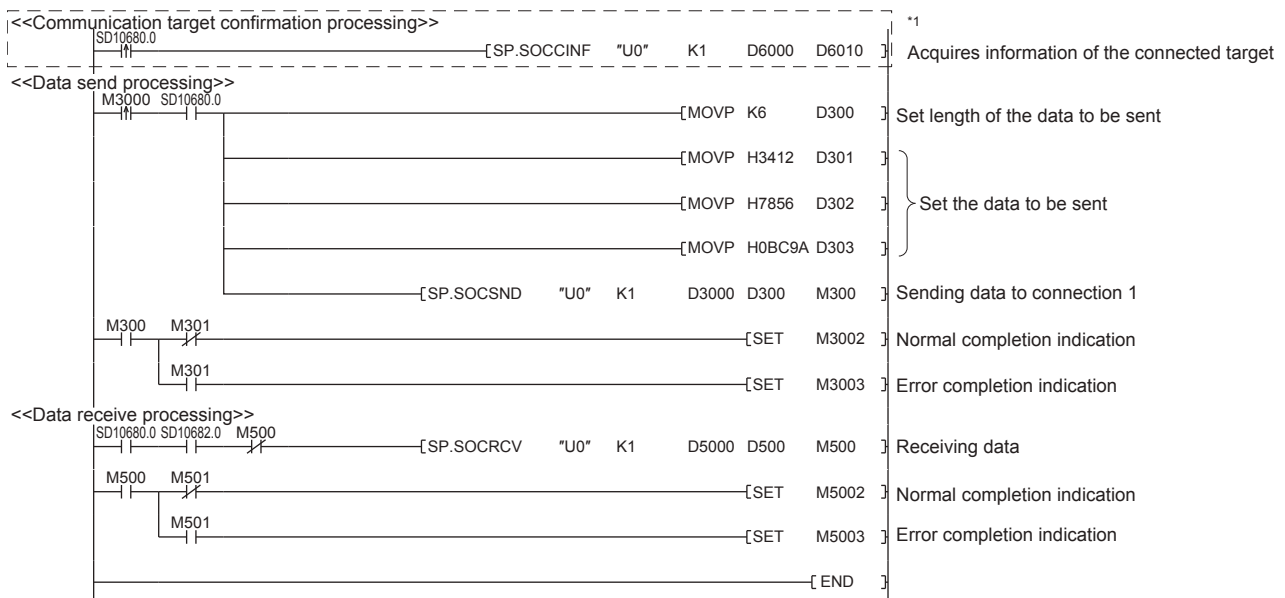

*1 For acquiring information of the device connected with TCP, run the program enclosed by the dotted line.
(It can be omitted when the information acquisition is not needed.)

■Precautions for Passive open communication

- Configure an interlock circuit using the Open completion signal (SD10680.n) and Open request signal (SD10681.n) in the program. The following chart shows on/off timings of the Open completion signal and Open request signal.

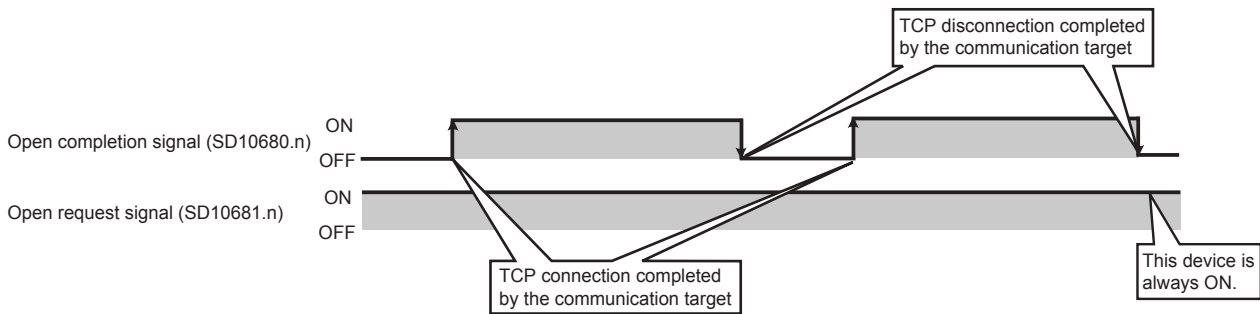

- When a device establishes a connection by Passive open, the IP address and port number of the connected device can be acquired using the SP.SOCCINF instruction.
- On TCP, one connection is established with one target device. To communicate with multiple devices from one port number, prepare the same number of connections as the number of target devices. A connection that exceeds the preset number of connections will be disconnected immediately.
- Do not accept a connection from a device until the CPU module is placed in the wait-for-open state. If a TCP connection request is received before entering the wait-for-open state after completion of CPU startup, the request will be recognized as an error, and a forced close message for the connection will be returned to the interfacing device. In this case, wait until the CPU state is changed to the wait-for-open state and then retry the connection from the device.
- Do not execute the SP.SOCCLOSE instruction in a program. Doing so will disable data transfer since the Open completion signal and Open request signal of the corresponding connection turn off for close processing. To reopen the closed connection, execute the SP.SOCOPEN instruction.

7.2 Communication Using UDP

UDP (User Datagram Protocol) is a simple protocol that does not perform data sequencing and retransmission. To perform socket communication using UDP, confirm the following in advance.

- IP address and port number of the target device
- IP address and port number of the CPU module

Program example

This section provides a program example for communication using UDP.

Parameter setting

Navigation window ⇒ [Parameter] ⇒ [FX5UCPU] ⇒ [Module Parameter] ⇒ [Ethernet Port] ⇒ [Basic Settings] ⇒ [External Device Configuration] ⇒ [Detailed Setting] ⇒ [Ethernet Configuration (Built-in Ethernet Port)] screen

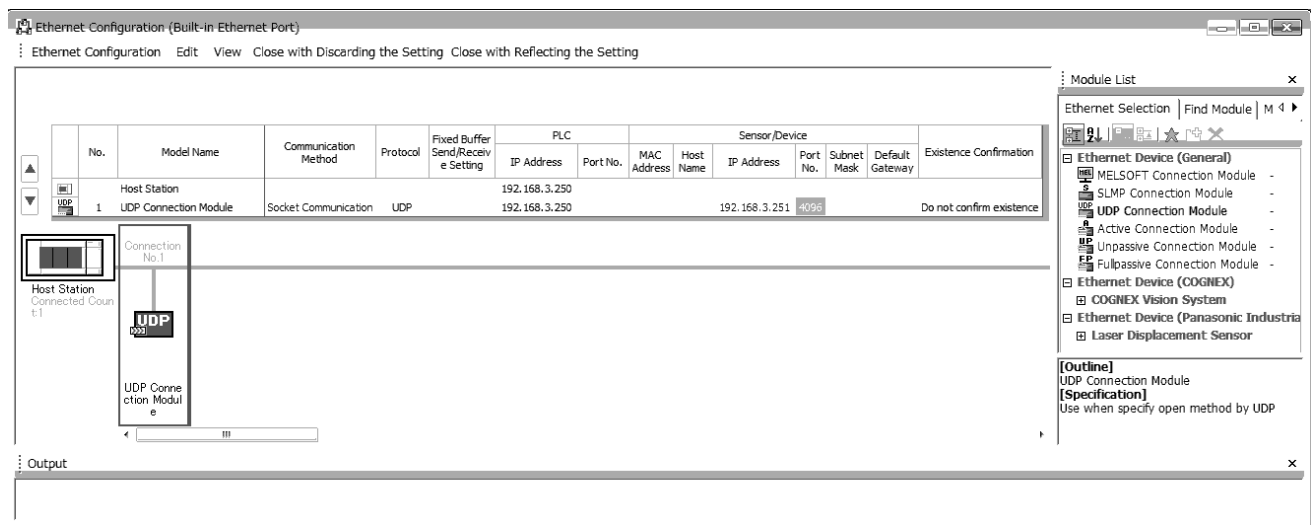

- Drag and drop the "UDP Connection Equipment" from "Module List" to the left side on the window. Execute the settings as mentioned below.

Item		Description
PLC	Port No.	4096 (Setting range: 1 to 4999, 5010 to 65534) Do not specify 5000 to 5009 because these ports are used by the system.
Sensor/Device	IP Address	192.168.3.251 (Setting range: 0.0.0.1 to 223.255.255.254/255.255.255.255)
	Port No.	4096 (Setting range: 1 to 65534)

■Devices used in the sample program

The following table lists the device numbers used in the sample program and their applications.

Device No.	Application
M3000	Send instruction
D3000 and D3001	SP.SOCSND instruction control data
M300 and M301	SP.SOCSND instruction completion device
D300 to D303	Receive data length and send data (6 bytes of 12H, 34H, 56H, 78H, 9AH, BCH)
M3002	Normal send indication
M3003	Send error indication
D5000 and D5001	SP.SOCRCV instruction control data
M500 and M501	SP.SOCRCV instruction completion device
SD10680	Open completion signal
SD10682	Receive state signal
M3001	Target change direction
D500 and higher	Receive data length and receive data
M5002	Normal receive indication
M5003	Receive error indication
D450 to D451	SP.SOCCINF instruction control data
D460 to D464	SP.SOCCINF instruction connection information

■Sample program

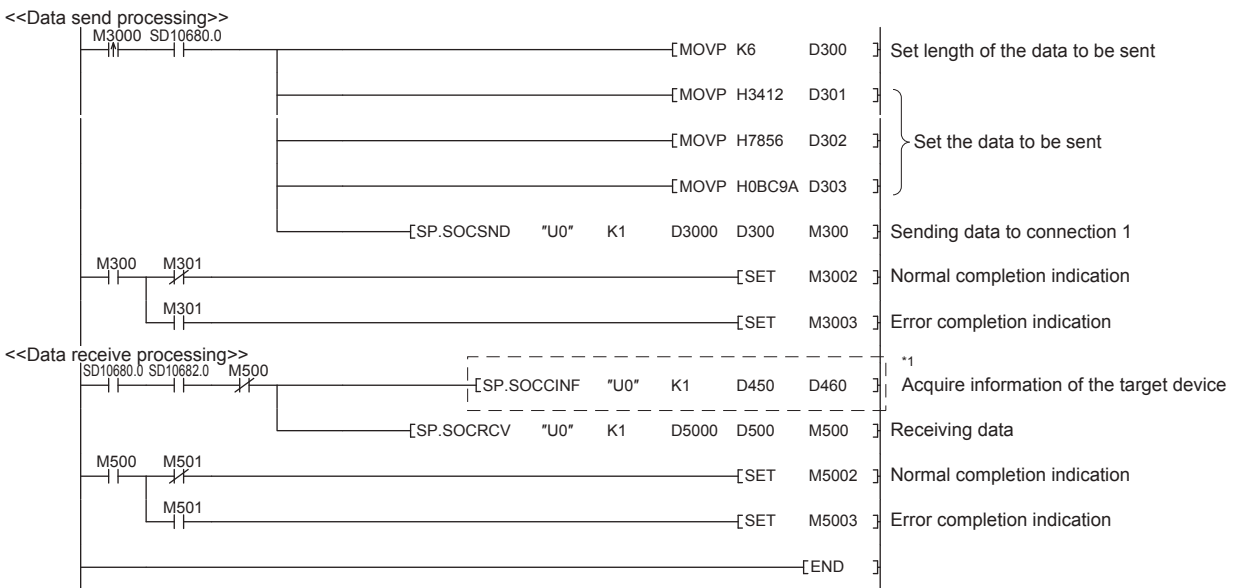

*1 For acquiring information of the target device connected on UDP, run the program enclosed by the dotted line.
(It can be omitted when the information acquisition is not needed.)

Precautions

■Use of UDP

Data may be lost, or may arrive out of order. Consider using TCP if any problem is expected.

■Sending and receiving data

Data sending process may complete normally even if the communication line between the CPU module and target device is not connected due to a reason such as cable disconnection. To avoid this, it is recommended to provide communication procedure at the user's discretion.

■Open completion signal and Open request signal

Once UDP is selected for a connection, the Open completion signal and Open request signal of the connection are always on.

■SP.SOCCLOSE instruction

Do not execute the SP.SOCCLOSE instruction in the program.

Doing so will disable data transfer since the Open completion signal and Open request signal of the corresponding connection turn off for close processing.

To reopen the closed connection, execute the SP.SOCOPEN instruction.

For the SP.SOCOPEN instruction, refer to  Page 77 Opening a connection.

7.3 Precautions

This section provides other precautions for the socket communication function.

Port number

Host station port number, 1 to 1023 (0001H to 03FFH), are assigned for reserved port numbers (WELL KNOWN PORT NUMBERS) and 61440 to 65534 (F000H to FFFEH) are for other communication functions. Therefore, using 1024 to 5548, 5570 to 61439 (0400H to 15ACH, 15C2H to EFFFH) is recommended.

Do not specify 5549 to 5569 (15ADH to 15C1H) because these ports are used by the system.

Do not specify 45237 (B0B5H) and 61440 to 65534 (F000H to FFFEH) for the socket communication function when using the iQ Sensor Solution-compatible function.

Reading received data

Read received data when the Receive state signal (SD10682.n) has turned on.

Communication via the built-in Ethernet port may be affected if a considerable amount of received data has not been read for a long time.

Conditions for closing

In TCP communication, even if no close request is sent from the connected device, the Open completion signal will turn off to close the connection in the following cases.

- Alive check is timed out.
- Forced close is received from the connected device.

Elements of TCP connection

The following four elements control TCP connections, and only one connection can be established with a unique setting for these elements. To use multiple TCP connections at the same time, at least one of the four elements must be different.

- IP address of the CPU module
- Port number of the CPU module
- IP address of the target device
- Port number of the target device

Reestablishment of the same connection

Allow 500 ms or more before reestablishing a connection of the same target IP address, the same host station port number, and the same target port number after closing it.

If the reestablishment is time-critical, it is recommended to change the host station port number on the Active open side.

Checking receive data length

Since no delimiter is provided for TCP communication data, separate data blocks that are sent continuously may be combined, or data sent all at once may be segmented, on the receiving end. The receive data length must be confirmed on the receiving end as necessary.

When receiving data on the target device, confirm the receive data length as shown below.

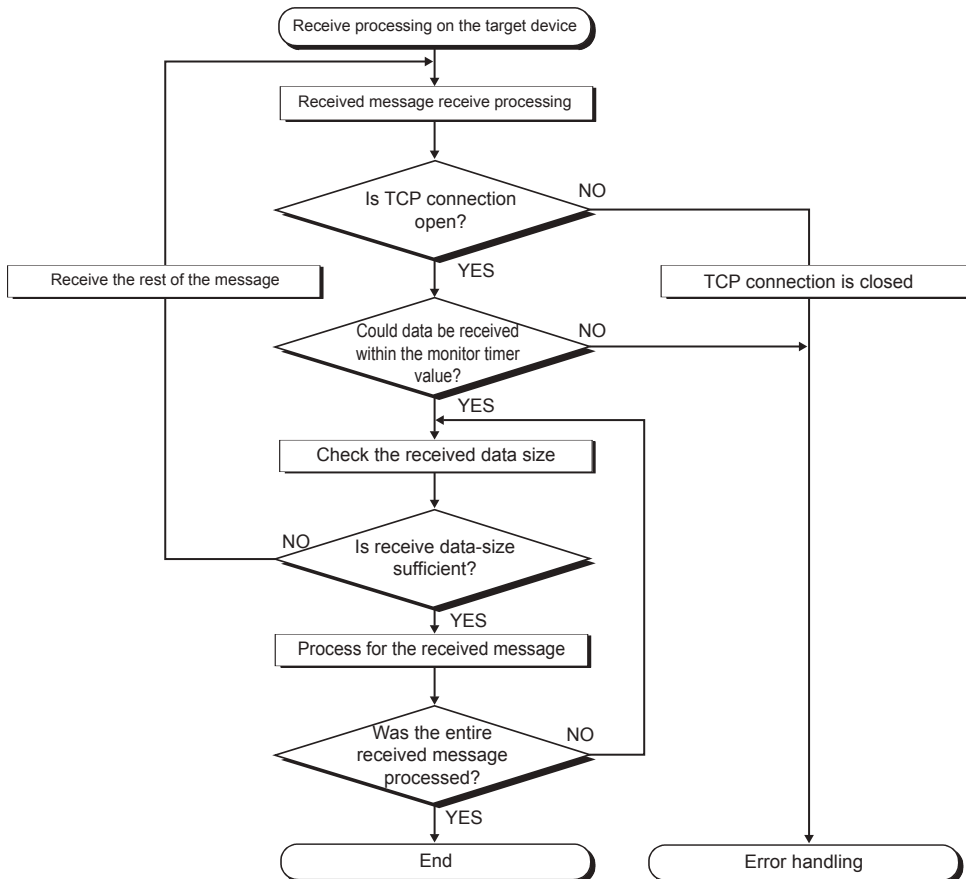





7.4 Socket Communication Function Instructions

The socket communication function instructions are provided for the CPU module to use the socket communication function. This section explains the socket communication function instructions.

The following is a list of the instructions.

Instruction	Description	Reference
SP.SOCOPEN	Establishes a connection.	Page 77 Opening a connection
SP.SOCCLOSE	Closes a connection.	Page 81 Disconnecting a connection
SP.SOCRCV	Reads the data received (Read at END processing).	Page 84 Reading received data in the END processing
SP.SOCSND	Sends data.	Page 87 Sending data
SP.SOCCINF	Reads connection information.	Page 90 Reading connection information
S(P).SOCRDATA	Reads data from the socket communication receive data area.	Page 92 Reading socket communication receive data

Point

- For configuration of data communication using the socket communication function, refer to  Page 65 Communication Using TCP and  Page 72 Communication Using UDP.
- If the instruction has a completion device, do not change any data, such as control data and request data, that are specified for the instruction until the execution of the instruction is completed.
- Do not execute any socket communication function instruction in an interrupt program.
- For error codes, refer to  Page 110 Error Codes or  MELSEC iQ-F FX5 User's Manual(Application).

Opening a connection

SP.SOCOPEN

Establishes a connection.

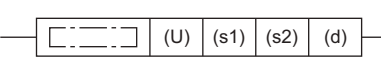
Ladder diagram	Structured text
	<pre>ENO:=SP_SOCOPEN(EN,U0,s1,s2,d);</pre>

FBD/LD

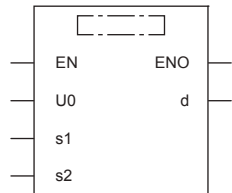

("SP_SOCOPEN" enters □.)

Setting data

■ Descriptions, ranges, and data types

Operand	Description	Range	Data type	Data type (Label)
(U) ^{*1}	Dummy (Input the character string ['U0'].)	—	Character string	ANYSTRING_SINGLE
(s1)	Connection number	1 to 8	16-bit unsigned binary	ANY16
(s2)	Start number of the device in which control data is stored	Refer to Control data (Page 78)	Word	ANY16_ARRAY (Number of elements: 10)
(d)	Start number of the device which turns on for one scan upon completion of the instruction. (d)+1 also turns on when failed.	—	Bit	ANYBIT_ARRAY (Number of elements: 2)

*1 In the case of the ST language and the FBD/LD language, U displays as U0.

■ Applicable devices

Operand	Bit	Word		Double word		Indirect specification	Constant			Others
	X, Y, M, L, SM, F, B, SB, S	T, ST, C, D, W, SD, SW, R	U□\G□	Z	LC		LZ	K, H	E	
(U)	—	—	—	—	—	—	—	—	○	—
(s1)	—	○	—	—	—	○	○	—	—	—
(s2)	—	○	—	—	—	○	—	—	—	—
(d)	○	○ ^{*1}	—	—	—	—	—	—	—	—

*1 T, ST, C cannot be used.

Processing details

This instruction opens a connection specified in (s1).

The set values used for the open processing is selected in (s2)+0.

The result of the SP.SOCOPEN instruction can be checked with the completion device, (d)+0 and (d)+1.

- Completion device (d)+0: Turns on in the END processing of the scan after completion of the SP.SOCOPEN instruction, and turns off in the next END processing.
- Completion device (d)+1: Turns on or off according to the status at the time of completion of the SP.SOCOPEN instruction.

Status	Description
When completed	Remains off.
When failed	Turns on in the END processing of the scan after completion of the SP.SOCOPEN instruction, and turns off in the next END processing.

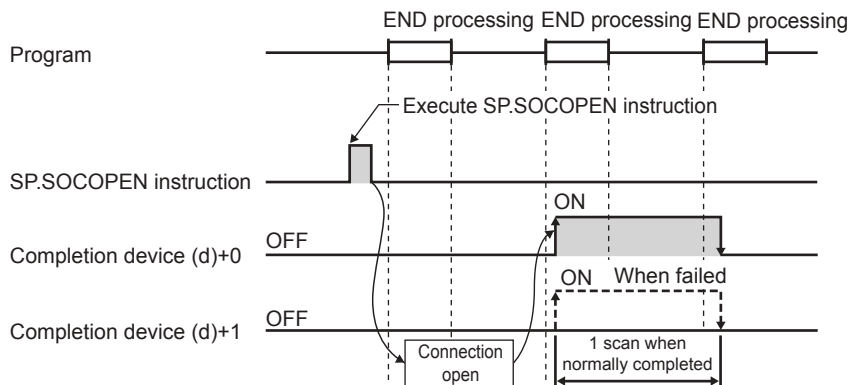

- A connection with no parameters (no protocol is specified) can be opened. In this case, specify 8000H for (s2)+0 and configure open settings in (s2)+2 to (s2)+9.

Operation error

Error code (SD0/SD8067)	Description
3405H	The connection number specified by (s1) is other than 1 to 8.
2820H	The device number specified by (s2) or (d) is outside the range of the number of device points.
2822H	Device that cannot be specified is specified.
3582H	When an instruction which cannot be used in interruption routine program is used.

Program example

■Opening a connection using parameter settings

When M1000 is turned on, connection No.1 is opened using the parameters set in "External Device Configuration" of module parameter.

- Devices used

Device No.	Application
SD10680	Open completion signal
SD10681	Open request signal
D100	SP.SOCOPEN instruction control data
M100	SP.SOCOPEN instruction completion device

- Program

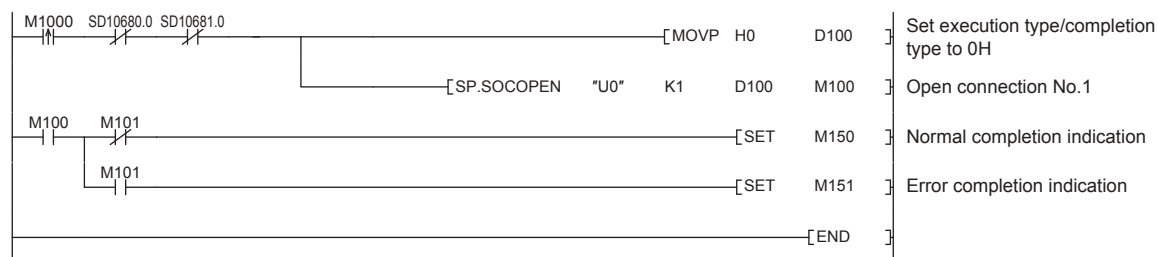

■Opening a connection using control data settings

When M1000 is turned on, connection No.1 is opened using control data.

- Devices used

Device No.	Application
SD10680	Open completion signal
SD10681	Open request signal
D100	SP.SOCOPEN instruction control data
M100	SP.SOCOPEN instruction completion device

- Program

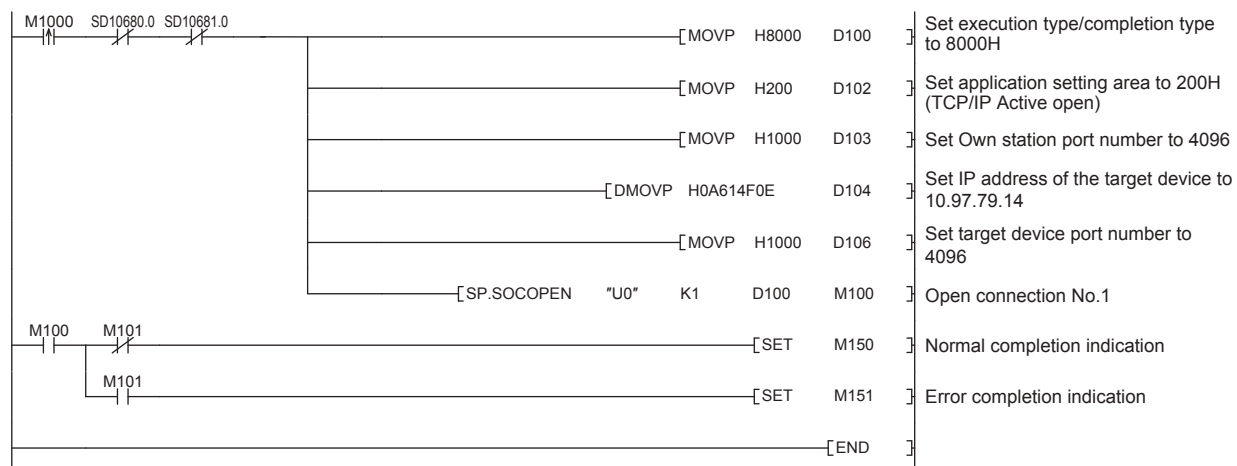

Disconnecting a connection

SP.SOCCLOSE

Closes a connection.

Ladder diagram	Structured text
	<pre>ENO:=SP_SOCCLOSE(EN,U0,s1,s2,d);</pre>

FBD/LD

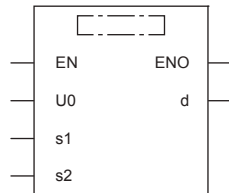

("SP_SOCCLOSE" enters □.)

Setting data

■ Descriptions, ranges, and data types

Operand	Description	Range	Data type	Data type (Label)
(U) ^{*1}	Dummy (Input the character string ['U0'].)	—	Character string	ANYSTRING_SINGLE
(s1)	Connection No.	1 to 8	16-bit unsigned binary	ANY16
(s2)	Start number of the device in which control data is stored	Refer to Control data (Page 81)	Word	ANY16_ARRAY (Number of elements: 2)
(d)	Start number of the device which turns on for one scan upon completion of the instruction. (d)+1 also turns on when failed.	—	Bit	ANYBIT_ARRAY (Number of elements: 2)

*1 In the case of the ST language and the FBD/LD language, U displays as U0.

■ Applicable devices

Operand	Bit	Word			Double word		Indirect specification	Constant			Others
	X, Y, M, L, SM, F, B, SB, S	T, ST, C, D, W, SD, SW, R	U□\G□	Z	LC	LZ		K, H	E	\$	
(U)	—	—	—	—	—	—	—	—	—	○	—
(s1)	—	○	—	—	—	—	○	○	—	—	—
(s2)	—	○	—	—	—	—	○	—	—	—	—
(d)	○	○ ^{*1}	—	—	—	—	—	—	—	—	—

*1 T, ST, C cannot be used.

■ Control data

Device	Item	Description	Setting range	Set by ^{*1}
(s2)+0	System area	—	—	—
(s2)+1	Completion status	Completion status is stored 0000H: Completed Other than 0000H: Failed (Error code) Refer to Page 110 Error Codes	—	System

*1 The "Set by" column indicates the following.

System: The CPU module stores the execution result of the SP.SOCCLOSE instruction.

Processing details

This instruction closes a connection specified in (s1). (Disconnecting a connection)

The result of the SP.SOCCKLOSE instruction can be checked with the completion device, (d)+0 and (d)+1.

- Completion device (d)+0: Turns on in the END processing of a scan after completion of the SP.SOCCKLOSE instruction, and turns off in the next END processing.
- Completion device (d)+1: Turns on or off according to the status at the time of completion of the SP.SOCCKLOSE instruction.

Status	Description
When completed	Remains off.
When failed	Turns on in the END processing of a scan after completion of the SP.SOCCKLOSE instruction, and turns off in the next END processing.

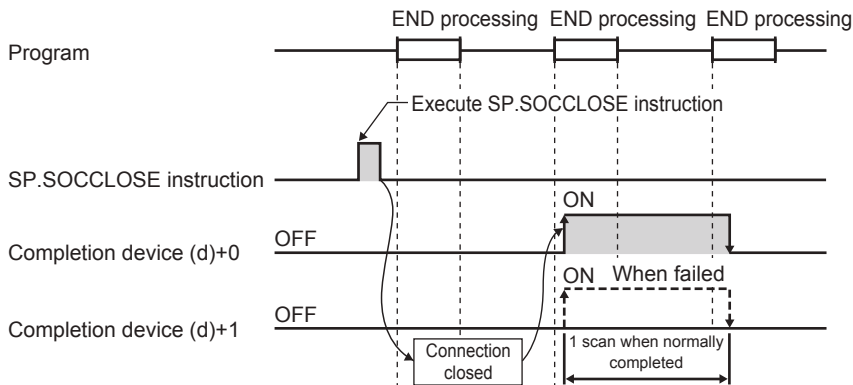

Operation error

Error code (SD0/SD8067)	Description
3405H	The connection number specified by (s1) is other than 1 to 8.
2820H	The device number specified by (s2) or (d) is outside the range of the number of device points.
2822H	Device that cannot be specified is specified.
3582H	When an instruction which cannot be used in interruption routine program is used.

Point

Do not use execute the SP.SOCCKLOSE instruction for Passive open connection. Doing so will turn off the Open completion signal and Open request signal of the connection and cause close processing, which disables data transfer.

Program example

When M2000 is turned on, or when connection No.1 is disconnected from target device, this program disconnects connection No.1.

• Devices used

Device No.	Application
SD10680	Open completion signal
SD10681	Open request signal
D200	SP.SOCCLOSE instruction control data
M200	SP.SOCCLOSE instruction completion device

• Program

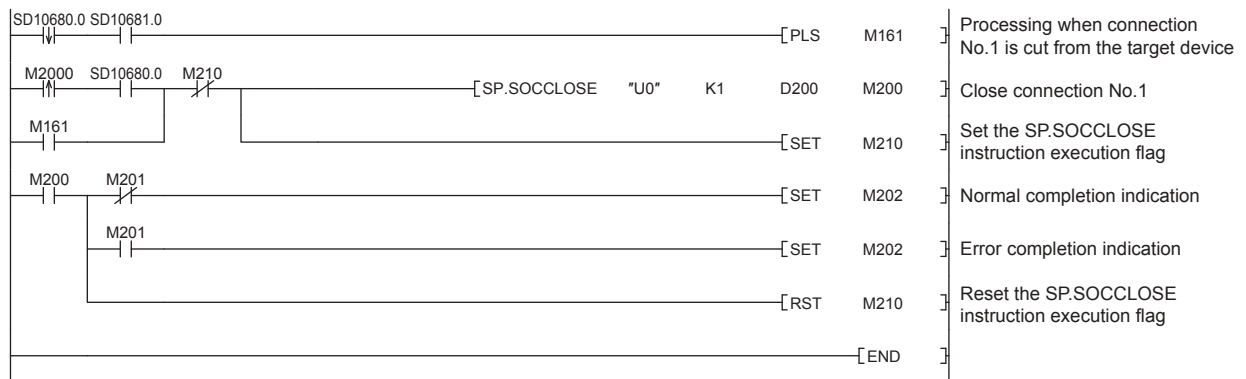

Reading received data in the END processing

SP.SOCRCV

Reads the data received. (Read at END processing)

Ladder diagram	Structured text
	<pre>ENO:=SP_SOCRCV(EN,U0,s1,s2,d1,d2);</pre>

FBD/LD

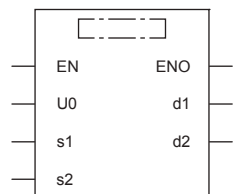

("SP_SOCRCV" enters □.)

Setting data

■Descriptions, ranges, and data types

Operand	Description	Range	Data type	Data type (Label)
(U) ^{*1}	Dummy (Input the character string ['U0'].)	—	Character string	ANYSTRING_SINGLE
(s1)	Connection No.	1 to 8	16-bit unsigned binary	ANY16
(s2)	Start number of the device where control data is specified	Refer to Control data (Page 85)	Word	ANY16_ARRAY (Number of elements: 2)
(d1)	Start number of the device in which received data is stored	—	Word	ANY16
(d2)	Start number of the device which turns on for one scan upon completion of the instruction. (d2)+1 also turns on when failed.	—	Bit	ANYBIT_ARRAY (Number of elements: 2)

*1 In the case of the ST language and the FBD/LD language, U displays as U0.

■Applicable devices

Operand	Bit	Word			Double word		Indirect specification	Constant			Others
	X, Y, M, L, SM, F, B, SB, S	T, ST, C, D, W, SD, SW, R	U□\G□	Z	LC	LZ		K, H	E	\$	
(U)	—	—	—	—	—	—	—	—	—	○	—
(s1)	—	○	—	—	—	—	○	○	—	—	—
(s2)	—	○	—	—	—	—	○	—	—	—	—
(d1)	—	○	—	—	—	—	○	—	—	—	—
(d2)	○	○ ^{*1}	—	—	—	—	—	—	—	—	—

*1 T, ST, C cannot be used.

Control data

Device	Item	Description	Setting range	Set by ^{*1}
(s2)+0	System area	—	—	—
(s2)+1	Completion status	Completion status is stored 0000H: Completed Other than 0000H: Failed (Error code) Refer to  Page 110 Error Codes	—	System
(d1)+0	Received data length	The length of the data which was read from the Socket communication receiving data area is stored. (in bytes)	0 to 2046	System
(d1)+1 to (d1)+n	Received data	The data which was read from the Socket communication receiving data area is stored in order.	—	System

*1 The "Set by" column indicates the following.

System: The CPU module stores the execution result of the SP.SOCRCV instruction.

Point

- When the SP.SOCRCV instruction is executed, data is read from socket communication receiving data area at END processing. Therefore, executing the SP.SOCRCV instruction will increase the scan time.
- When odd-byte data is received, an invalid byte is stored to the higher byte of the device that stores the last received data.

Processing details

This instruction reads received data of the connection specified in (s1) from the socket communication receive data area in the END processing after execution of the SP.SOCRCV instruction.

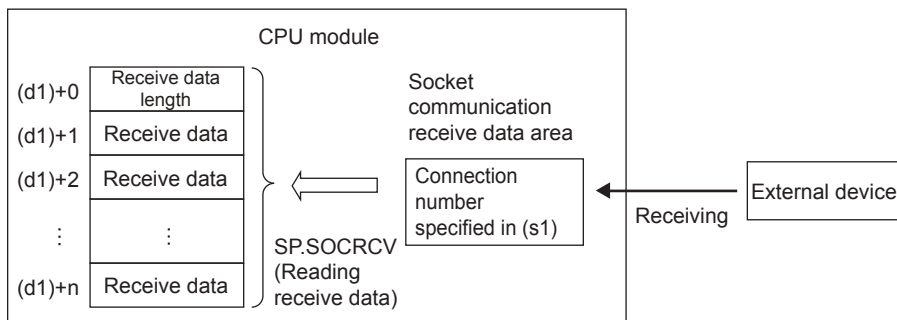

The result of the SP.SOCRCV instruction can be checked with the completion device (d2)+0 and (d2)+1.

- Completion device (d2)+0: Turns on in the END processing of the scan after completion of the SP.SOCRCV instruction, and turns off in the next END processing.
- Completion device (d2)+1: Turns on or off according to the status at the time of completion of the SP.SOCRCV instruction.

Status	Description
When completed	Remains off.
When failed	Turns on in the END processing of the scan after completion of the SP.SOCRCV instruction, and turns off in the next END processing.

The following figure shows the timing of reception processing with the SP.SOCRCV instruction.

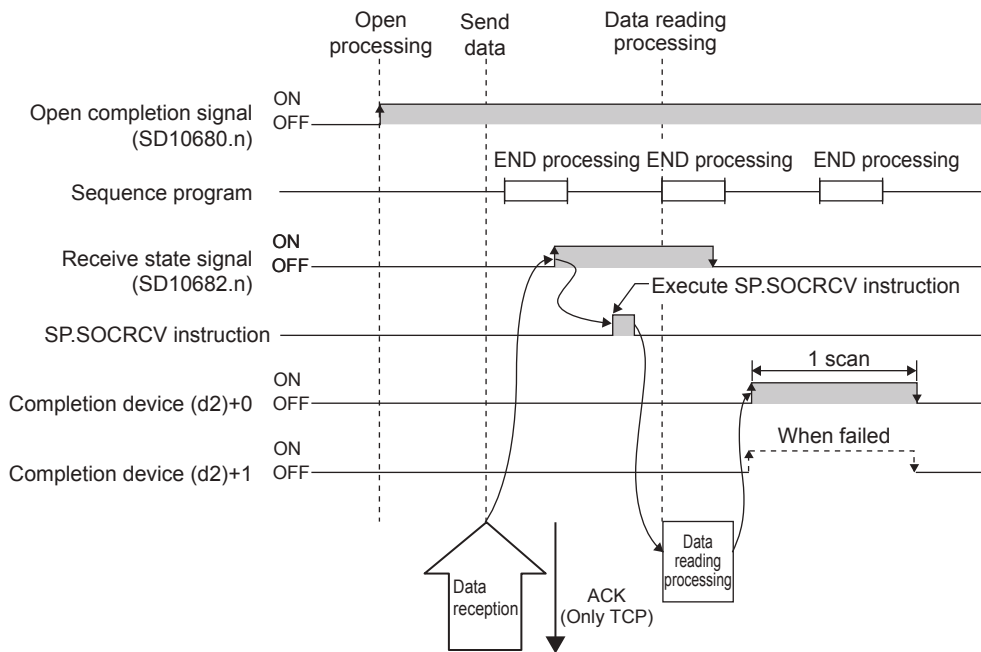

Operation error

Error code (SD0/SD8067)	Description
3405H	The connection number specified by (s1) is other than 1 to 8.
2820H	The size of the receive data exceeds the size of the receive data storage device. The device number specified by (s2), (d1) or (d2) is outside the range of the number of device points.
2822H	Device that cannot be specified is specified.
3582H	When an instruction which cannot be used in interruption routine program is used.

Program example

When M5000 is turned on, data received from the connected device is read.

- Devices used

Device No.	Application
SD10680	Open completion signal
SD10682	Receive state signal
D5000	SP.SOCRCV instruction control data
D500	Received data length and received data storage location
M500	SP.SOCRCV instruction completion device

- Program



Point

Consecutively sent data can be consecutively read by connecting the completion device of the SP.SOCRCV instruction to the execution command as a normally closed contact.

Sending data

SP.SOCSND

Sends data.

Ladder diagram	Structured text
	<pre>ENO:=SP_SOCSND(EN,U0,s1,s2,s3,d);</pre>

FBD/LD

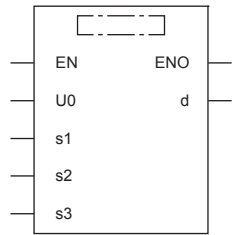

("SP_SOCSND" enters □.)

Setting data

■ Descriptions, ranges, and data types

Operand	Description	Range	Data type	Data type (Label)
(U)*1	Dummy (Input the character string ["U0"].)	—	Character string	ANYSTRING_SINGLE
(s1)	Connection No.	1 to 8	16-bit unsigned binary	ANY16
(s2)	Start number of the device where control data is specified	Refer to Control data (Page 88)	Word	ANY16_ARRAY (Number of elements: 2)
(s3)	Start number of the device in which send data is stored	—	Word	ANY16
(d)	Start number of the device which turns on for one scan upon completion of the instruction. (d)+1 also turns on when failed.	—	Bit	ANYBIT_ARRAY (Number of elements: 2)

*1 In the case of the ST language and the FBD/LD language, U displays as U0.

■ Applicable devices

Operand	Bit	Word			Double word		Indirect specification	Constant			Others
	X, Y, M, L, SM, F, B, SB, S	T, ST, C, D, W, SD, SW, R	U□\G□	Z	LC	LZ		K, H	E	\$	
(U)	—	—	—	—	—	—	—	—	—	○	—
(s1)	—	○	—	—	—	—	○	○	—	—	—
(s2)	—	○	—	—	—	—	○	—	—	—	—
(s3)	—	○	—	—	—	—	○	—	—	—	—
(d)	○	○*1	—	—	—	—	—	—	—	—	—

*1 T, ST, C cannot be used.

Control data

Device	Item	Description	Setting range	Set by ^{*1}
(s2)+0	System area	—	—	—
(s2)+1	Completion status	Completion status is stored. 0000H: Completed Other than 0000H: Failed (Error code) Refer to  Page 110 Error Codes	—	System
(s3)+0	Send data length	The length of send data is specified. (in bytes)	1 to 2046	User
(s3)+1 to (s3)+n	Send data	Send data is specified.	—	User

*1 The "Set by" column indicates the following.

User: The data must be set before executing the SP.SOCSND instruction.

System: The CPU module stores the execution result of the SP.SOCSND instruction.

Point

For TCP, set the send data length within the maximum window size of the target device (receive buffer of TCP). Data whose size exceeds the maximum window size cannot be sent.

Processing details

This instruction sends data set in (s3) to the target device of the connection specified by (s1).

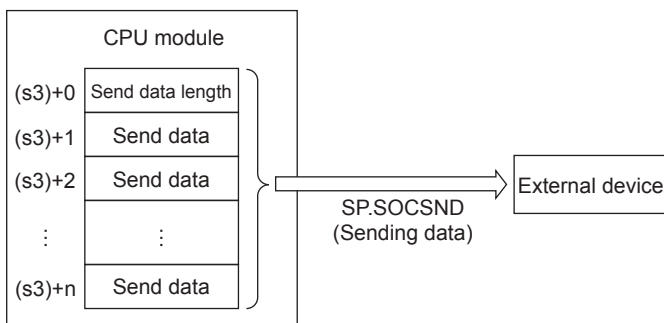

The result of the SP.SOCSND instruction can be checked with the completion device, (d)+0 and (d)+1.

- Completion device (d)+0: Turns on in the END processing of the scan after completion of the SP.SOCSND instruction, and turns off in the next END processing.
- Completion device (d)+1: Turns ON or OFF according to the status at the time of completion of the SP.SOCSND instruction.

Status	Description
When completed	Remains off.
When failed	Turns on in the END processing of the scan after completion of the SP.SOCSND instruction, and turns off in the next END processing.

The following figure shows the timing of send processing with the SP.SOCSND instruction.

<Sending control method>

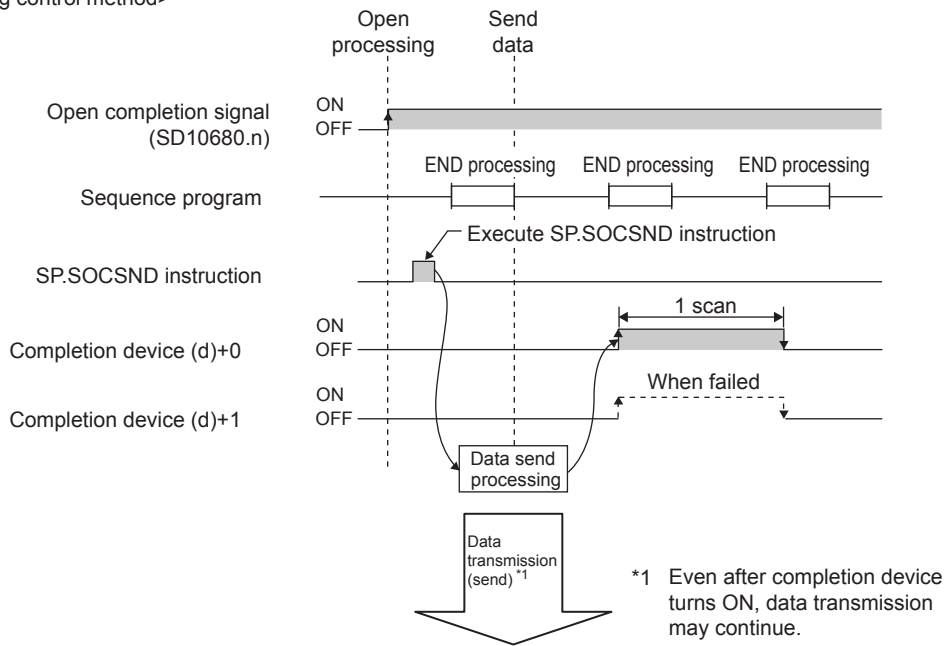

Operation error

Error code (SD0/SD8067)	Description
3405H	The connection number specified by (s1) is other than 1 to 8.
2820H	The device number specified by (s2), (s3) or (d) is outside the range of the number of device points.
2822H	Device that cannot be specified is specified.
3582H	When an instruction which cannot be used in interruption routine program is used.

Program example

When M3000 is turned on, data (1234, 5678, and 8901) are sent to the target device using the socket communication function.

• Devices used

Device No.	Application
SD10680	Open completion signal
D3000	SP.SOCSND instruction control data
D300	Send data length and send data storage location
M300	SP.SOCSND instruction completion device

• Program

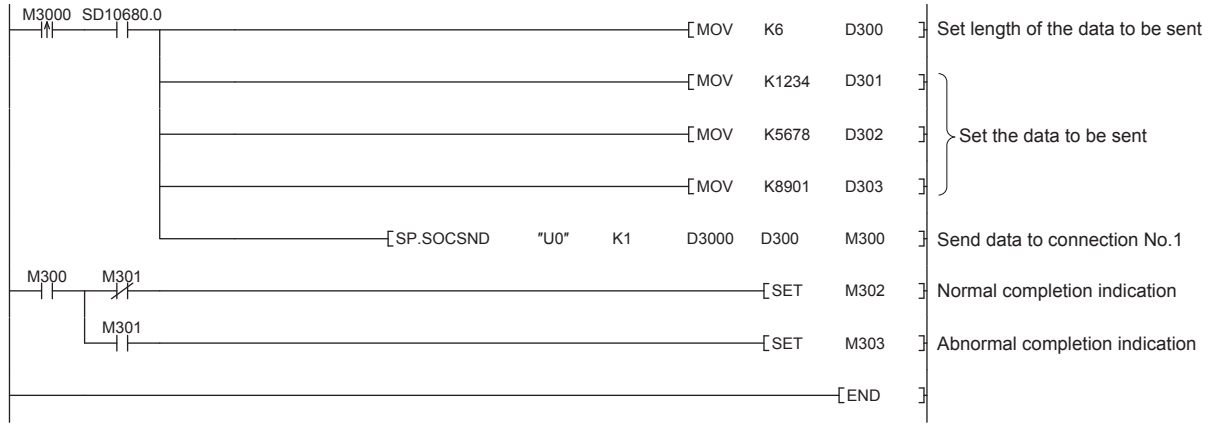

Reading connection information

SP.SOCCINF

Reads connection information.

Ladder diagram	Structured text
	<pre>ENO:=SP_SOCCINF(EN,U0,s1,s2,d);</pre>

FBD/LD

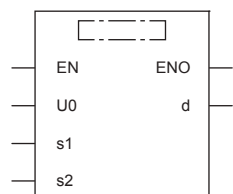

("SP_SOCCINF" enters .)

Setting data

■ Descriptions, ranges, and data types

Operand	Description	Range	Data type	Data type (Label)
(U) ^{*1}	Dummy (Input the character string ['U0'].)	—	Character string	ANYSTRING_SINGLE
(s1)	Connection No.	1 to 8	16-bit unsigned binary	ANY16
(s2)	Start number of the device in which control data is stored	Refer to Control data (Page 91)	Word	ANY16_ARRAY (Number of elements: 2)
(d)	Start number of the device in which connection information is stored	—	Word	ANY16_ARRAY (Number of elements: 5)

*1 In the case of the ST language and the FBD/LD language, U displays as U0.

■ Applicable devices

Operand	Bit	Word			Double word		Indirect specification	Constant			Others
	X, Y, M, L, SM, F, B, SB, S	T, ST, C, D, W, SD, SW, R	U□\G□	Z	LC	LZ		K, H	E	\$	
(U)	—	—	—	—	—	—	—	—	—	○	—
(s1)	—	○	—	—	—	—	○	○	—	—	—
(s2)	—	○	—	—	—	—	○	—	—	—	—
(d)	—	○	—	—	—	—	○	—	—	—	—

Reading socket communication receive data

S(P).SOCRDATA

Reads data from the socket communication receive data area.

Ladder diagram	Structured text
	<pre>ENO:=S_SOCRDATA(EN,U0,s1,s2,n,d); ENO:=SP_SOCRDATA(EN,U0,s1,s2,n,d);</pre>

FBD/LD

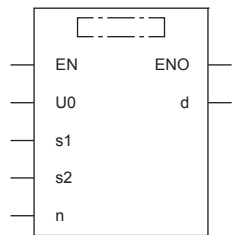

("S_SOCRDATA", "SP_SOCRDATA" enters □.)

Setting data

■Descriptions, ranges, and data types

Operand	Description	Range	Data type	Data type (Label)
(U) ^{*1}	Dummy (Input the character string ["U0"].)	—	Character string	ANYSTRING_SINGLE
(s1)	Connection No.	1 to 8	16-bit unsigned binary	ANY16
(s2)	Start number of the device in which control data is stored	Refer to Control data (☞ Page 92)	Word	ANY16_ARRAY (Number of elements: 2)
(d)	Start number of the device where read data is stored	—	Word	ANY16
(n)	Number of read data (1 to 1024 words)	1 to 1024	16-bit signed binary	ANY16

*1 In the case of the ST language and the FBD/LD language, U displays as U0.

■Applicable devices

Operand	Bit	Word			Double word		Indirect specification	Constant			Others
	X, Y, M, L, SM, F, B, SB, S	T, ST, C, D, W, SD, SW, R	U□\G□	Z	LC	LZ		K, H	E	\$	
(U)	—	—	—	—	—	—	—	—	—	○	—
(s1)	—	○	—	—	—	—	○	○	—	—	—
(s2)	—	○	—	—	—	—	○	—	—	—	—
(d)	—	○	—	—	—	—	○	—	—	—	—
(n)	—	○	—	—	—	—	○	○	—	—	—

■Control data

Device	Item	Description	Setting range	Set by ^{*1}
(s2)+0	System area	—	—	—
(s2)+1	Completion status	Completion status is stored 0000H: Completed Other than 0000H: Failed (Error code) Refer to ☞ Page 110 Error Codes	—	System

*1 The "Set by" column indicates the following.

System: The CPU module stores the execution result of the S(P).SOCRDATA instruction.

Processing details

This instruction reads the data of the amount specified for n from the socket communication receive data area of connection that is specified in (s1), and stores them in the device specified in (d) or higher. No processing is performed when the number of read data (n) is 0.

Point

The received data length can be read by setting the number of read data to one word. This allows change of the device storing receive data, when executing the SP.SOCRCV instruction.

Precautions

- Even if the S(P).SOCRDATA instruction is executed, the next receive data will not be stored in the socket communication receive data area because the area is not cleared and the Receive state signal does not change.
- To update the received data, read the data using the SP.SOCRCV instruction.

Operation error

Error code (SD0/SD8067)	Description
3405H	The connection number specified by (s1) is other than 1 to 8.
2820H	The device number specified by (s2), (d), or (n) is outside the range of the number of device points.
2822H	Device that cannot be specified is specified.

Program example

When M4000 is turned on, the received data length of connection No.1 is read.

- Devices used

Device No.	Application
SD10680	Open completion signal
SD10682	Receive state signal
D400	S.SOCRDATA instruction control data
D4000	Storage location where data is read
K1	Number of read data (one word)

- Program

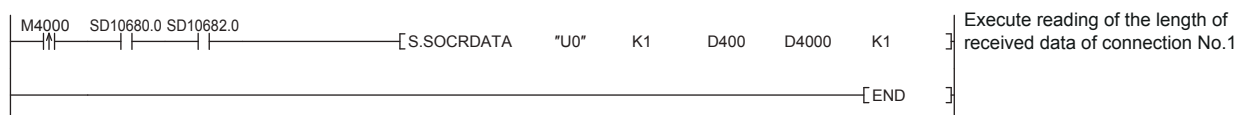

8 REMOTE PASSWORD

Remote password is checked when a connection is requested for the following.

- Communication using an engineering tool
- Communication using SLMP

Point

The remote password function is one of the methods for protection against unauthorized access (e.g. destruction of data and programs) from external devices.

However, this function cannot completely prevent unauthorized access.

Other measures should be taken at users' discretion if security of the programmable controller system against unauthorized access from external devices needs to be maintained. Mitsubishi Electric cannot be held responsible for any problems caused by unauthorized access.

[Examples of measures against unauthorized access]

- Install a firewall.
- Set up a personal computer as a relay station, and control the relay of communication data using an application program.
- Set an external device that can control access rights as a relay station (For external devices that can control access rights, please consult your network service provider or networking equipment vendors.)

8.1 Communication Using Remote Password

Communication is performed in the order described below when a remote password is set for the CPU module.

1. Allowing access (Unlock processing)

On a communication device such as a personal computer, unlock the remote password set for the CPU module.

If it is not unlocked, an error will occur on the connected device because the CPU module will prohibit any access.

2. Access processing

Access the CPU module after successful completion of the remote password unlock processing.

3. Prohibiting access (Lock processing)

When terminating access from the personal computer, lock the remote password to prohibit access from any other personal computers.

[Accessing the Host CPU]

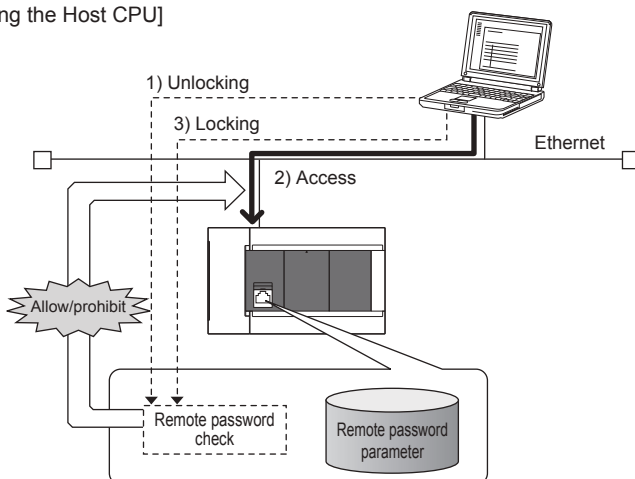

8.2 Remote Password Setting

Setting a remote password

Set a remote password and a target connection in the engineering tool, and write the data to the CPU module.

Navigation Window⇒[Parameter]⇒[Remote Password]⇒[Remote Password Setting] Screen

Item		Description	Setting range
Password		Open "Register Password"/ "Change Password" screen. Enter a remote password to be set for the CPU module.*1	6 to 32 Single byte characters
Product Name	CPU Module	Select "CPU Module" to enable the remote password for the built-in Ethernet port of the CPU module.	Only "CPU Module"
Intelligent Module No.		This setting is not required.	—
Module Conditions	Detail Setting	Click this to display the "Remote Password Detail Setting" screen.	—

*1 Half-width alphanumeric and special characters can be used for remote password entry. (Case-sensitive)

• Remote password detail setting screen

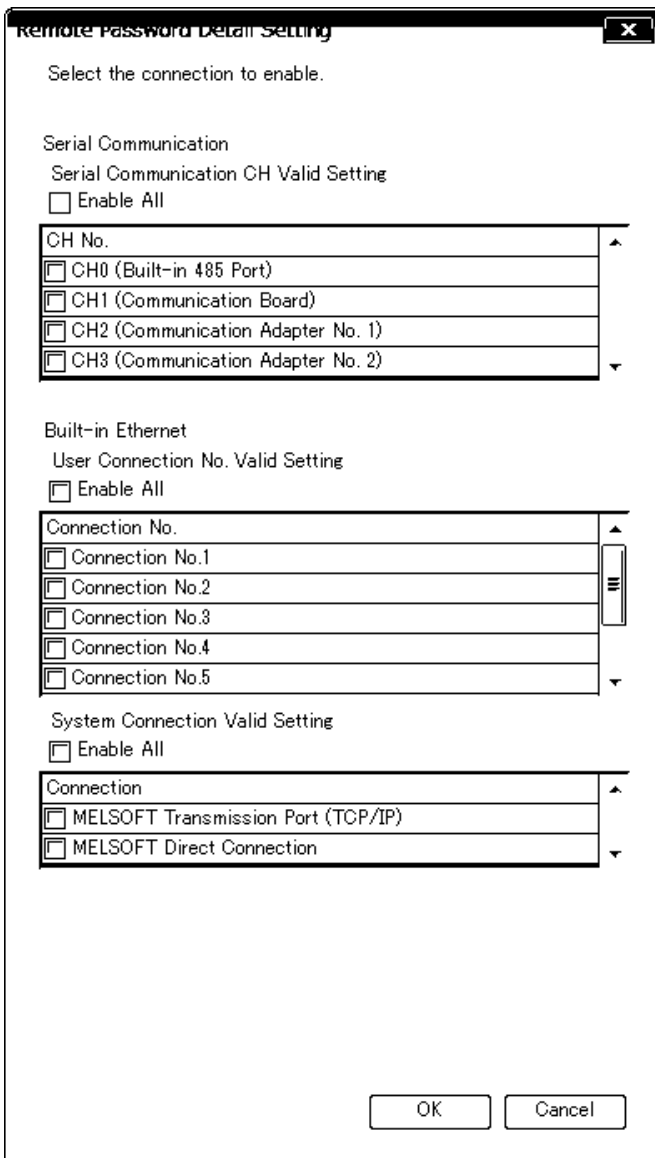

Item		Description	Setting range
Built-in Ethernet	User Connection No. Valid Setting ^{*1}	Connection 1 to 8	Select whether the remote password is to be enabled for the built-in Ethernet port. (Setting of an unused connection or MELSOFT connection is ignored.)
	System Connection Valid Setting ^{*2}	MELSOFT Transmission Port (TCP/IP) ^{*3} MELSOFT Direct Connection ^{*4}	Select whether the remote password is to be enabled for the built-in Ethernet port.

*1 User connection is a connection for users for communication such as SLMP communication.

*2 System connection is used by the system for communication such as MELSOFT communications (TCP/IP).

*3 Check this checkbox to enable the remote password for the ports for which the communication system is set to "MELSOFT Connection" in engineering tool.

*4 Check this checkbox to enable the remote password for CPU module direct connection to engineering tool using the built-in Ethernet port. (Page 16 Direct Connection with Engineering Tool)

Writing to the CPU module

Write the set remote password to the CPU module from the "Write to PLC" screen.

 [Online]⇒[Write to PLC]

After writing the parameters to the CPU module, power off → on or reset the CPU module to enable the parameters.

Unlocking or locking the remote password

The remote password is unlocked or locked from an external device such as a personal computer, as described below.

■When using MELSOFT connection

Enter a remote password in the following screen that appears during communication.

When the remote password is entered, the engineering tool performs unlock processing and then accesses the CPU module

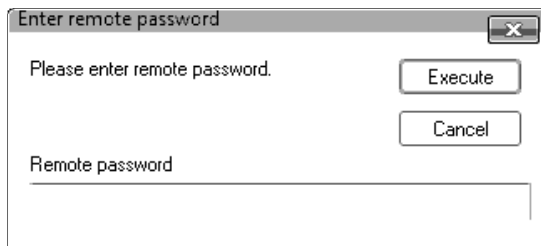

■In case of SLMP

Use commands dedicated to SLMP. (Lock /unlock of  Page 31 Command list)

8.3 Precautions

When a remote password is set for UDP connections

- Determine a target device before data communication. (At the time of SLMP setting, set "Host station port number", "Communication target IP address", "Communication target port number", and limit the communication target.)
- At the end of data communication, always lock the remote password. (If the lock processing is not performed, the unlock state is held until a timeout occurs. No communication for 10 minutes causes a timeout, and the CPU module automatically performs lock processing.)

To prevent unauthorized access using the remote password setting, it is recommended to set all connection protocols to TCP/IP and set the parameter to disable direct connection.

When a TCP/IP connection is closed before lock processing

The CPU module automatically performs lock processing.

Further, when protocol is set to TCP, connection is verified by KeepAlive. (Response to KeepAlive ACK message)

An alive check message is sent 5 seconds after reception of the last message from the device with which communication is being done to check if the device returns a response or not. If no response is received, the alive check message will be resent at intervals of 5 seconds. When no response is received for 45 seconds, the connected device is regarded as non-existent and the connection is disconnected.

Therefore, the lock process is automatically executed when the connection is cut.

Valid range of remote password

The remote password is valid only for accessing the module (communication port) for which the parameter is set.

In case of a system configuration that uses multiple modules, set a remote password for each module (communication ports).

8.4 Detection of Unauthorized Access and Actions

When the password mismatch count reaches a fixed count (upper limit) in the unlock process of remote password, access is locked out. If this occurs, unauthorized access from outside the system can be considered as a cause of the error.

Take the following actions as needed.

1. Monitor the unlock failure count (SD10270 to SD10277) and identify the connection in which the mismatch count has reached a fixed count (upper limit) in unlock processing. The continuous unlock lost counts also can be identified on the "Ethernet Diagnostics" screen of GX Works3.

[Diagnostics] ⇒ [Ethernet Diagnostics] ⇒ "Status of Each Connection"

The screenshot shows the 'Ethernet Diagnostics' window with the 'Status of Each Connection' tab selected. The table below represents the data shown in the interface:

Connection No. /Function	Host Station Port No.	Communication Destination Communication Method	Communication Destination IP Address	Communication Destination Port No.	Latest Error Code	Protocol	Open System	TCP Status	Remote Password Status	Continuous Unlock Lost Counts
1	1000	SLMP	----	----	----	UDP	----	----	Invalid Or Cancel	0
2	----	MELSOFT Connection	----	----	----	TCP	----	Disconnected	Invalid Or Cancel	0
3	1770	Socket Communication	*** ** *	8000	----	UDP	----	----	Invalid Or Cancel	----
4	1771	Socket Communication	----	----	----	TCP	Active	Disconnected	Invalid Or Cancel	----
5	1772	Socket Communication	----	----	----	TCP	Unpassive	Disconnected	Invalid Or Cancel	----
6	1773	Socket Communication	----	----	----	TCP	Fullpassive	Disconnected	Invalid Or Cancel	----
7	----	----	----	----	----	----	----	----	----	----
8	----	----	----	----	----	----	----	----	----	----
MELSOFT Direct	----	----	*** ** *	61503	4171	----	----	----	Invalid Or Cancel	1

2. Inform your system administrator that the number of unlock processing failures exceeded the limit, and take appropriate actions.

9 IP ADDRESS CHANGE FUNCTION

9.1 Overview of the IP address change function

This function is provided to change the IP address of the CPU module (built-in Ethernet port) by setting the desired IP address to special registers from a peripheral unit or another unit and turning ON a special relay.

This function changes the IP address of the CPU module even if no settings are made in GX Works3 PLC parameters.

When the IP address change function is used, the IP address stored in the IP address storage area (CPU module internal FRAM), not the IP address setting of the module parameter Ethernet port in GX Works3, is set to the CPU module.

This function can set three types of data - IP address, subnet mask pattern and default gateway IP address.

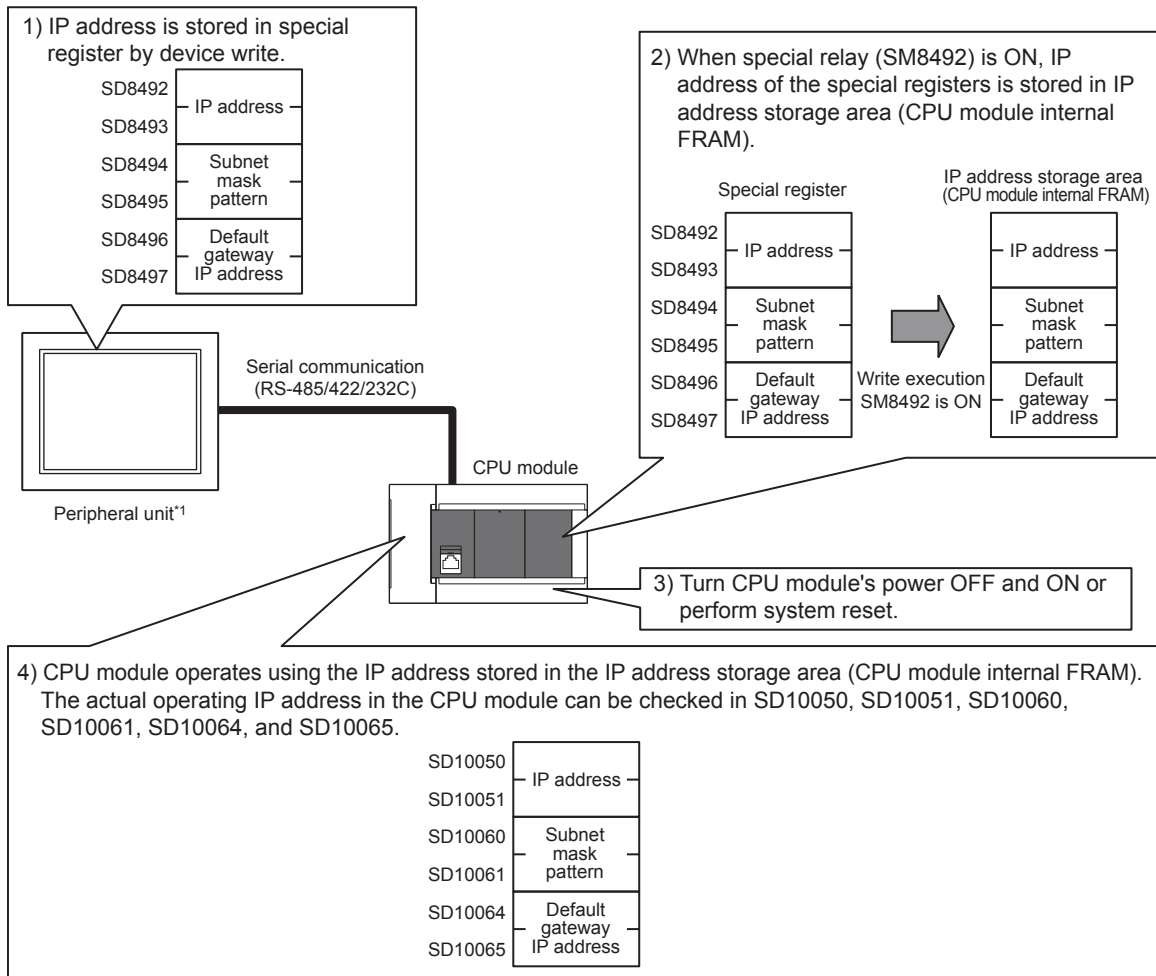

*1 The IP address change function can be used not only by peripheral units but also by link function, MX Component and MX Sheet by manipulating values of the special devices. For details on link function, refer to the MELSEC iQ-F FX5 User's Manual(Serial Communication). For details on MX Component and MX Sheet, refer to the respective product manual.

Point

- For details on special relays and special register to use IP address change function, refer to Page 116 List of Special Device Applications and Assignments.
- The IP address storage area is different from the storage of the module parameter Ethernet port setting.
- The IP address storage area is provided in the CPU module (CPU module internal FRAM). The IP address is not stored in the SD memory card even if a SD memory card is attached. The setting stored in the IP address storage area is not changed even if the SD memory card is replaced.

9.2 IP address to be set for the CPU module

When the IP address change function is used, the IP address stored in the IP address storage area (CPU module internal FRAM), not the IP address setting of the module parameter Ethernet port in GX Works3, is set to the CPU module.

When the power of the CPU module is turned OFF and ON or system reset is performed, the IP address and other data stored in the IP address storage area are reflected on the CPU module, and the IP address change function enable flag (SM8498) turns ON.

[In the case IP address change function is used]

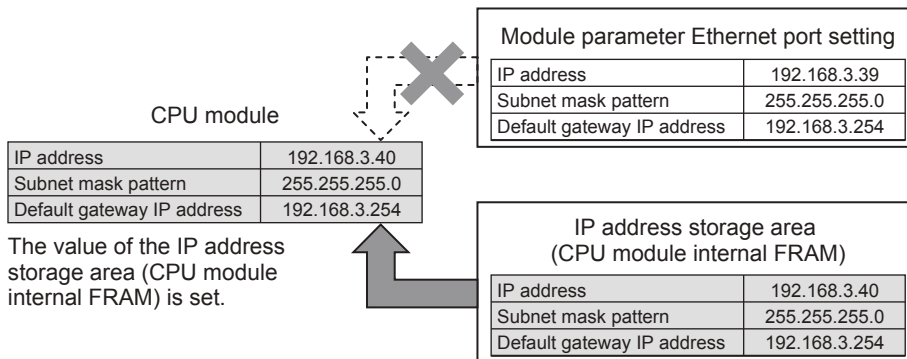

[In the case Module parameter Ethernet port setting is used (IP address storage area is cleared)]

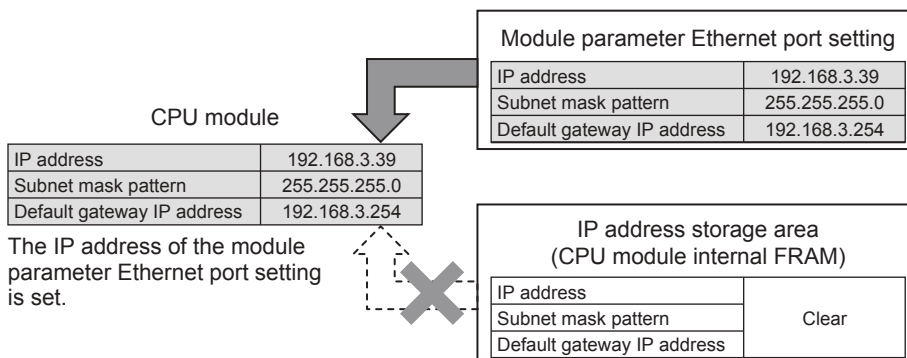

When IP address storage area is cleared (IP address change function enable flag SM8498 is OFF), module parameter Ethernet port setting is enabled.

9.3 Write operation to IP address storage area

Set the IP address and other data to be set to special registers (SD8492 to SD8497), and turn the special relay (SM8492) from OFF to ON to write the data to the IP address storage area (CPU module internal FRAM).

Set the IP address, etc. to the special registers (SD8492 to SD8497) as hexadecimal values.

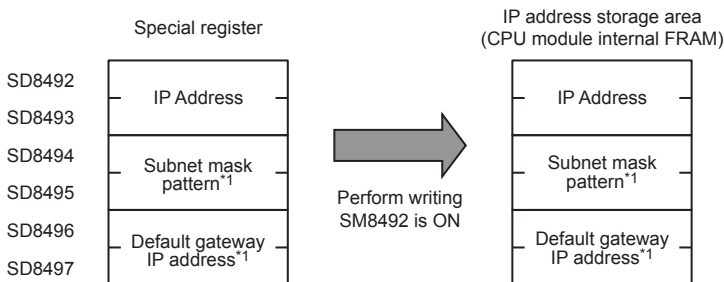

*1 It is possible to specify no setting (0.0.0.0) for the subnet mask pattern and default gateway IP address. However, it is necessary to specify no setting (0.0.0.0) for both the subnet mask pattern and the default gateway IP address. If no setting (0.0.0.0) is specified for only one, an error will occur and the IP address will not be changed.

It is possible to write data to the IP address storage area without regard to the CPU module mode (RUN or STOP). To reflect the setting stored in the IP address storage area on the CPU module, it is necessary to turn OFF and ON the power or perform system reset of the CPU module.

IP address storage area write procedure

The figure below shows the procedure to write data to the IP address storage area and change the IP address of the CPU module.

Write operation

■Operations

1. Store the value to be changed in SD8492 to SD8497 (IP address setting or other).
2. Turn off and on SM8492 (IP address storage area write request).
3. Check the write results with the following special relays and special registers.

Device No.	Name	At normal completion	At abnormal completion
SM8492	IP address storage area write request	Off	Off
SM8493	IP address storage area write completed	On	On
SM8494	IP address storage area write error	Off	On
SD8498	IP address storage area write error code	—	Stores the error code

4. When the write is completed normally, power off and on or reset the CPU module.
5. If the IP address stored in the IP address storage area (CPU module internal FRAM) is a valid value, the stored IP address is set as the CPU module's IP address.
6. The IP address or other setting of the CPU module can be checked with the following special register.

Device No.	Name	Description
SD10050, SD10051	IP address	The IP address currently set in the CPU module is stored.
SD10060, SD10061	Subnet mask	The subnet mask currently set in the CPU module is stored.
SD10064, SD10065	Default gateway IP address	The default gateway IP address currently set in the CPU module is stored.

■Error code at error occurrence

If the data is not written correctly into the IP address storage area (CPU module internal FRAM), the error code is stored in IP address storage area write error code (SD8498).

Value of SD8498	Error details and causes	Action
1920H	IP address setting or other (SD8492 to SD8497) value exceeds the setting range.	Correct the IP address setting or other (SD8492 to SD8497) value.

9.4 Clear operation to IP address storage area

When the special relay (SM8495) turns from OFF to ON, IP address storage area (CPU module internal FRAM) can be cleared. (IP address change function can be disabled.)

IP address storage area clear procedure

IP address storage area clear procedure is described.

Clearing operation

■Operations

1. Turn off and on SM8495 (IP address storage area clear request).
2. Check the clear results with the following special relays and special registers.

Device No.	Name	At normal completion	At abnormal completion
SM8495	IP address storage area clear request	Off	Off
SM8496	IP address storage area clear completed	On	On
SM8497	IP address storage area clear error	Off	On
SD8499	IP address storage area clear error code	—	Stores the error code

3. When it completed normally, power off and on or reset the CPU module.
4. The IP address or other setting of the CPU module can be checked with the following special register.

Device No.	Name	Description
SD10050, SD10051	IP address	The IP address currently set in the CPU module is stored.
SD10060, SD10061	Subnet mask	The subnet mask currently set in the CPU module is stored.
SD10064, SD10065	Default gateway IP address	The default gateway IP address currently set in the CPU module is stored.

■Error code at error occurrence

If the data is not clear correctly into the IP address storage area (CPU module internal FRAM), the error code is stored in IP address storage area clear error code (SD8499).

Value of SD8499	Error details and causes	Action
1921H	Write request and clear request (SM8492 and SM8495) turned from OFF to ON simultaneously.	Check if write request and clear request (SM8492 and SM8495) turned from OFF to ON simultaneously.

9.5 Precautions

The following section lists the precautions for using the IP address.

Power off and reset operation

Do not turn the CPU module power off or execute reset when writing to or clearing the IP address storage area (CPU module internal FRAM). The values may not be applied to the IP address storage area (CPU module internal FRAM). Power off or reset the CPU module after checking the falling edge of SM8492 (IP address storage area write request) or SM8495 (IP address storage area clear request).

Parameter IP address

For the CPU module IP address, the value in the IP address storage area (CPU module internal FRAM) has precedence over the module parameter Ethernet port value. Whether the IP address change function is enabled can be checked by the IP address change function enable flag (SM8498). When using the IP address specified with the module parameter Ethernet port, clear the IP address storage area (CPU module internal FRAM).

Write processing and clear processing execution timing

- It may not be possible to execute the write or clear processing to the IP address storage area (CPU module internal FRAM) if an operation that turns off and on, or on and off SM8492 (IP address storage area write request) or SM8495 (IP address storage area clear request) in a short time is executed.
- If SM8492 (IP address storage area write request) is turned off and on again while writing to the IP address storage area (CPU module internal FRAM), the write processing that was executed first will complete normally, and the following write operation will be ignored. (This also applies to the clear operation.)
- If SM8495 (IP address storage area clear request) is turned off and on again while writing to the IP address storage area (CPU module internal FRAM), the clear operation will not be completed. (This also applies if writing is executed during the clear processing.)
- If both SM8492 (IP address storage area write request) and SM8495 (IP address storage area clear request) are turned off and on, the write operation will take priority, and the clear operation will not be completed.

10 TROUBLESHOOTING

This section contains an explanation of errors that may occur during communication between built-in Ethernet and other devices, and troubleshooting for such errors.

The methods for checking the built-in Ethernet for errors and the contents of errors are as follows.

In either case, after checking for errors and the contents of the errors, take proper measures to eliminate the error.

Check by display LEDs on the front of the CPU module

You can check whether or not errors currently exist on the CPU module (built-in Ethernet) by the status of the display LEDs.

Check using GX Works3

You can check error code corresponding to errors currently occurring, status of the built-in Ethernet side, and conduct tests using GX Works3.

■ Ethernet diagnostics (Page 105 Ethernet diagnostics)

- Checking error contents by error code ( Page 110 Error codes of the Ethernet communication)

Point

If a line error, etc., occurs when connecting with devices of multiple manufacturers, determine the location of the error by using a line analyzer, etc.

10.1 Checking Errors by LEDs

This section contains an explanation of errors that can be checked by LEDs on the front of the CPU module.

Error display check

The following can be checked by LEDs on the front of the CPU module.

<CPU module LED>

LED name	Check condition	Cause/action
PWR	Does not turn on when power of CPU module is turned on	Power source may not be correctly connected to the CPU module. Check the connection status. If there is nothing wrong with connection, the hardware may be faulty. For repair, contact your local Mitsubishi Electric representative.
ERR	Turns on when power of CPU module is turned on	In case of built-in Ethernet parameter setting error: <ul style="list-style-type: none"> • Check/correct built-in Ethernet parameter setting values using GX Works3. In case of CPU module error (hardware error): <ul style="list-style-type: none"> • For repair, contact your local Mitsubishi Electric representative.
	Flashes when power of CPU module is turned on Or flashes temporarily	Check the contents of the error by error code stored when error is detected by the following processing, and eliminate the cause of the error. <ul style="list-style-type: none"> • Initial process • Open process • SLMP communication process • Other processing (processing wherein error code is stored) For error codes, refer to  Page 110 Error codes of the Ethernet communication.
SD/RD	Does not turn on when data is sent/received	If [ERR] is lit: <ul style="list-style-type: none"> • Eliminate the cause of [ERR] being lit. If cable connection is faulty: <ul style="list-style-type: none"> • Check cable connection. • Perform initial processing completion check and check if there is anything wrong with the Ethernet line. In case of own station IP address setting error: <ul style="list-style-type: none"> • If there is nothing wrong with cable connection, check the setting values of own station IP address, router setting and subnet mask setting by GX Works3. If there is something wrong with transmission program of other device: <ul style="list-style-type: none"> • Check the transmission program of other device.

Error information read/clear method

You can read and clear error information by Ethernet diagnostics of GX Works3.

For details concerning Ethernet diagnostics of GX Works3, refer to  Page 105 Checking Errors by GX Works3.

10.2 Checking Errors by GX Works3

10

You can check built-in Ethernet status, parameter settings, communication status, etc., with the Ethernet diagnostics function of GX Works3.

Ethernet diagnostics

For details concerning Ethernet diagnostics of GX Works3, refer to  GX Works3 Operating Manual.

- Ethernet diagnostics screen

 [Diagnostics] ⇒ [Ethernet Diagnostics]

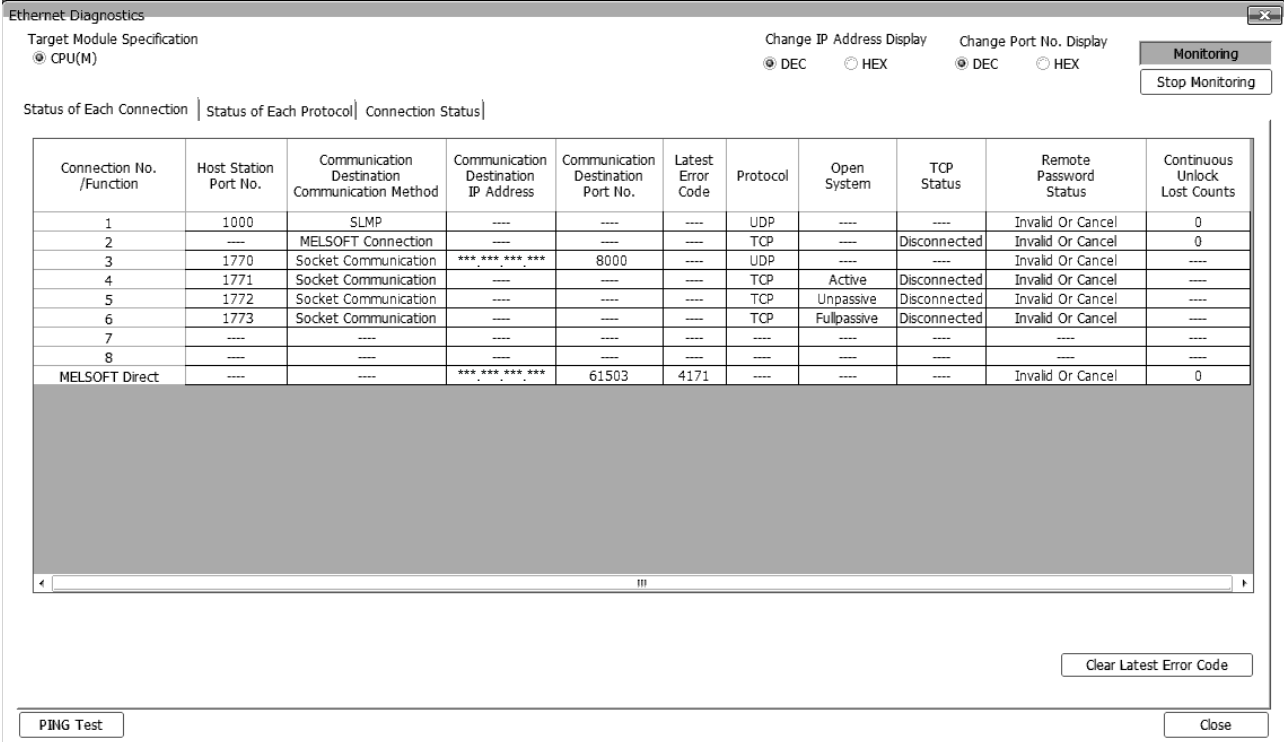

Connection No. /Function	Host Station Port No.	Communication Destination Communication Method	Communication Destination IP Address	Communication Destination Port No.	Latest Error Code	Protocol	Open System	TCP Status	Remote Password Status	Continuous Unlock Lost Counts
1	1000	SLMP	----	----	----	UDP	----	----	Invalid Or Cancel	0
2	----	MELSOFT Connection	----	----	----	TCP	----	Disconnected	Invalid Or Cancel	0
3	1770	Socket Communication	*** ** *	8000	----	UDP	----	----	Invalid Or Cancel	----
4	1771	Socket Communication	----	----	----	TCP	Active	Disconnected	Invalid Or Cancel	----
5	1772	Socket Communication	----	----	----	TCP	Unpassive	Disconnected	Invalid Or Cancel	----
6	1773	Socket Communication	----	----	----	TCP	Fullpassive	Disconnected	Invalid Or Cancel	----
7	----	----	----	----	----	----	----	----	----	----
8	----	----	----	----	----	----	----	----	----	----
MELSOFT Direct	----	----	*** ** *	61503	4171	----	----	----	Invalid Or Cancel	0

- Ethernet diagnostics item

Item	Description
Status of Each Connection	Displays information concerning status of each connection.
Status of Each Protocol	The total of the send/receive of the packet etc. for each protocol is displayed.
Connection Status	Monitors connection status.

Status of Each Connection

The status of each connection of the CPU module selected.

Ethernet Diagnostics

Target Module Specification
 CPU(M)

Change IP Address Display: DEC HEX
 Change Port No. Display: DEC HEX

Monitoring
 Stop Monitoring

Status of Each Connection | Status of Each Protocol | Connection Status

Connection No./Function	Host Station Port No.	Communication Destination Communication Method	Communication Destination IP Address	Communication Destination Port No.	Latest Error Code	Protocol	Open System	TCP Status	Remote Password Status	Continuous Unlock Lost Counts
1	1000	SLMP	----	----	----	UDP	----	----	Invalid Or Cancel	0
2	----	MELSOFT Connection	----	----	----	TCP	----	Disconnected	Invalid Or Cancel	0
3	1770	Socket Communication	***.***.***.***	8000	----	UDP	----	----	Invalid Or Cancel	----
4	1771	Socket Communication	----	----	----	TCP	Active	Disconnected	Invalid Or Cancel	----
5	1772	Socket Communication	----	----	----	TCP	Unpassive	Disconnected	Invalid Or Cancel	----
6	1773	Socket Communication	----	----	----	TCP	Fullpassive	Disconnected	Invalid Or Cancel	----
7	----	----	----	----	----	----	----	----	----	----
8	----	----	----	----	----	----	----	----	----	----
MELSOFT Direct	----	----	***.***.***.***	61503	4171	----	----	----	Invalid Or Cancel	0

Clear Latest Error Code

Close

PING Test

The following table lists the displayed items in "Status of Each Connection" tab.

Item	Description
Connection No./Function	Displays the connection number and functions (MELSOFT direct connection).
Host Station Port No.	Displays the own station port number used.
Communication Destination Communication Method	Displays the communication method.
Communication Destination IP Address	Displays the IP address of the sensor/device to be connected, which is set in the parameter settings.
Communication Destination Port No.	Displays the port number of the sensor/device to be connected, which is set in the parameter settings.
Latest Error Code	Displays the error code that indicates the definition of latest error occurred.
Protocol	Displays the protocol (TCP/IP or UDP/IP)
Open System	Displays the open method (Active, Unpassive, or Fullpassive) when the protocol of the connection is TCP/IP.
TCP Status	Displays the status (open status) of connection with the sensor/device when the protocol of the connection status is TCP/IP.
Remote Password Status	Displays the remote password setting status.
Continuous Unlock Lost Counts	Displays the total number of continuous failure of remote password unlock.

Click the [Clear Latest Error Code] button to clear all the errors displayed in "Latest Error Code" of each connection.

Status of Each Protocol

The total number of packets sent/received by each protocol of the selected CPU module can be checked.

The screenshot shows the 'Ethernet Diagnostics' window with the 'Status of Each Protocol' tab selected. The window title is 'Ethernet Diagnostics'. Under 'Target Module Specification', 'CPU(M)' is selected. There are options for 'Change IP Address Display' (DEC, HEX) and 'Change Port No. Display' (DEC, HEX). A 'Monitoring' section has 'Monitoring' and 'Stop Monitoring' buttons. The main area shows a table of statistics:

	IP Packet	ICMP Packet	TCP Packet	UDP Packet
Total Number of Receives	1470	0	0	1464
Total Number of Sends	1463	0	0	1463
Total Number of Sum Check Error Cancels	-	-	-	-
Total Number of Echo Request Receives		0		
Total Number of Echo Reply Sends		0		
Total Number of Echo Request Sends		0		
Total Number of Echo Reply Receives		0		

At the bottom left is a 'PING Test' button and at the bottom right is a 'Close' button.

The following table lists the displayed items in "Status of Each Protocol" tab.

Item	Description	Display range
Total Number of Receives	Displays the total number of received packets.	0 to 4294967295
Total Number of Sends	Displays the total number of sent packets.	0 to 4294967295
Total Number of Sum Check Error Cancels	Not supported.	—
Total Number of Echo Request Receives	Displays the total number of received ICMP echo request packets.	0 to 4294967295
Total Number of Echo Reply Sends	Displays the total number of sent ICMP echo reply packets.	0 to 4294967295
Total Number of Echo Request Sends	Displays the total number of sent ICMP echo request packets.	0 to 4294967295
Total Number of Echo Reply Receives	Displays the total number of received ICMP echo reply packets.	0 to 4294967295

Connection Status

The communication status of the CPU module.

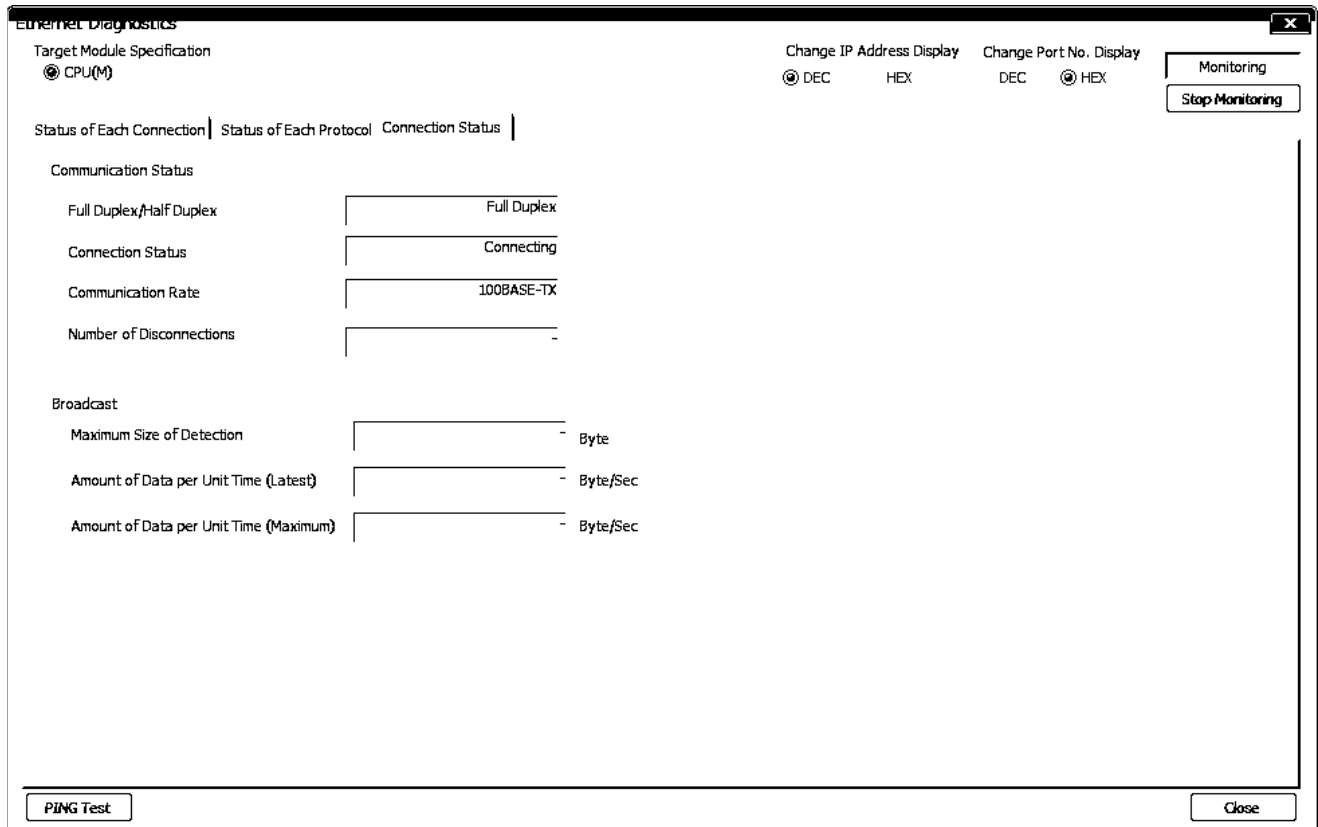

The following table lists the displayed items in "Connection Status" tab.

Item		Description	Display range
Communication Status	Full Duplex/Half Duplex	Displays whether the line is full-duplex or half-duplex.	—
	Connection Status	Displays the cable connection status.	—
	Communication Rate	Displays the communication speed.	—
	Number of Disconnections	Not supported.	—
Broadcast	Maximum Size of Detection	Not supported.	—
	Amount of Data per Unit Time (Latest)	Not supported.	—
	Amount of Data per Unit Time (Maximum)	Not supported.	—

PING Test

The PING test checks existence of an Ethernet device on the same Ethernet network.

This test is performed on the network of stations connected to the GX Works3 by sending packets for check. If a response returns, the communication can be performed.

🖱️ "Ethernet Diagnostics" window ⇨ [PING Test] button

The screenshot shows the "PING Test" dialog box. It includes fields for "Address Specification" (IP Address selected), "IP Address Input Form" (DEC selected), "Setting Options" (Display the Host Name unchecked), "Specify the Data Size" (32 Byte), "Specify the Communication Time Check" (1 Seconds), and "Specify the Number of Sends" (4 Times). There are "Execute" and "Cancel" buttons. A "Result" section is present at the bottom, along with a "Close" button and a status line "Number of Successes/Transmissions = /".

■Procedure

Set the required items in "Input Item" and click the [Execute] button to execute the PING test. The test results are displayed in the "Result" box.

■Action for abnormal end

If the test fails, check the following and perform the test again.

- Connection to the Ethernet network
- Parameter settings written in the CPU module
- Operating status of the CPU module (whether or not an error has occurred)
- IP addresses set in GX Works3 and the PING test target station
- Whether the external device has been reset after the CPU module was replaced

10.3 Error Codes

For the error codes (stored in SD0/SD8067) common among CPU modules, refer to the  MELSEC iQ-F FX5 User's Manual(Application).

Error codes of the IP address change function

The description and corrective action for error codes generated by the IP address change function are explained.

Error codes are stored in SD8498 (IP address storage area write error code) or SD8499 (IP address storage area clear error code).

Error code (Hexadecimal)	Error details and causes	Action
1920H	IP address setting or other (SD8492 to SD8497) value exceeds the setting range.	Correct the IP address setting or other (SD8492 to SD8497) value.
1921H	Write request and clear request (SM8492 and SM8495) turned from OFF to ON simultaneously.	Check if write request and clear request (SM8492 and SM8495) turned from OFF to ON simultaneously.

Error codes of the Ethernet communication

This section contains an explanation of the contents and method of handling of error codes for errors that occur during various processing for data communication between CPU module (built-in Ethernet) and other devices, and processing requests from own station (built-in Ethernet).

Error codes are stored in built-in Ethernet error code SD10130 (connection 1) to SD10137 (connection 8). However, in case of multiple errors, the error code of the last error that occurred is stored in SD10130 (connection 1) to SD10137 (connection 8).

Error code (Hexadecimal)	Error details and causes	Action
112EH	Connection could not be established in open processing.	<ul style="list-style-type: none"> • Check the operation of the external device. • Check if open processing has been performed in the external device. • Correct the port number of the Ethernet-equipped module, IP address/port number of the external device, and opening method. • When a firewall is set in the external device, check if access is permitted. • Check if the Ethernet cable is disconnected.
1134H	A TCP ULP timeout error has occurred in the TCP/IP communication. (The external device does not send an ACK response.)	<ul style="list-style-type: none"> • Check the operation of the external device. • Correct the TCP ULP timeout value of the Ethernet-equipped module. • Since there may be congestion of packets on the line, send data after a certain period of time. • Check if the connection cable is disconnected.
2160H	Overlapping IP addresses were detected.	Check and correct the IP addresses.
2250H (Stores in SD0)	The protocol setting data stored in the CPU module is not for available modules.	Write the protocol setting data for available modules to the CPU module.
C012H	Open processing with the external device failed. (For TCP/IP)	Correct the port numbers of the CPU module and the external device.
C013H	Open processing with the external device failed. (For UDP/IP)	Correct the port numbers of the CPU module and the external device.
C018H	The IP address specified value of the external device is incorrect.	Correct the IP address specified value of the external device.
C020H	The send/receive data length exceeds the allowable range.	<ul style="list-style-type: none"> • Correct the data length to be sent. • When the amount of data to be sent exceeds the limit, divide the data into smaller chunks to send it.
C027H	Socket communication send message has failed.	<ul style="list-style-type: none"> • Check the operation of the external device or switching hub. • Since there may be congestion of packets on the line, send data after a certain period of time. • Check if the connection cable is disconnected. • Check that there is no connection failure with the switching hub. • Execute the communication status test, and if the test was completed with an error, take the corrective action. • Execute the module communication test, and check that there is no failure in the module.
C029H	<ul style="list-style-type: none"> • Description of control data is not correct. • Open instruction was executed through open settings parameter even though parameters are not set. 	<ul style="list-style-type: none"> • Correct the descriptions of the control data. • Set the open settings parameters. Or, execute the OPEN instruction through control data.

Error code (Hexadecimal)	Error details and causes	Action
C0DEH	Socket communication receive message has failed.	<ul style="list-style-type: none"> • Check the operation of the external device or switching hub. • Since there may be congestion of packets on the line, send data after a certain period of time. • Check if the connection cable is disconnected. • Check that there is no connection failure with the switching hub. • Execute the communication status test, and if the test was completed with an error, take the corrective action. • Execute the module communication test, and check that there is no failure in the module.
C1AFH	The specified port number is incorrect.	Correct the specified port number.
C1B0H	The open processing of the specified connection has been already completed.	<ul style="list-style-type: none"> • Do not perform the open processing to an already opened connection. • When communications with the external device cannot be performed, perform the close processing before the open processing.
C1B1H	The open processing of the specified connection has not been completed.	After completion of the open processing, perform the communication.
C1D3H	A dedicated instruction not supported by the communication method of the connection was executed.	<ul style="list-style-type: none"> • Check that the dedicated instruction can be executed by the specified communication method. Correct the program if the instruction cannot be executed. • Check that there is no error in the connection specification of the dedicated instruction.
C400H	The SP.ECPRTCL instruction was executed when "Predefined protocol ready (SD10692)" was "0".	<ul style="list-style-type: none"> • Execute the SP.ECPRTCL instruction after "Predefined protocol ready (SD10692)" has become "1". • Execute the SP.ECPRTCL instruction after rewriting the protocol setting data to the CPU module. • If the error occurs again even after rewriting, replace the CPU module.
C401H	<ul style="list-style-type: none"> • The control data of the SP.ECPRTCL instruction specified a protocol number not registered in the CPU module. • The SP.ECPRTCL instruction was executed while the protocol setting data was not written. 	<ul style="list-style-type: none"> • Check whether the specified protocol number is correct. • Check the presence/absence of protocol registration (SD10722 to SD10725), and then check whether the specified protocol number is registered. • Write the protocol setting data, and then execute the SP.ECPRTCL instruction.
C404H	The cancel request was received while the protocol was executed, and the SP.ECPRTCL instruction was finished abnormally.	Check the canceled protocol in the control data of the SP.ECPRTCL instruction (execution count result) and eliminate the cause of the cancellation.
C405H	The protocol number set value is out of range in the control data of the SP.ECPRTCL instruction.	Correct the protocol number set value.
C410H	The receive waiting time timed out.	<ul style="list-style-type: none"> • Check if the cable is disconnected. • Correct the specified connection number of the external device connection configuration setting, and execute the protocol again. • Check that there is no error in the external device. • Check that the sending from the external device is not interrupted. • Check that there is no data lost due to a receive error. • Check that there is no error in the data (packet) sent by the external device.
C411H	The received data is larger than 2046 bytes.	<ul style="list-style-type: none"> • Check the data sent from the external device. • When sending data larger than 2046 bytes from the external device, divide the data into several portions and execute data sending several times.
C417H	The data length or data quantity of the received data is out of range.	<ul style="list-style-type: none"> • Check the maximum allowable data length and specify the maximum length or less in the data length storage area. • Check the maximum allowable data quantity, and specify the maximum quantity or less in the data quantity storage area.
C431H	The connection was closed during the SP.ECPRTCL instruction execution.	<ul style="list-style-type: none"> • Check the operation of the external device. • Check the connection open status with the external device. • Open the connection with the external device again and execute the instruction.

SLMP function error code

3E frame

■Error codes returned to target device during data communication

Error codes stored when communication ends in error during SLMP (3E frame) are as provided in the following table.

Error code (Hexadecimal)	Error details and causes	Action
4000H to 4FFFH	Errors detected by CPU module. (Errors that occurred in other than SLMP communication function)	Refer to MELSEC iQ-F FX5 User's Manual(Application) and take appropriate measures.
C050H	When the communication data code is set to "ASCII", ASCII code data which cannot be converted to binary is received.	<ul style="list-style-type: none"> For communication, set to "Binary" in the communication data code and restart the CPU module. Correct the send data from the target device and send it.
C051H	Maximum number of bit devices for which data can be read/written all at once is outside the allowable range.	Correct number of bit devices that can be read or written all at once, and send to CPU module again.
C052H	Maximum number of word devices for which data can be read/written all at once is outside the allowable range.	Correct number of word devices that can read or write all at once, and send to CPU module again.
C053H	Maximum number of bit devices for which data can be random read/written all at once is outside the allowable range.	Correct number of bit devices that can be random read or written all at once, and send to CPU module again.
C054H	Maximum number of word devices for which data can be random read/written all at once is outside the allowable range.	Correct number of word devices that can be random read or written all at once, and send to CPU module again.
C056H	Read or write request exceeds maximum address.	Correct starting address or number of read and write points, and send to CPU module again. (Be careful not to exceed the maximum address.)
C058H	Request data length after ASCII-to-binary conversion does not match the number of data in the character section (part of text).	After reviewing and correcting content of text or length of request data in the header, send to CPU module again.
C059H	<ul style="list-style-type: none"> Error in command or subcommand specification. There is a command or subcommand that cannot be used by the CPU module. 	<ul style="list-style-type: none"> Reconsider request contents. Send command or subcommand that can be used by the CPU module.
C05BH	CPU module cannot read or write from/to specified device.	Reconsider device to read or write.
C05CH	Error in request contents. (Reading or writing by bit unit for word device, etc.)	Correct request content, and send to CPU module again. (Subcommand correction, etc.)
C05FH	There is a request that cannot be executed for the target CPU module.	<ul style="list-style-type: none"> Correct network No., request station No., request destination module I/O No., or request destination module station No. Correct contents of write request and/or read request.
C060H	Error in request contents. (Error in specification of data for bit device, etc.)	Correct request content, and send to CPU module again. (Data correction, etc.)
C061H	Request data length does not match the number of data in the character section (part of text).	After reconsidering and correcting content of text or length of request data in the header, send to CPU module again.
C06FH	When the communication data code is set to "Binary", a request message of ASCII is received. (Error history of this error code is registered but no error response is sent.)	<ul style="list-style-type: none"> Sent a request message which matches the setting of the communication data code. Change the communication data code to match the request message.
C0D8H	The number of specified blocks exceeds the range.	Correct the specified value of for the number of blocks.
C200H	Error in remote password.	Correct remote password, and re-execute remote password lock and unlock.
C201H	Locked status of the remote password of the port which is used for communication.	Unlock the remote password before data communication.
C204H	Different device requested remote password to be unlocked.	Request remote password lock from device that requested unlock of remote password.
C810H	Error in remote password. (Authentication failure count is 9 or less.)	Correct remote password, and re-execute remote password unlock.
C815H	Error in remote password. (Authentication failure count is 10.)	Re-execute remote password unlock after the specified time elapses.
C816H	Remote password authentication is locked out.	Re-execute remote password unlock after the specified time elapses.

10.4 Troubleshooting Flowchart

Simple troubleshooting when communication cannot be carried out between built-in Ethernet and other device is provided in the form of a flowchart.

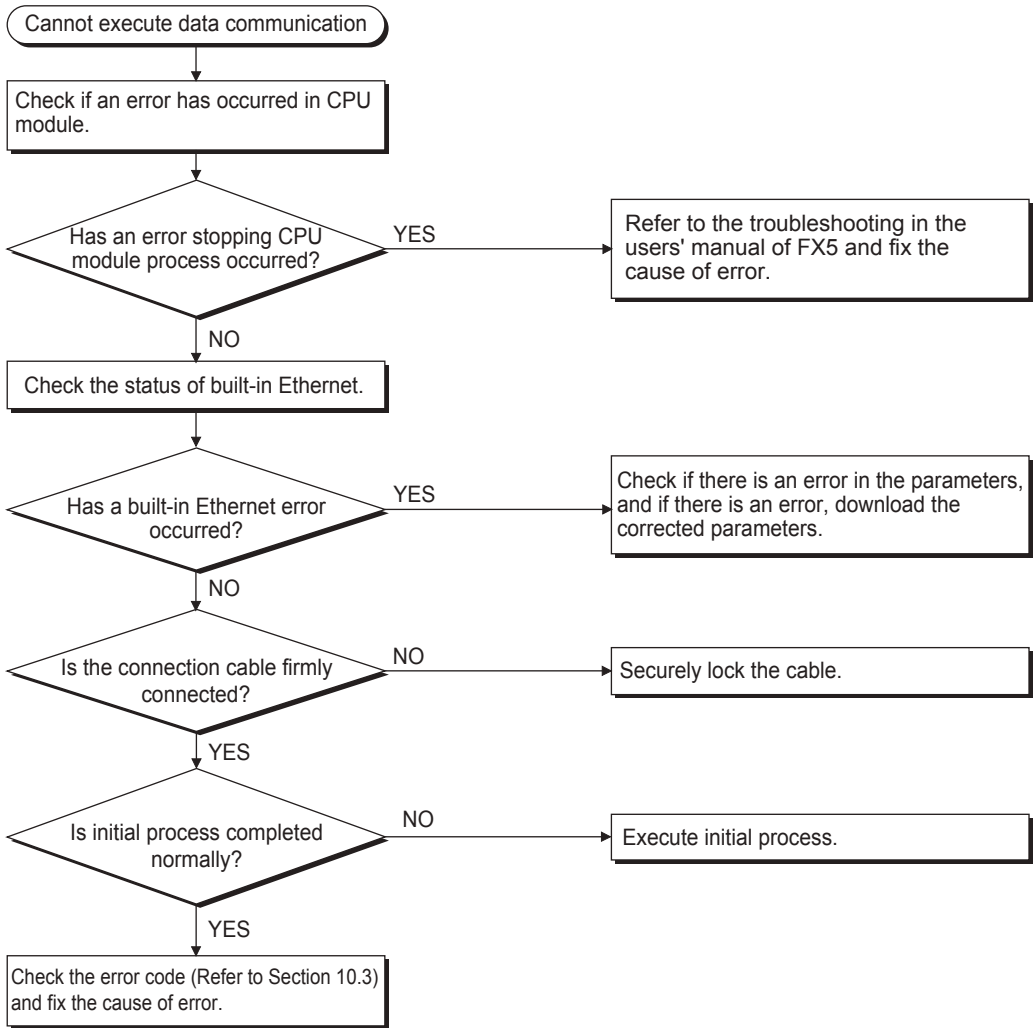

Point

- If trouble occurs while using built-in Ethernet, check the error status with the Ethernet diagnostics function of GX Works3. For error contents, refer to Page 110 Error codes of the Ethernet communication.
- For information concerning when the [ERR] LED is lit, refer to Page 104 Checking Errors by LEDs.
- If CPU module is replaced due to error occurrence, reboot all target devices with which communication was being done, and restart data communication. (If target device retains Ethernet address of communication target, continuation of communication may not be possible in some cases because Ethernet address changes when the CPU module is replaced (includes unit-specific addresses such as MAC address.)
- If target device (such as a personal computer) is replaced, turn CPU module's power OFF→ON and/or perform system reset.
- If message transmitted from target device cannot be received by built-in Ethernet (error log is long) frequently, there may be a large load on the Ethernet line due to data transmitted among the various devices connected. In order to reduce load on the Ethernet line, you may have to take measures such as dividing the network or reduce the number of data transmissions. After conferring with the network administrator, reduce the load on the Ethernet line.
- When the ground terminal of the CPU module cannot be grounded, the communication line may be closed due to the effects of noise, making it impossible to communicate with other devices.

Errors during SLMP communication

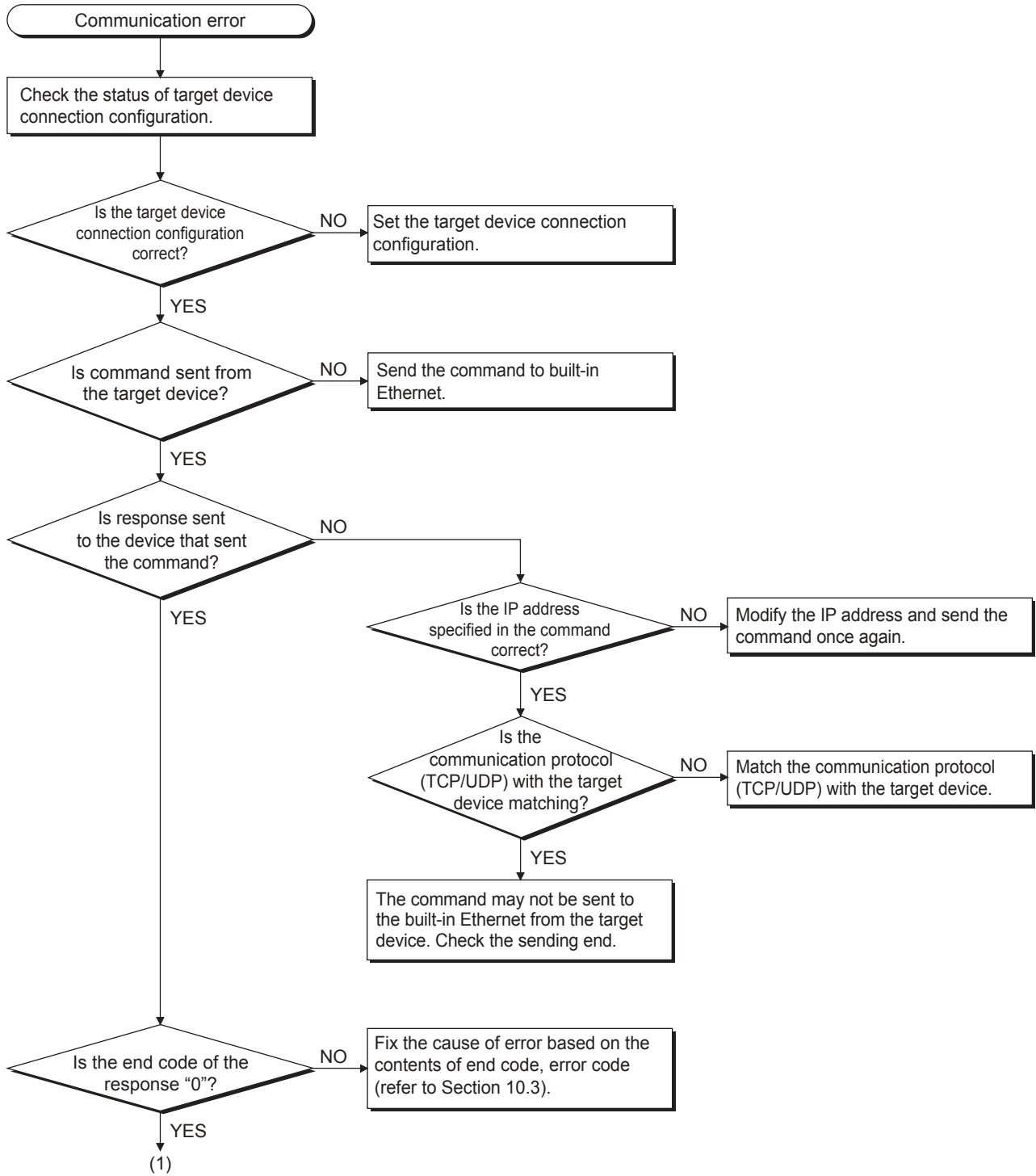

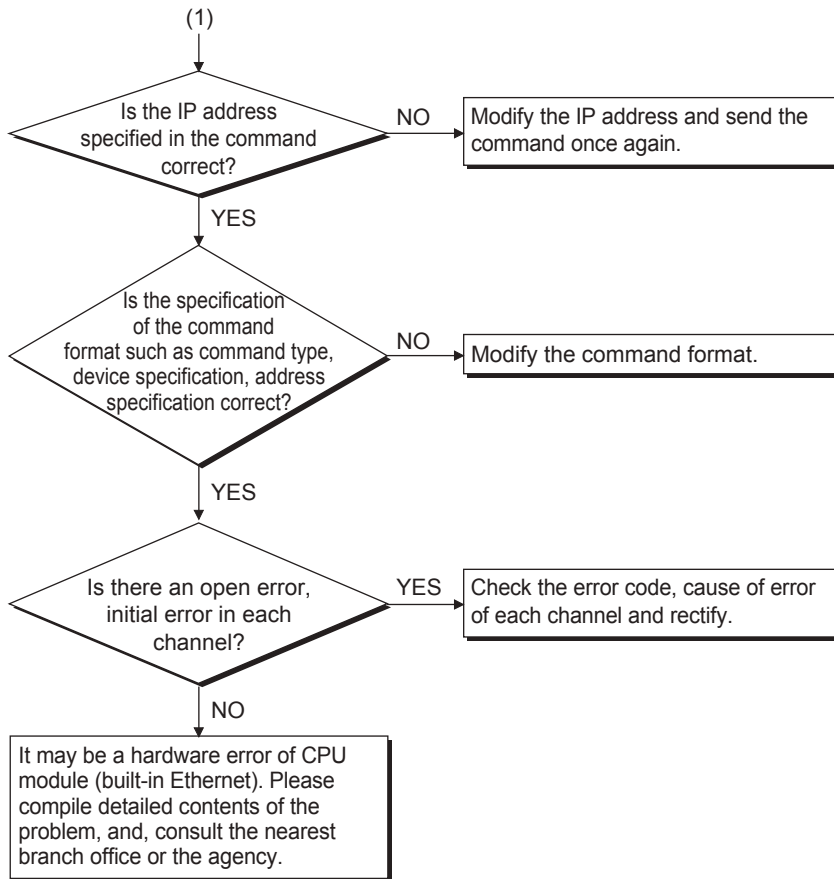

APPENDIX

Appendix 1 List of Special Device Applications and Assignments

For special relays and special registers other than described below, refer to  MELSEC iQ-F FX5 User's Manual(Application).

Special relays

Device No.	Name	Description	R/W
SM8492	IP address storage area write request	Writes IP address setting stored in SD8492 to SD8497 to IP address storage area when this device turns from OFF to ON.	R/W
SM8493	IP address storage area write completed	<ul style="list-style-type: none"> • Turns ON when writing to IP address storage area completes or fails. • Turns OFF when IP address storage area write request (SM8492) turns from ON to OFF. 	R
SM8494	IP address storage area write error	<ul style="list-style-type: none"> • Turns ON when writing to IP address storage area fails. • Turns ON if there is a problem in contents of IP address storage area, when PLC power supply is turned from OFF to ON. • Turns OFF when IP address storage area write request (SM8492) turns from ON to OFF. 	R
SM8495	IP address storage area clear request	Contents of IP address storage area are cleared when this device turns from OFF to ON.	R/W
SM8496	IP address storage area clear completed	<ul style="list-style-type: none"> • Turns ON when clearing of IP address storage area completes or fails. • Turns OFF when IP address storage area clear request (SM8495) turns from ON to OFF. 	R
SM8497	IP address storage area clear error	<ul style="list-style-type: none"> • Turns ON when clearing of IP address storage area fails. • Turns OFF when IP address storage area clear request (SM8495) turns from ON to OFF. 	R
SM8498	IP address change function enable flag	Turns ON when IP address is changed by IP address change function.	R

R: Read only, R/W: Read/Write

Special registers

Device No.	Name	Description	R/W
SD8492	IP address setting (Low-order)	<ul style="list-style-type: none"> • Stores IP address (low-order) to be set when using IP address change function. • Becomes 0 when writing to IP address storage area is completed normally. 	R/W
SD8493	IP address setting (High-order)	<ul style="list-style-type: none"> • Stores IP address (high-order) to be set when using IP address change function. • Becomes 0 when writing to IP address storage area is completed normally. 	R/W
SD8494	Subnet mask setting (Low-order)	<ul style="list-style-type: none"> • Stores subnet mask (low-order) to be set when using IP address change function. • Becomes 0 when writing to IP address storage area is completed normally. 	R/W
SD8495	Subnet mask setting (High-order)	<ul style="list-style-type: none"> • Stores subnet mask (high-order) to be set when using IP address change function. • Becomes 0 when writing to IP address storage area is completed normally. 	R/W
SD8496	Default gateway IP address setting (Low-order)	<ul style="list-style-type: none"> • Stores default gateway IP address (low-order) to be set when using IP address change function. • Becomes 0 when writing to IP address storage area is completed normally. 	R/W
SD8497	Default gateway IP address setting (High-order)	<ul style="list-style-type: none"> • Stores default gateway IP address (high-order) to be set when using IP address change function. • Becomes 0 when writing to IP address storage area is completed normally. 	R/W
SD8498	IP address storage area write error code	Stores error codes if writing to IP address storage area fails.	R
SD8499	IP address storage area clear error code	Stores error codes if clearing of IP address storage area fails.	R
SD10050	IP address (Low-order)	Lower part of the IP address.	R
SD10051	IP address (High-order)	Higher part of the IP address.	R
SD10060	Subnet mask (Low-order)	Lower part of the subnet mask setting value.	R
SD10061	Subnet mask (High-order)	Higher part of the subnet mask setting value.	R

Device No.	Name	Description	R/W
SD10064	Default gateway IP address (Low-order)	Lower part of the default gateway IP address setting value.	R
SD10065	Default gateway IP address (High-order)	Higher part of the default gateway IP address setting value.	R
SD10074 to SD10076	Host MAC address	MAC address (3 words in total) is stored.	R
SD10082	Communication speed setting	Communication speed setting is stored. 0000H: Automatic Negotiation 0002H: 100Mbps/Half-Duplex 0003H: 100Mbps/Full-Duplex 0004H: 10Mbps/Half-Duplex 0005H: 10Mbps/Full-Duplex	R
SD10084	MELSOFT connection TCP port number	MELSOFT connection TCP port number is stored.	R
SD10086	MELSOFT direct connection port number	MELSOFT direct connection port number is stored.	R
SD10130 to SD10137	Error code	Error codes detected by PLC are stored.	R
SD10270	Remote password information remote password locked status (Connection No. 1 to 8)	Locked status of the remote password for each connection [b0] to [b7]: Connection No. 1 to No. 8 0: Unlocked status/No remote password setting 1: Locked status	R
SD10271	Remote password information remote password locked status (System port)	The locked status of the remote password of the system port. [b2]: MELSOFT application communication port (TCP) [b3]: Direct connection with MELSOFT 0: Unlocked status/No remote password setting 1: Locked status	R
SD10280	Connection forced disabling	Specify this to disable a connection forcibly by user program. (Connection 1 to 8/ MELSOFT connection/Direct connection)	R/W
SD10320 to SD10327	Unlock failure count	Unlock failure counts are stored. [SD10320] to [SD10327]: Connection No. 1 to No. 8	R
SD10338	MELSOFT connection TCP port continuous unlock failure count	Unlock failure counts of the MELSOFT connection (via hub) are stored.	R
SD10340	Direct connection with MELSOFT continuous unlock failure count	Unlock failure counts of the MELSOFT connection (direct connection) are stored.	R
SD10680	Open completion signal	Open completion signal for each connection. [b0] to [b7]: Connection No. 1 to No. 8 0: Closed or not open 1: Open completed	R
SD10681	Open request signal	Open request signal for each connection. [b0] to [b7]: Connection No. 1 to No. 8 0: No open request 1: Requesting open	R
SD10682	Socket communications receive status signal	Socket communication receive state signal for each connection. [b0] to [b7]: Connection No. 1 to No. 8 0: Data not received 1: Data reception completed	R
SD10692	Predefined protocol ready	Stores the ready status of the protocol setting data. 0: — 1: Ready	R
SD10710	Predefined protocol setting data check area protocol number	When a protocol setting data error is detected, stores the protocol number where the error was detected. Protocol is checked in order from smallest protocol number. The protocol number where an error was detected first is stored. 0: No error 1 to 64: Protocol number 65535: Cannot identify*1	R
SD10711	Predefined protocol setting data check area setting type	0 is stored if an error is detected in the packet setting or element setting. 1 is stored if an error is detected in the protocol detailed setting. (Valid when protocol number value is 1 to 128) 0: Packet setting or element setting 1: Protocol preferences 65535: Cannot identify*1	R

Device No.	Name	Description	R/W
SD10712	Predefined protocol setting data check area packet number	When an error is detected in the protocol setting data, stores the packet number that detected the error. The packets are checked in order of send packets and then receive packets (expected packets) from smallest number. The packet number where an error was detected first is stored. (Valid when setting type value is 0) 0: Send packet 1 to 16: Receive packet number 65535: Cannot identify* ¹	R
SD10713	Predefined protocol setting data check area protocol number	When an error is detected in the protocol setting data, stores the element number where the error was detected. The elements are checked in order of smallest element number. The element number where an error was detected first is stored. (Valid when setting type value is 0) 1 to 32: Element number 65535: Cannot identify* ¹	R
SD10714	Number of registered predefined protocols	Stores the protocol number of the registered protocol setting data. 0 is stored if the protocol setting data check result is abnormal. 0: No registration 1 to 64: Number of registrations	R
SD10722	Predefined protocol registration (Protocol numbers 1 to 16)	Whether protocol setting data is registered or not is stored. All bits are set to 0 if the protocol setting data check result is abnormal. [b0] to [b15]: Protocol numbers 1 to 16 0: No registration 1: Registered	R
SD10723	Predefined protocol registration (Protocol numbers 17 to 32)	Whether protocol setting data is registered or not is stored. All bits are set to 0 if the protocol setting data check result is abnormal. [b0] to [b15]: Protocol numbers 17 to 32 0: No registration 1: Registered	R
SD10724	Predefined protocol registration (Protocol numbers 33 to 48)	Whether protocol setting data is registered or not is stored. All bits are set to 0 if the protocol setting data check result is abnormal. [b0] to [b15]: Protocol numbers 33 to 48 0: No registration 1: Registered	R
SD10725	Predefined protocol registration (Protocol numbers 49 to 64)	Whether protocol setting data is registered or not is stored. All bits are set to 0 if the protocol setting data check result is abnormal. [b0] to [b15]: Protocol numbers 49 to 64 0: No registration 1: Registered	R
SD10740	Connection No.1 protocol execution status	Stores the status of the protocol being executed at connection No.1. 0: Unexecuted 1: Waiting for transmission 2: Sending 3: Waiting for data reception 4: Receiving 5: Execution completed	R
SD10742	Connection No.1 received data verification result (receive packet No.1)	Stores the verification results of receive packet No.1. Element No. where the verification result did not match (b0 to b7) The cause of mismatch (verification result code) (b8 to b15)	R
SD10743	Connection No.1 received data verification result (receive packet No.2)	Stores the verification results of receive packet No.2. Element No. where the verification result did not match (b0 to b7) The cause of mismatch (verification result code) (b8 to b15)	R
SD10744	Connection No.1 received data verification result (receive packet No.3)	Stores the verification results of receive packet No.3. Element No. where the verification result did not match (b0 to b7) The cause of mismatch (verification result code) (b8 to b15)	R
SD10745	Connection No.1 received data verification result (receive packet No.4)	Stores the verification results of receive packet No.4. Element No. where the verification result did not match (b0 to b7) The cause of mismatch (verification result code) (b8 to b15)	R
SD10746	Connection No.1 received data verification result (receive packet No.5)	Stores the verification results of receive packet No.5. Element No. where the verification result did not match (b0 to b7) The cause of mismatch (verification result code) (b8 to b15)	R
SD10747	Connection No.1 received data verification result (receive packet No.6)	Stores the verification results of receive packet No.6. Element No. where the verification result did not match (b0 to b7) The cause of mismatch (verification result code) (b8 to b15)	R
SD10748	Connection No.1 received data verification result (receive packet No.7)	Stores the verification results of receive packet No.7. Element No. where the verification result did not match (b0 to b7) The cause of mismatch (verification result code) (b8 to b15)	R

Device No.	Name	Description	R/W
SD10749	Connection No.1 received data verification result (receive packet No.8)	Stores the verification results of receive packet No.8. Element No. where the verification result did not match (b0 to b7) The cause of mismatch (verification result code) (b8 to b15)	R
SD10750	Connection No.1 received data verification result (receive packet No.9)	Stores the verification results of receive packet No.9. Element No. where the verification result did not match (b0 to b7) The cause of mismatch (verification result code) (b8 to b15)	R
SD10751	Connection No.1 received data verification result (receive packet No.10)	Stores the verification results of receive packet No.10. Element No. where the verification result did not match (b0 to b7) The cause of mismatch (verification result code) (b8 to b15)	R
SD10752	Connection No.1 received data verification result (receive packet No.11)	Stores the verification results of receive packet No.11. Element No. where the verification result did not match (b0 to b7) The cause of mismatch (verification result code) (b8 to b15)	R
SD10753	Connection No.1 received data verification result (receive packet No.12)	Stores the verification results of receive packet No.12. Element No. where the verification result did not match (b0 to b7) The cause of mismatch (verification result code) (b8 to b15)	R
SD10754	Connection No.1 received data verification result (receive packet No.13)	Stores the verification results of receive packet No.13. Element No. where the verification result did not match (b0 to b7) The cause of mismatch (verification result code) (b8 to b15)	R
SD10755	Connection No.1 received data verification result (receive packet No.14)	Stores the verification results of receive packet No.14. Element No. where the verification result did not match (b0 to b7) The cause of mismatch (verification result code) (b8 to b15)	R
SD10756	Connection No.1 received data verification result (receive packet No.15)	Stores the verification results of receive packet No.15. Element No. where the verification result did not match (b0 to b7) The cause of mismatch (verification result code) (b8 to b15)	R
SD10757	Connection No.1 received data verification result (receive packet No.16)	Stores the verification results of receive packet No.16. Element No. where the verification result did not match (b0 to b7) The cause of mismatch (verification result code) (b8 to b15)	R
SD10758	Connection No.1 protocol execution count	Stores the number of protocol executions in Connection No.1. 0: Protocol not executed 1 to 65535: Number of executions	R
SD10759	Connection No.1 protocol cancellation specification	Cancels the protocol executed in connection No.1. 0: No cancellation instruction 1: Cancellation request (set by user) 2: Cancellation completed (set by system)	R/W
SD10760	Connection No.2 protocol execution status	Stores the status of the protocol being executed at connection No.2. 0: Unexecuted 1: Waiting for transmission 2: Sending 3: Waiting for data reception 4: Receiving 5: Execution completed	R
SD10762	Connection No.2 received data verification result (receive packet No.1)	Stores the verification results of receive packet No.1. Element No. where the verification result did not match (b0 to b7) The cause of mismatch (verification result code) (b8 to b15)	R
SD10763	Connection No.2 received data verification result (receive packet No.2)	Stores the verification results of receive packet No.2. Element No. where the verification result did not match (b0 to b7) The cause of mismatch (verification result code) (b8 to b15)	R
SD10764	Connection No.2 received data verification result (receive packet No.3)	Stores the verification results of receive packet No.3. Element No. where the verification result did not match (b0 to b7) The cause of mismatch (verification result code) (b8 to b15)	R
SD10765	Connection No.2 received data verification result (receive packet No.4)	Stores the verification results of receive packet No.4. Element No. where the verification result did not match (b0 to b7) The cause of mismatch (verification result code) (b8 to b15)	R
SD10766	Connection No.2 received data verification result (receive packet No.5)	Stores the verification results of receive packet No.5. Element No. where the verification result did not match (b0 to b7) The cause of mismatch (verification result code) (b8 to b15)	R
SD10767	Connection No.2 received data verification result (receive packet No.6)	Stores the verification results of receive packet No.6. Element No. where the verification result did not match (b0 to b7) The cause of mismatch (verification result code) (b8 to b15)	R
SD10768	Connection No.2 received data verification result (receive packet No.7)	Stores the verification results of receive packet No.7. Element No. where the verification result did not match (b0 to b7) The cause of mismatch (verification result code) (b8 to b15)	R

Device No.	Name	Description	R/W
SD10769	Connection No.2 received data verification result (receive packet No.8)	Stores the verification results of receive packet No.8. Element No. where the verification result did not match (b0 to b7) The cause of mismatch (verification result code) (b8 to b15)	R
SD10770	Connection No.2 received data verification result (receive packet No.9)	Stores the verification results of receive packet No.9. Element No. where the verification result did not match (b0 to b7) The cause of mismatch (verification result code) (b8 to b15)	R
SD10771	Connection No.2 received data verification result (receive packet No.10)	Stores the verification results of receive packet No.10. Element No. where the verification result did not match (b0 to b7) The cause of mismatch (verification result code) (b8 to b15)	R
SD10772	Connection No.2 received data verification result (receive packet No.11)	Stores the verification results of receive packet No.11. Element No. where the verification result did not match (b0 to b7) The cause of mismatch (verification result code) (b8 to b15)	R
SD10773	Connection No.2 received data verification result (receive packet No.12)	Stores the verification results of receive packet No.12. Element No. where the verification result did not match (b0 to b7) The cause of mismatch (verification result code) (b8 to b15)	R
SD10774	Connection No.2 received data verification result (receive packet No.13)	Stores the verification results of receive packet No.13. Element No. where the verification result did not match (b0 to b7) The cause of mismatch (verification result code) (b8 to b15)	R
SD10775	Connection No.2 received data verification result (receive packet No.14)	Stores the verification results of receive packet No.14. Element No. where the verification result did not match (b0 to b7) The cause of mismatch (verification result code) (b8 to b15)	R
SD10776	Connection No.2 received data verification result (receive packet No.15)	Stores the verification results of receive packet No.15. Element No. where the verification result did not match (b0 to b7) The cause of mismatch (verification result code) (b8 to b15)	R
SD10777	Connection No.2 received data verification result (receive packet No.16)	Stores the verification results of receive packet No.16. Element No. where the verification result did not match (b0 to b7) The cause of mismatch (verification result code) (b8 to b15)	R
SD10778	Connection No.2 protocol execution count	Stores the number of protocol executions in connection No.2. 0: Protocol not executed 1 to 65535: Number of executions	R
SD10779	Connection No.2 protocol cancellation specification	Cancels the protocol executed in connection No.2. 0: No cancellation instruction 1: Cancellation request (set by user) 2: Cancellation completed (set by system)	R/W
SD10780	Connection No.3 protocol execution status	Stores the status of the protocol being executed at connection No.3. 0: Unexecuted 1: Waiting for transmission 2: Sending 3: Waiting for data reception 4: Receiving 5: Execution completed	R
SD10782	Connection No.3 received data verification result (receive packet No.1)	Stores the verification results of receive packet No.1. Element No. where the verification result did not match (b0 to b7) The cause of mismatch (verification result code) (b8 to b15)	R
SD10783	Connection No.3 received data verification result (receive packet No.2)	Stores the verification results of receive packet No.2. Element No. where the verification result did not match (b0 to b7) The cause of mismatch (verification result code) (b8 to b15)	R
SD10784	Connection No.3 received data verification result (receive packet No.3)	Stores the verification results of receive packet No.3. Element No. where the verification result did not match (b0 to b7) The cause of mismatch (verification result code) (b8 to b15)	R
SD10785	Connection No.3 received data verification result (receive packet No.4)	Stores the verification results of receive packet No.4. Element No. where the verification result did not match (b0 to b7) The cause of mismatch (verification result code) (b8 to b15)	R
SD10786	Connection No.3 received data verification result (receive packet No.5)	Stores the verification results of receive packet No.5. Element No. where the verification result did not match (b0 to b7) The cause of mismatch (verification result code) (b8 to b15)	R
SD10787	Connection No.3 received data verification result (receive packet No.6)	Stores the verification results of receive packet No.6. Element No. where the verification result did not match (b0 to b7) The cause of mismatch (verification result code) (b8 to b15)	R
SD10788	Connection No.3 received data verification result (receive packet No.7)	Stores the verification results of receive packet No.7. Element No. where the verification result did not match (b0 to b7) The cause of mismatch (verification result code) (b8 to b15)	R

Device No.	Name	Description	R/W
SD10789	Connection No.3 received data verification result (receive packet No.8)	Stores the verification results of receive packet No.8. Element No. where the verification result did not match (b0 to b7) The cause of mismatch (verification result code) (b8 to b15)	R
SD10790	Connection No.3 received data verification result (receive packet No.9)	Stores the verification results of receive packet No.9. Element No. where the verification result did not match (b0 to b7) The cause of mismatch (verification result code) (b8 to b15)	R
SD10791	Connection No.3 received data verification result (receive packet No.10)	Stores the verification results of receive packet No.10. Element No. where the verification result did not match (b0 to b7) The cause of mismatch (verification result code) (b8 to b15)	R
SD10792	Connection No.3 received data verification result (receive packet No.11)	Stores the verification results of receive packet No.11. Element No. where the verification result did not match (b0 to b7) The cause of mismatch (verification result code) (b8 to b15)	R
SD10793	Connection No.3 received data verification result (receive packet No.12)	Stores the verification results of receive packet No.12. Element No. where the verification result did not match (b0 to b7) The cause of mismatch (verification result code) (b8 to b15)	R
SD10794	Connection No.3 received data verification result (receive packet No.13)	Stores the verification results of receive packet No.13. Element No. where the verification result did not match (b0 to b7) The cause of mismatch (verification result code) (b8 to b15)	R
SD10795	Connection No.3 received data verification result (receive packet No.14)	Stores the verification results of receive packet No.14. Element No. where the verification result did not match (b0 to b7) The cause of mismatch (verification result code) (b8 to b15)	R
SD10796	Connection No.3 received data verification result (receive packet No.15)	Stores the verification results of receive packet No.15. Element No. where the verification result did not match (b0 to b7) The cause of mismatch (verification result code) (b8 to b15)	R
SD10797	Connection No.3 received data verification result (receive packet No.16)	Stores the verification results of receive packet No.16. Element No. where the verification result did not match (b0 to b7) The cause of mismatch (verification result code) (b8 to b15)	R
SD10798	Connection No.3 protocol execution count	Stores the number of protocol executions in connection No.3. 0: Protocol not executed 1 to 65535: Number of executions	R
SD10799	Connection No.3 protocol cancellation specification	0: No cancellation instruction 1: Cancellation request (set by user) 2: Cancellation completed (set by system)	R/W
SD10800	Connection No.4 protocol execution status	0: Unexecuted 1: Waiting for transmission 2: Sending 3: Waiting for data reception 4: Receiving 5: Execution completed	R
SD10802	Connection No.4 received data verification result (receive packet No.1)	Stores the verification results of receive packet No.1. Element No. where the verification result did not match (b0 to b7) The cause of mismatch (verification result code) (b8 to b15)	R
SD10803	Connection No.4 received data verification result (receive packet No.2)	Stores the verification results of receive packet No.2. Element No. where the verification result did not match (b0 to b7) The cause of mismatch (verification result code) (b8 to b15)	R
SD10804	Connection No.4 received data verification result (receive packet No.3)	Stores the verification results of receive packet No.3. Element No. where the verification result did not match (b0 to b7) The cause of mismatch (verification result code) (b8 to b15)	R
SD10805	Connection No.4 received data verification result (receive packet No.4)	Stores the verification results of receive packet No.4. Element No. where the verification result did not match (b0 to b7) The cause of mismatch (verification result code) (b8 to b15)	R
SD10806	Connection No.4 received data verification result (receive packet No.5)	Stores the verification results of receive packet No.5. Element No. where the verification result did not match (b0 to b7) The cause of mismatch (verification result code) (b8 to b15)	R
SD10807	Connection No.4 received data verification result (receive packet No.6)	Stores the verification results of receive packet No.6. Element No. where the verification result did not match (b0 to b7) The cause of mismatch (verification result code) (b8 to b15)	R
SD10808	Connection No.4 received data verification result (receive packet No.7)	Stores the verification results of receive packet No.7. Element No. where the verification result did not match (b0 to b7) The cause of mismatch (verification result code) (b8 to b15)	R

Device No.	Name	Description	R/W
SD10809	Connection No.4 received data verification result (receive packet No.8)	Stores the verification results of receive packet No.8. Element No. where the verification result did not match (b0 to b7) The cause of mismatch (verification result code) (b8 to b15)	R
SD10810	Connection No.4 received data verification result (receive packet No.9)	Stores the verification results of receive packet No.9. Element No. where the verification result did not match (b0 to b7) The cause of mismatch (verification result code) (b8 to b15)	R
SD10811	Connection No.4 received data verification result (receive packet No.10)	Stores the verification results of receive packet No.10. Element No. where the verification result did not match (b0 to b7) The cause of mismatch (verification result code) (b8 to b15)	R
SD10812	Connection No.4 received data verification result (receive packet No.11)	Stores the verification results of receive packet No.11. Element No. where the verification result did not match (b0 to b7) The cause of mismatch (verification result code) (b8 to b15)	R
SD10813	Connection No.4 received data verification result (receive packet No.12)	Stores the verification results of receive packet No.12. Element No. where the verification result did not match (b0 to b7) The cause of mismatch (verification result code) (b8 to b15)	R
SD10814	Connection No.4 received data verification result (receive packet No.13)	Stores the verification results of receive packet No.13. Element No. where the verification result did not match (b0 to b7) The cause of mismatch (verification result code) (b8 to b15)	R
SD10815	Connection No.4 received data verification result (receive packet No.14)	Stores the verification results of receive packet No.14. Element No. where the verification result did not match (b0 to b7) The cause of mismatch (verification result code) (b8 to b15)	R
SD10816	Connection No.4 received data verification result (receive packet No.15)	Stores the verification results of receive packet No.15. Element No. where the verification result did not match (b0 to b7) The cause of mismatch (verification result code) (b8 to b15)	R
SD10817	Connection No.4 received data verification result (receive packet No.16)	Stores the verification results of receive packet No.16. Element No. where the verification result did not match (b0 to b7) The cause of mismatch (verification result code) (b8 to b15)	R
SD10818	Connection No.4 protocol execution count	Stores the number of protocol executions in connection No.4. 0: Protocol not executed 1 to 65535: Number of executions	R
SD10819	Connection No.4 protocol cancellation specification	Cancels the protocol executed in connection No.4. 0: No cancellation instruction 1: Cancellation request (set by user) 2: Cancellation completed (set by system)	R/W
SD10820	Connection No.5 protocol execution status	Stores the status of the protocol being executed at connection No.5. 0: Unexecuted 1: Waiting for transmission 2: Sending 3: Waiting for data reception 4: Receiving 5: Execution completed	R
SD10822	Connection No.5 received data verification result (receive packet No.1)	Stores the verification results of receive packet No.1. Element No. where the verification result did not match (b0 to b7) The cause of mismatch (verification result code) (b8 to b15)	R
SD10823	Connection No.5 received data verification result (receive packet No.2)	Stores the verification results of receive packet No.2. Element No. where the verification result did not match (b0 to b7) The cause of mismatch (verification result code) (b8 to b15)	R
SD10824	Connection No.5 received data verification result (receive packet No.3)	Stores the verification results of receive packet No.3. Element No. where the verification result did not match (b0 to b7) The cause of mismatch (verification result code) (b8 to b15)	R
SD10825	Connection No.5 received data verification result (receive packet No.4)	Stores the verification results of receive packet No.4. Element No. where the verification result did not match (b0 to b7) The cause of mismatch (verification result code) (b8 to b15)	R
SD10826	Connection No.5 received data verification result (receive packet No.5)	Stores the verification results of receive packet No.5. Element No. where the verification result did not match (b0 to b7) The cause of mismatch (verification result code) (b8 to b15)	R
SD10827	Connection No.5 received data verification result (receive packet No.6)	Stores the verification results of receive packet No.6. Element No. where the verification result did not match (b0 to b7) The cause of mismatch (verification result code) (b8 to b15)	R
SD10828	Connection No.5 received data verification result (receive packet No.7)	Stores the verification results of receive packet No.7. Element No. where the verification result did not match (b0 to b7) The cause of mismatch (verification result code) (b8 to b15)	R

Device No.	Name	Description	R/W
SD10829	Connection No.5 received data verification result (receive packet No.8)	Stores the verification results of receive packet No.8. Element No. where the verification result did not match (b0 to b7) The cause of mismatch (verification result code) (b8 to b15)	R
SD10830	Connection No.5 received data verification result (receive packet No.9)	Stores the verification results of receive packet No.9. Element No. where the verification result did not match (b0 to b7) The cause of mismatch (verification result code) (b8 to b15)	R
SD10831	Connection No.5 received data verification result (receive packet No.10)	Stores the verification results of receive packet No.10. Element No. where the verification result did not match (b0 to b7) The cause of mismatch (verification result code) (b8 to b15)	R
SD10832	Connection No.5 received data verification result (receive packet No.11)	Stores the verification results of receive packet No.11. Element No. where the verification result did not match (b0 to b7) The cause of mismatch (verification result code) (b8 to b15)	R
SD10833	Connection No.5 received data verification result (receive packet No.12)	Stores the verification results of receive packet No.12. Element No. where the verification result did not match (b0 to b7) The cause of mismatch (verification result code) (b8 to b15)	R
SD10834	Connection No.5 received data verification result (receive packet No.13)	Stores the verification results of receive packet No.13. Element No. where the verification result did not match (b0 to b7) The cause of mismatch (verification result code) (b8 to b15)	R
SD10835	Connection No.5 received data verification result (receive packet No.14)	Stores the verification results of receive packet No.14. Element No. where the verification result did not match (b0 to b7) The cause of mismatch (verification result code) (b8 to b15)	R
SD10836	Connection No.5 received data verification result (receive packet No.15)	Stores the verification results of receive packet No.15. Element No. where the verification result did not match (b0 to b7) The cause of mismatch (verification result code) (b8 to b15)	R
SD10837	Connection No.5 received data verification result (receive packet No.16)	Stores the verification results of receive packet No.16. Element No. where the verification result did not match (b0 to b7) The cause of mismatch (verification result code) (b8 to b15)	R
SD10838	Connection No.5 protocol execution count	Stores the number of protocol executions in connection No.5. 0: Protocol not executed 1 to 65535: Number of executions	R
SD10839	Connection No.5 protocol cancellation specification	Cancels the protocol executed in connection No.5. 0: No cancellation instruction 1: Cancellation request (set by user) 2: Cancellation completed (set by system)	R/W
SD10840	Connection No.6 protocol execution status	Stores the status of the protocol being executed at connection No.6. 0: Unexecuted 1: Waiting for transmission 2: Sending 3: Waiting for data reception 4: Receiving 5: Execution completed	R
SD10842	Connection No.6 received data verification result (receive packet No.1)	Stores the verification results of receive packet No.1. Element No. where the verification result did not match (b0 to b7) The cause of mismatch (verification result code) (b8 to b15)	R
SD10843	Connection No.6 received data verification result (receive packet No.2)	Stores the verification results of receive packet No.2. Element No. where the verification result did not match (b0 to b7) The cause of mismatch (verification result code) (b8 to b15)	R
SD10844	Connection No.6 received data verification result (receive packet No.3)	Stores the verification results of receive packet No.3. Element No. where the verification result did not match (b0 to b7) The cause of mismatch (verification result code) (b8 to b15)	R
SD10845	Connection No.6 received data verification result (receive packet No.4)	Stores the verification results of receive packet No.4. Element No. where the verification result did not match (b0 to b7) The cause of mismatch (verification result code) (b8 to b15)	R
SD10846	Connection No.6 received data verification result (receive packet No.5)	Stores the verification results of receive packet No.5. Element No. where the verification result did not match (b0 to b7) The cause of mismatch (verification result code) (b8 to b15)	R
SD10847	Connection No.6 received data verification result (receive packet No.6)	Stores the verification results of receive packet No.6. Element No. where the verification result did not match (b0 to b7) The cause of mismatch (verification result code) (b8 to b15)	R
SD10848	Connection No.6 received data verification result (receive packet No.7)	Stores the verification results of receive packet No.7. Element No. where the verification result did not match (b0 to b7) The cause of mismatch (verification result code) (b8 to b15)	R

Device No.	Name	Description	R/W
SD10849	Connection No.6 received data verification result (receive packet No.8)	Stores the verification results of receive packet No.8. Element No. where the verification result did not match (b0 to b7) The cause of mismatch (verification result code) (b8 to b15)	R
SD10850	Connection No.6 received data verification result (receive packet No.9)	Stores the verification results of receive packet No.9. Element No. where the verification result did not match (b0 to b7) The cause of mismatch (verification result code) (b8 to b15)	R
SD10851	Connection No.6 received data verification result (receive packet No.10)	Stores the verification results of receive packet No.10. Element No. where the verification result did not match (b0 to b7) The cause of mismatch (verification result code) (b8 to b15)	R
SD10852	Connection No.6 received data verification result (receive packet No.11)	Stores the verification results of receive packet No.11. Element No. where the verification result did not match (b0 to b7) The cause of mismatch (verification result code) (b8 to b15)	R
SD10853	Connection No.6 received data verification result (receive packet No.12)	Stores the verification results of receive packet No.12. Element No. where the verification result did not match (b0 to b7) The cause of mismatch (verification result code) (b8 to b15)	R
SD10854	Connection No.6 received data verification result (receive packet No.13)	Stores the verification results of receive packet No.13. Element No. where the verification result did not match (b0 to b7) The cause of mismatch (verification result code) (b8 to b15)	R
SD10855	Connection No.6 received data verification result (receive packet No.14)	Stores the verification results of receive packet No.14. Element No. where the verification result did not match (b0 to b7) The cause of mismatch (verification result code) (b8 to b15)	R
SD10856	Connection No.6 received data verification result (receive packet No.15)	Stores the verification results of receive packet No.15. Element No. where the verification result did not match (b0 to b7) The cause of mismatch (verification result code) (b8 to b15)	R
SD10857	Connection No.6 received data verification result (receive packet No.16)	Stores the verification results of receive packet No.16. Element No. where the verification result did not match (b0 to b7) The cause of mismatch (verification result code) (b8 to b15)	R
SD10858	Connection No.6 protocol execution count	Stores the number of protocol executions in connection No.6. 0: Protocol not executed 1 to 65535: Number of executions	R
SD10859	Connection No.6 protocol cancellation specification	Cancels the protocol executed in connection No.6. 0: No cancellation instruction 1: Cancellation request (set by user) 2: Cancellation completed (set by system)	R/W
SD10860	Connection No.7 protocol execution status	Stores the status of the protocol being executed at connection No.7. 0: Unexecuted 1: Waiting for transmission 2: Sending 3: Waiting for data reception 4: Receiving 5: Execution completed	R
SD10862	Connection No.7 received data verification result (receive packet No.1)	Stores the verification results of receive packet No.1. Element No. where the verification result did not match (b0 to b7) The cause of mismatch (verification result code) (b8 to b15)	R
SD10863	Connection No.7 received data verification result (receive packet No.2)	Stores the verification results of receive packet No.2. Element No. where the verification result did not match (b0 to b7) The cause of mismatch (verification result code) (b8 to b15)	R
SD10864	Connection No.7 received data verification result (receive packet No.3)	Stores the verification results of receive packet No.3. Element No. where the verification result did not match (b0 to b7) The cause of mismatch (verification result code) (b8 to b15)	R
SD10865	Connection No.7 received data verification result (receive packet No.4)	Stores the verification results of receive packet No.4. Element No. where the verification result did not match (b0 to b7) The cause of mismatch (verification result code) (b8 to b15)	R
SD10866	Connection No.7 received data verification result (receive packet No.5)	Stores the verification results of receive packet No.5. Element No. where the verification result did not match (b0 to b7) The cause of mismatch (verification result code) (b8 to b15)	R
SD10867	Connection No.7 received data verification result (receive packet No.6)	Stores the verification results of receive packet No.6. Element No. where the verification result did not match (b0 to b7) The cause of mismatch (verification result code) (b8 to b15)	R
SD10868	Connection No.7 received data verification result (receive packet No.7)	Stores the verification results of receive packet No.7. Element No. where the verification result did not match (b0 to b7) The cause of mismatch (verification result code) (b8 to b15)	R

Device No.	Name	Description	R/W
SD10869	Connection No.7 received data verification result (receive packet No.8)	Stores the verification results of receive packet No.8. Element No. where the verification result did not match (b0 to b7) The cause of mismatch (verification result code) (b8 to b15)	R
SD10870	Connection No.7 received data verification result (receive packet No.9)	Stores the verification results of receive packet No.9. Element No. where the verification result did not match (b0 to b7) The cause of mismatch (verification result code) (b8 to b15)	R
SD10871	Connection No.7 received data verification result (receive packet No.10)	Stores the verification results of receive packet No.10. Element No. where the verification result did not match (b0 to b7) The cause of mismatch (verification result code) (b8 to b15)	R
SD10872	Connection No.7 received data verification result (receive packet No.11)	Stores the verification results of receive packet No.11. Element No. where the verification result did not match (b0 to b7) The cause of mismatch (verification result code) (b8 to b15)	R
SD10873	Connection No.7 received data verification result (receive packet No.12)	Stores the verification results of receive packet No.12. Element No. where the verification result did not match (b0 to b7) The cause of mismatch (verification result code) (b8 to b15)	R
SD10874	Connection No.7 received data verification result (receive packet No.13)	Stores the verification results of receive packet No.13. Element No. where the verification result did not match (b0 to b7) The cause of mismatch (verification result code) (b8 to b15)	R
SD10875	Connection No.7 received data verification result (receive packet No.14)	Stores the verification results of receive packet No.14. Element No. where the verification result did not match (b0 to b7) The cause of mismatch (verification result code) (b8 to b15)	R
SD10876	Connection No.7 received data verification result (receive packet No.15)	Stores the verification results of receive packet No.15. Element No. where the verification result did not match (b0 to b7) The cause of mismatch (verification result code) (b8 to b15)	R
SD10877	Connection No.7 received data verification result (receive packet No.16)	Stores the verification results of receive packet No.16. Element No. where the verification result did not match (b0 to b7) The cause of mismatch (verification result code) (b8 to b15)	R
SD10878	Connection No.7 protocol execution count	Stores the number of protocol executions in connection No.7. 0: Protocol not executed 1 to 65535: Number of executions	R
SD10879	Connection No.7 protocol cancellation specification	0: No cancellation instruction 1: Cancellation request (set by user) 2: Cancellation completed (set by system)	R/W
SD10880	Connection No.8 protocol execution status	0: Unexecuted 1: Waiting for transmission 2: Sending 3: Waiting for data reception 4: Receiving 5: Execution completed	R
SD10882	Connection No.8 received data verification result (receive packet No.1)	Stores the verification results of receive packet No.1. Element No. where the verification result did not match (b0 to b7) The cause of mismatch (verification result code) (b8 to b15)	R
SD10883	Connection No.8 received data verification result (receive packet No.2)	Stores the verification results of receive packet No.2. Element No. where the verification result did not match (b0 to b7) The cause of mismatch (verification result code) (b8 to b15)	R
SD10884	Connection No.8 received data verification result (receive packet No.3)	Stores the verification results of receive packet No.3. Element No. where the verification result did not match (b0 to b7) The cause of mismatch (verification result code) (b8 to b15)	R
SD10885	Connection No.8 received data verification result (receive packet No.4)	Stores the verification results of receive packet No.4. Element No. where the verification result did not match (b0 to b7) The cause of mismatch (verification result code) (b8 to b15)	R
SD10886	Connection No.8 received data verification result (receive packet No.5)	Stores the verification results of receive packet No.5. Element No. where the verification result did not match (b0 to b7) The cause of mismatch (verification result code) (b8 to b15)	R
SD10887	Connection No.8 received data verification result (receive packet No.6)	Stores the verification results of receive packet No.6. Element No. where the verification result did not match (b0 to b7) The cause of mismatch (verification result code) (b8 to b15)	R
SD10888	Connection No.8 received data verification result (receive packet No.7)	Stores the verification results of receive packet No.7. Element No. where the verification result did not match (b0 to b7) The cause of mismatch (verification result code) (b8 to b15)	R

Device No.	Name	Description	R/W
SD10889	Connection No.8 received data verification result (receive packet No.8)	Stores the verification results of receive packet No.8. Element No. where the verification result did not match (b0 to b7) The cause of mismatch (verification result code) (b8 to b15)	R
SD10890	Connection No.8 received data verification result (receive packet No.9)	Stores the verification results of receive packet No.9. Element No. where the verification result did not match (b0 to b7) The cause of mismatch (verification result code) (b8 to b15)	R
SD10891	Connection No.8 received data verification result (receive packet No.10)	Stores the verification results of receive packet No.10. Element No. where the verification result did not match (b0 to b7) The cause of mismatch (verification result code) (b8 to b15)	R
SD10892	Connection No.8 received data verification result (receive packet No.11)	Stores the verification results of receive packet No.11. Element No. where the verification result did not match (b0 to b7) The cause of mismatch (verification result code) (b8 to b15)	R
SD10893	Connection No.8 received data verification result (receive packet No.12)	Stores the verification results of receive packet No.12. Element No. where the verification result did not match (b0 to b7) The cause of mismatch (verification result code) (b8 to b15)	R
SD10894	Connection No.8 received data verification result (receive packet No.13)	Stores the verification results of receive packet No.13. Element No. where the verification result did not match (b0 to b7) The cause of mismatch (verification result code) (b8 to b15)	R
SD10895	Connection No.8 received data verification result (receive packet No.14)	Stores the verification results of receive packet No.14. Element No. where the verification result did not match (b0 to b7) The cause of mismatch (verification result code) (b8 to b15)	R
SD10896	Connection No.8 received data verification result (receive packet No.15)	Stores the verification results of receive packet No.15. Element No. where the verification result did not match (b0 to b7) The cause of mismatch (verification result code) (b8 to b15)	R
SD10897	Connection No.8 received data verification result (receive packet No.16)	Stores the verification results of receive packet No.16. Element No. where the verification result did not match (b0 to b7) The cause of mismatch (verification result code) (b8 to b15)	R
SD10898	Connection No.8 protocol execution count	Stores the number of protocol executions in connection No.8. 0: Protocol not executed 1 to 65535: Number of executions	R
SD10899	Connection No.8 protocol cancellation specification	Cancels the protocol executed in connection No.8. 0: No cancellation instruction 1: Cancellation request (set by user) 2: Cancellation completed (set by system)	R/W

R: Read only, R/W: Read/Write

- *1 The setting value may be unidentifiable (65535) in the following cases.
- When a setting that cannot be detected by the current CPU module version is written
 - When protocol setting data is broken (hardware failure)

INDEX

A

Active open 65

E

Engineering tool 10

External device 10

F

Fullpassive 65

I

Intelligent function module 9

L

Lock processing 94

P

Passive open 65

S

SLMP 10

T

TCP. 13

U

UDP 13

Unlock processing 94

Unpassive 65



REVISIONS

Revision date	Revision	Description
October 2014	A	First Edition
January 2015	B	■Added functions Data code of ASCII to SLMP, Predefined protocol support function, Ethernet diagnostics ■Added or modified parts RELEVANT MANUALS, TERMS, Chapter 1, 2, 3, Section 4.1, Chapter 5, 6, Section 7.2, 7.3, 7.4, 10.1, 10.2, Appendix 1
April 2015	C	A part of the cover design is changed.
May 2016	D	Errors are corrected.

This manual confers no industrial property rights or any rights of any other kind, nor does it confer any patent licenses. Mitsubishi Electric Corporation cannot be held responsible for any problems involving industrial property rights which may occur as a result of using the contents noted in this manual.

© 2014 MITSUBISHI ELECTRIC CORPORATION

WARRANTY

Please confirm the following product warranty details before using this product.

1. Gratis Warranty Term and Gratis Warranty Range

If any faults or defects (hereinafter "Failure") found to be the responsibility of Mitsubishi occurs during use of the product within the gratis warranty term, the product shall be repaired at no cost via the sales representative or Mitsubishi Service Company. However, if repairs are required onsite at domestic or overseas location, expenses to send an engineer will be solely at the customer's discretion. Mitsubishi shall not be held responsible for any re-commissioning, maintenance, or testing on-site that involves replacement of the failed module.

[Gratis Warranty Term]

The gratis warranty term of the product shall be for one year after the date of purchase or delivery to a designated place. Note that after manufacture and shipment from Mitsubishi, the maximum distribution period shall be six (6) months, and the longest gratis warranty term after manufacturing shall be eighteen (18) months. The gratis warranty term of repair parts shall not exceed the gratis warranty term before repairs.

[Gratis Warranty Range]

- (1) The range shall be limited to normal use within the usage state, usage methods and usage environment, etc., which follow the conditions and precautions, etc., given in the instruction manual, user's manual and caution labels on the product.
- (2) Even within the gratis warranty term, repairs shall be charged for in the following cases.
 1. Failure occurring from inappropriate storage or handling, carelessness or negligence by the user. Failure caused by the user's hardware or software design.
 2. Failure caused by unapproved modifications, etc., to the product by the user.
 3. When the Mitsubishi product is assembled into a user's device, Failure that could have been avoided if functions or structures, judged as necessary in the legal safety measures the user's device is subject to or as necessary by industry standards, had been provided.
 4. Failure that could have been avoided if consumable parts (battery, backlight, fuse, etc.) designated in the instruction manual had been correctly serviced or replaced.
 5. Relay failure or output contact failure caused by usage beyond the specified life of contact (cycles).
 6. Failure caused by external irresistible forces such as fires or abnormal voltages, and failure caused by force majeure such as earthquakes, lightning, wind and water damage.
 7. Failure caused by reasons unpredictable by scientific technology standards at time of shipment from Mitsubishi.
 8. Any other failure found not to be the responsibility of Mitsubishi or that admitted not to be so by the user.

2. Onerous repair term after discontinuation of production

- (1) Mitsubishi shall accept onerous product repairs for seven (7) years after production of the product is discontinued.
Discontinuation of production shall be notified with Mitsubishi Technical Bulletins, etc.
- (2) Product supply (including repair parts) is not available after production is discontinued.

3. Overseas service

Overseas, repairs shall be accepted by Mitsubishi's local overseas FA Center. Note that the repair conditions at each FA Center may differ.

4. Exclusion of loss in opportunity and secondary loss from warranty liability

Regardless of the gratis warranty term, Mitsubishi shall not be liable for compensation to:

- (1) Damages caused by any cause found not to be the responsibility of Mitsubishi.
- (2) Loss in opportunity, lost profits incurred to the user by Failures of Mitsubishi products.
- (3) Special damages and secondary damages whether foreseeable or not, compensation for accidents, and compensation for damages to products other than Mitsubishi products.
- (4) Replacement by the user, maintenance of on-site equipment, start-up test run and other tasks.

5. Changes in product specifications

The specifications given in the catalogs, manuals or technical documents are subject to change without prior notice.

6. Product application

- (1) In using the Mitsubishi MELSEC programmable controller, the usage conditions shall be that the application will not lead to a major accident even if any problem or fault should occur in the programmable controller device, and that backup and fail-safe functions are systematically provided outside of the device for any problem or fault.
- (2) The Mitsubishi programmable controller has been designed and manufactured for applications in general industries, etc. Thus, applications in which the public could be affected such as in nuclear power plants and other power plants operated by respective power companies, and applications in which a special quality assurance system is required, such as for railway companies or public service purposes shall be excluded from the programmable controller applications.
In addition, applications in which human life or property that could be greatly affected, such as in aircraft, medical applications, incineration and fuel devices, manned transportation, equipment for recreation and amusement, and safety devices, shall also be excluded from the programmable controller range of applications.
However, in certain cases, some applications may be possible, providing the user consults their local Mitsubishi representative outlining the special requirements of the project, and providing that all parties concerned agree to the special circumstances, solely at the user's discretion.

TRADEMARKS

Microsoft® and Windows® are either registered trademarks or trademarks of Microsoft Corporation in the United States and/or other countries.

Ethernet is a trademark of Xerox Corporation.

MODBUS® is a registered trademark of Schneider Electric SA.

The company name and the product name to be described in this manual are the registered trademarks or trademarks of each company.

Manual number: JY997D56201D

Model: FX5-U-EN-E

Model code: 09R543

When exported from Japan, this manual does not require application to the Ministry of Economy, Trade and Industry for service transaction permission.

MITSUBISHI ELECTRIC CORPORATION

HEAD OFFICE: TOKYO BUILDING, 2-7-3 MARUNOUCHI, CHIYODA-KU, TOKYO 100-8310, JAPAN

Specifications are subject to change without notice.