

Industrial automation

Elincom Group

 European Union: www.elinco.eu

 Russia: www.elinc.ru

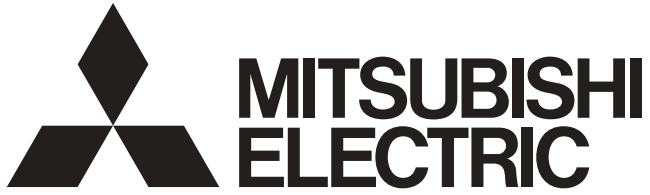

PROGRAMMABLE CONTROLLERS

MELSEC iQ-F
series

MELSEC iQ-F

FX5 Programming Manual (Program Design)

SAFETY PRECAUTIONS

(Read these precautions before using this product.)

Before using the FX5 PLCs, please read the manual supplied with each product and the relevant manuals introduced in that manual carefully and pay full attention to safety to handle the product correctly.

Store this manual in a safe place so that it can be taken out and read whenever necessary. Always forward it to the end user.

INTRODUCTION

This manual describes the instructions and functions required for programming of the FX5. Please read this manual and the relevant manuals and understand the functions and performance of the FX5 PLCs before attempting to use the unit.

It should be read and understood before attempting to install or use the unit. Store this manual in a safe place so that you can take it out and read it whenever necessary. Always forward it to the end user.

When utilizing the program examples introduced in this manual to the actual system, always confirm that it poses no problem for control of the target system.

Regarding use of this product

- This product has been manufactured as a general-purpose part for general industries, and has not been designed or manufactured to be incorporated in a device or system used in purposes related to human life.
- Before using the product for special purposes such as nuclear power, electric power, aerospace, medicine or passenger movement vehicles, consult with Mitsubishi Electric.
- This product has been manufactured under strict quality control. However when installing the product where major accidents or losses could occur if the product fails, install appropriate backup or failsafe functions in the system.

Note

- If in doubt at any stage during the installation of the product, always consult a professional electrical engineer who is qualified and trained to the local and national standards. If in doubt about the operation or use, please consult the nearest Mitsubishi Electric representative.
- Since the examples indicated by this manual, technical bulletin, catalog, etc. are used as a reference, please use it after confirming the function and safety of the equipment and system. Mitsubishi Electric will accept no responsibility for actual use of the product based on these illustrative examples.
- This manual content, specification etc. may be changed without a notice for improvement.
- The information in this manual has been carefully checked and is believed to be accurate; however, if you have noticed a doubtful point, a doubtful error, etc., please contact the nearest Mitsubishi Electric representative. When doing so, please provide the manual number given at the end of this manual.

CONTENTS

SAFETY PRECAUTIONS	1
INTRODUCTION	1
RELEVANT MANUALS	4
TERMS	5
CHAPTER 1 OUTLINE	7
CHAPTER 2 PROGRAM CONFIGURATION	9
2.1 Program Block	10
CHAPTER 3 PROGRAM ORGANIZATION UNIT (POU)	11
3.1 Function (FUN)	12
3.2 Function Block (FB)	16
CHAPTER 4 LABELS	22
4.1 Type	22
4.2 Class	23
4.3 Data Type	23
4.4 Arrays	26
4.5 Structures	28
4.6 Constant	30
4.7 Precautions	31
CHAPTER 5 LADDER DIAGRAM	33
5.1 Configuration	33
Ladder symbols	33
Program execution order	34
5.2 Inline ST	35
5.3 Statements and Notes	36
CHAPTER 6 ST LANGUAGE	37
6.1 Configuration	38
Delimiter	39
Operator	39
Syntax	40
Constant	47
Label and device	47
Comment	48
CHAPTER 7 FBD/LD language	49
7.1 Configuration	49
Program unit	50
Worksheet	54
Constant	54
Labels and devices	54
7.2 Program execution order	55
The order of executions of program units	55

INDEX

56

REVISIONS58
WARRANTY59
TRADEMARKS60

RELEVANT MANUALS

User's manuals for the applicable modules

Manual name <manual number>	Description
MELSEC iQ-F FX5 User's Manual (Startup) <JY997D58201>	Performance specifications, procedures before operation, and troubleshooting of the CPU module.
MELSEC iQ-F FX5U User's Manual (Hardware) <JY997D55301>	Describes the details of hardware of the FX5U CPU module, including input/output specifications, wiring, installation, and maintenance.
MELSEC iQ-F FX5UC User's Manual (Hardware) <JY997D61401>	Describes the details of hardware of the FX5UC CPU module, including input/output specifications, wiring, installation, and maintenance.
MELSEC iQ-F FX5 User's Manual (Application) <JY997D55401>	Describes basic knowledge required for program design, functions of the CPU module, devices/labels, and parameters.
MELSEC iQ-F FX5 Programming Manual (Program Design) <JY997D55701> (This manual)	Describes specifications of ladders, ST, FBD/LD, and other programs and labels.
MELSEC iQ-F FX5 Programming Manual (Instructions, Standard Functions/Function Blocks) <JY997D55801>	Describes specifications of instructions and functions that can be used in programs.
MELSEC iQ-F FX5 User's Manual (Serial Communication) <JY997D55901>	Describes N:N network, MELSEC Communication protocol, inverter communication, non-protocol communication, and predefined protocol support.
MELSEC iQ-F FX5 User's Manual (MODBUS Communication) <JY997D56101>	Describes MODBUS serial communication.
MELSEC iQ-F FX5 User's Manual (Ethernet Communication) <JY997D56201>	Describes the functions of the built-in Ethernet port communication function.
MELSEC iQ-F FX5 User's Manual (SLMP) <JY997D56001>	Explains methods for the device that is communicating with the CPU module by SLMP to read and write the data of the CPU module.
MELSEC iQ-F FX5 User's Manual (Positioning Control) <JY997D56301>	Describes the built-in positioning function.
MELSEC iQ-F FX5 User's Manual (Analog Control) <JY997D60501>	Describes the analog function.
GX Works3 Operating Manual <SH-081215ENG>	System configuration, parameter settings, and online operations of GX Works3.

TERMS

Unless otherwise specified, this manual uses the following terms.

- □ indicates a variable part to collectively call multiple models or versions.
(Example) FX5U-32MR/ES, FX5U-32MT/ES ⇨ FX5U-32M□/ES
- For details on the FX3 devices that can be connected with the FX5, refer to FX5 User's Manual (Hardware).

Terms	Description
■Devices	
FX5	Abbreviation of FX5 PLCs
FX3	Generic term for FX3S, FX3G, FX3GC, FX3U, and FX3UC PLCs
FX5 CPU module	Generic term for FX5U CPU module and FX5UC CPU module
FX5U CPU module	Generic term for FX5U-32MR/ES, FX5U-32MT/ES, FX5U-32MT/ESS, FX5U-64MR/ES, FX5U-64MT/ES, FX5U-64MT/ESS, FX5U-80MR/ES, FX5U-80MT/ES, and FX5U-80MT/ESS
FX5UC CPU module	Generic term for FX5UC-32MT/D and FX5UC-32MT/DSS
Extension module	Generic term for FX5 extension modules and FX3 function modules
• FX5 extension module	Generic term for I/O modules, FX5 extension power supply module, and FX5 intelligent function module
• FX3 extension module	Generic term for FX3 extension power supply module and FX3 special function blocks
Extension module (extension cable type)	Input modules (extension cable type), Output modules (extension cable type), Bus conversion module (extension cable type), and Intelligent function modules
Extension module (extension connector type)	Input modules (extension connector type), Output modules (extension connector type), Input/output modules, Bus conversion module (extension connector type), and Connector conversion module (extension connector type)
I/O module	Generic term for input modules, output modules, Input/output modules, and powered input/output modules
Input module	Generic term for Input modules (extension cable type) and Input modules (extension connector type)
• Input module (extension cable type)	Generic term for FX5-8EX/ES and FX5-16EX/ES
• Input module (extension connector type)	Generic term for FX5-C32EX/D and FX5-C32EX/DS
Output module	Generic term for output modules (extension cable type) and output modules (extension connector type)
• Output module (extension cable type)	Generic term for FX5-8EYR/ES, FX5-8EYT/ES, FX5-8EYT/ESS, FX5-16EYR/ES, FX5-16EYT/ES, and FX5-16EYT/ESS
• Output module (extension connector type)	Generic term for FX5-C32EYT/D and FX5-C32EYT/DSS
Input/output modules	Generic term for FX5-C32ET/D and FX5-C32ET/DSS
Powered input/output module	Generic term for FX5-32ER/ES, FX5-32ET/ES, and FX5-32ET/ESS
Extension power supply module	Generic term for FX5 extension power supply module and FX3 extension power supply module
• FX5 extension power supply module	Different name for FX5-1PSU-5V
• FX3 extension power supply module	Different name for FX3U-1PSU-5V
Intelligent module	The abbreviation for intelligent function modules
Intelligent function module	Generic term for FX5 intelligent function modules and FX3 intelligent function modules
• FX5 intelligent function module	Generic term for FX5 intelligent function modules
• FX3 intelligent function module	Generic term for FX3 special function blocks
Simple motion module	Different name for FX5-40SSC-S
Expansion board	Generic term for board for FX5U CPU module
• Communication board	Generic term for FX5-232-BD, FX5-485-BD, and FX5-422-BD-GOT
Expansion adapter	Generic term for adapter for FX5 CPU module
• Communication adapter	Generic term for FX5-232ADP and FX5-485ADP
• Analog adapter	Generic term for FX5-4AD-ADP and FX5-4DA-ADP
Bus conversion module	Generic term for Bus conversion module (extension cable type) and Bus conversion module (extension connector type)
• Bus conversion module (extension cable type)	Different name for FX5-CNV-BUS
• Bus conversion module (extension connector type)	Different name for FX5-CNV-BUSC
Battery	Different name for FX3U-32BL
Peripheral device	Generic term for engineering tools and GOTs
GOT	Generic term for Mitsubishi Graphic Operation Terminal GOT1000 and GOT2000 series

Terms	Description
■Software packages	
Engineering tool	The product name of the software package for the MELSEC programmable controllers
GX Works3	The product name of the software package, SWnDND-GXW3, for the MELSEC programmable controllers (The 'n' represents a version.)
■Manuals	
User's manual	Generic term for separate manuals
• User's manual (Startup)	Abbreviation of MELSEC iQ-F FX5 User's Manual (Startup)
• FX5 User's manual (Hardware)	Generic term for MELSEC iQ-F FX5U User's Manual (Hardware) and MELSEC iQ-F FX5UC User's Manual (Hardware)
• FX5U User's manual (Hardware)	Abbreviation of MELSEC iQ-F FX5U User's Manual (Hardware)
• FX5UC User's manual (Hardware)	Abbreviation of MELSEC iQ-F FX5UC User's Manual (Hardware)
• User's manual (Application)	Abbreviation of MELSEC iQ-F FX5 User's Manual (Application)
Programming manual (Program Design)	Abbreviation of MELSEC iQ-F FX5 Programming Manual (Program Design)
Programming manual (Instructions, Standard Functions/Function Blocks)	Abbreviation of MELSEC iQ-F FX5 Programming Manual (Instructions, Standard Functions/Function Blocks)
Communication manual	Generic term for MELSEC iQ-F FX5 User's Manual (Serial Communication), MELSEC iQ-F FX5 User's Manual (MODBUS Communication), MELSEC iQ-F FX5 User's Manual (Ethernet Communication), and MELSEC iQ-F FX5 User's Manual (SLMP)
• Serial communication manual	Abbreviation of MELSEC iQ-F FX5 User's Manual (Serial Communication)
• MODBUS communication manual	Abbreviation of MELSEC iQ-F FX5 User's Manual (MODBUS Communication)
• Ethernet communication manual	Abbreviation of MELSEC iQ-F FX5 User's Manual (Ethernet Communication)
• SLMP manual	Abbreviation of MELSEC iQ-F FX5 User's Manual (SLMP)
Positioning manual	Abbreviation of MELSEC iQ-F FX5 User's Manual (Positioning Control)
Analog manual	Abbreviation of MELSEC iQ-F FX5 User's Manual (Analog Control)
■Program	
Operand	A generic term for items, such as source data (s), destination data (d), number of devices (n), and others, used to configure instructions and functions
Device	A device (X, Y, M, D, or others) in a CPU module
Buffer memory	A memory in an intelligent function module, where data (such as setting values and monitoring values) are stored.
POU	Defined unit of a program. Use of POU enables a program to be divided into units according to process or function, and each unit to be programmed individually.

1 OUTLINE

This manual describes program configurations, content, and method for creating programs.
 For how to create, edit, or monitor programs using the engineering tool, refer to the following.

GX Works3 Operating Manual

Type of programming languages

With the FX5 series, the optimal programming language can be selected according to the application.

Programming language	Description
Ladder diagram	Ladder diagram is a graphic language that indicates circuits using contacts, coils, and others. The ladder diagram describes logic circuits with symbolized contacts and coils for easy-to-understand sequence control.
Structured text language (ST language)	ST language is a text language that describes programs with IF statements, operators, and others. Because operation processing that is difficult to describe in ladder diagram can be easily and briefly described with ST language, ST language is suitable for applications requiring complicated arithmetic operation or comparative operation. With ST language, programs can be easily described with syntax using selective branches with conditional statements and repetition by repetitive statements in the same way as C language.
Function block diagram/ladder diagram (FBD/LD language)	This is a graphic language that describes a program by wiring blocks for specific processing (function elements, FB elements), variable elements, and constant elements along with the flows of data and signals. You can easily create a program that may be complicated to create by using a ladder program. So you can enhance the productivity of programs.

■Ladder diagram

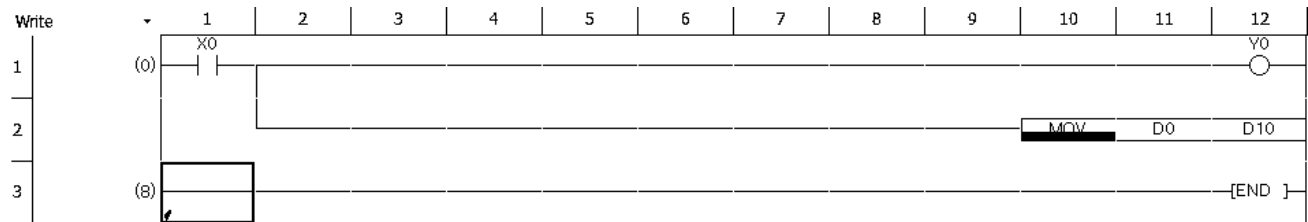

When using ladder diagram, refer to the following.

Page 33 LADDER DIAGRAM

■ST language

```

1 IF X0 THEN
2     YO := TRUE ;
3     DO := D10 ;
4 END_IF ;
5

```

When using ST language, refer to the following.

Page 37 ST LANGUAGE

■FBD/LD language

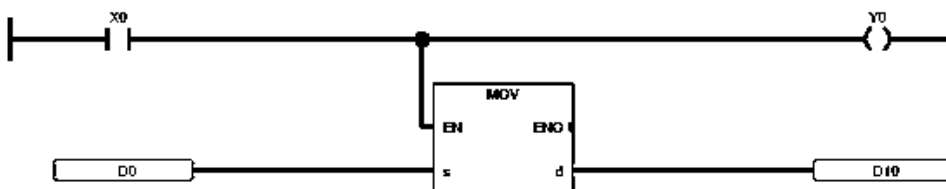

When using FBD/LD language, refer to the following.

Page 49 FBD/LD language

Point 

-
- Ladder diagram and FBD/LD language are for customers who have knowledge or experience of sequence control and logic circuits.
 - ST language is for customers who have knowledge or experience of the C language programming.
 - By using labels in a program, the readability of the program is improved, and activating a program for the system with a different module configuration is easy.
-

2 PROGRAM CONFIGURATION

Using the engineering tool, multiple programs and POUs (Program Organization Units) can be created. Thus, programs and POUs can be sorted by processing. This chapter describes the program configuration.

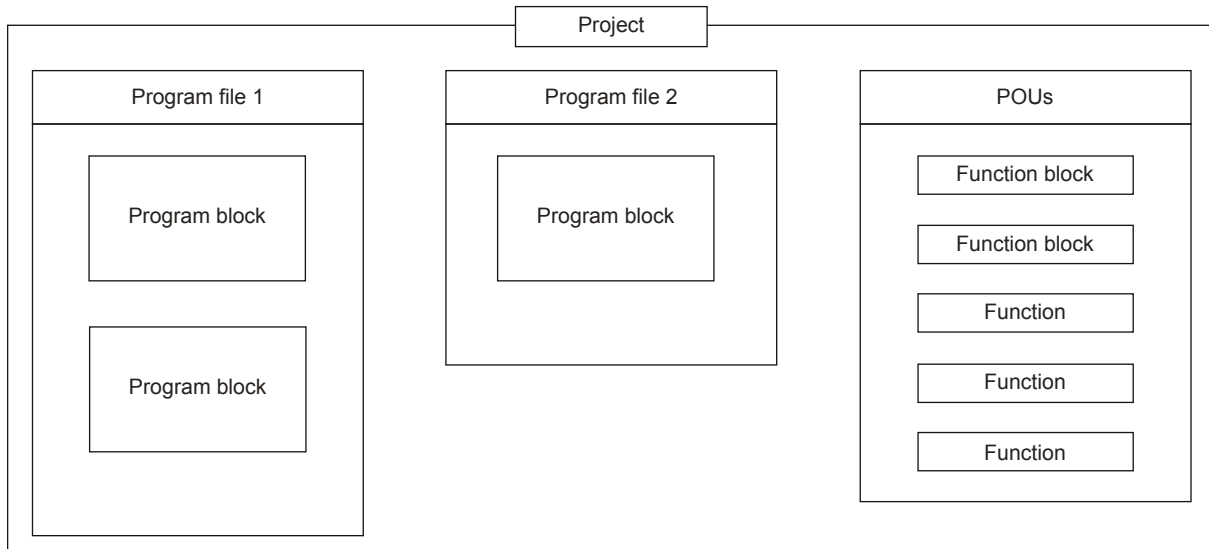

For the POU, refer to the following.

📖 Page 11 PROGRAM ORGANIZATION UNIT (POU)

Project

A project is a collection of data (including programs and parameters) to be executed by the CPU module. Only one project can be written to one CPU module. For one project, one or more program files need to be created.

Program file

A program file is a collection of programs and POUs. One program file consists of one or more program blocks. The operation on the program file level can be changed, such as, the execution type of a program can be switched from scan execution type to standby type, or whether to write data to the CPU module.

2.1 Program Block

A program block is a unit of a program.

Multiple program blocks can be created in one program file, and are executed in the registered order.

By dividing program blocks by functions or processing, changing the program order or replacing the program becomes easy.

Program blocks are stored in program files of each program in the registration destination.

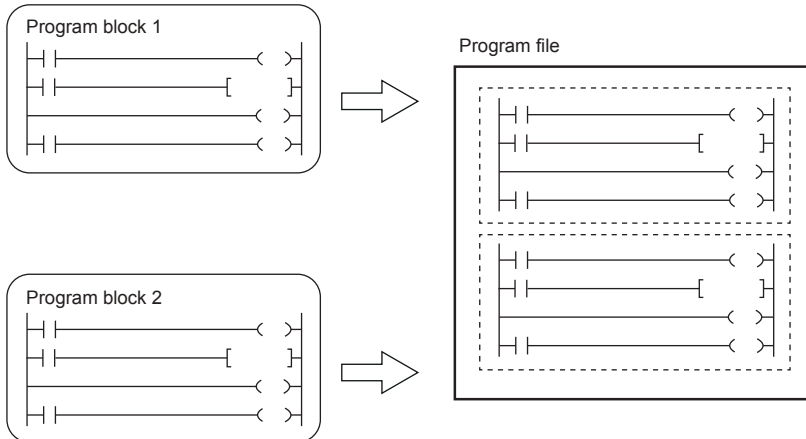

Creating main routine programs, subroutine programs, and interrupt programs for each program block makes the program easy to read.

Type	Description
Main routine program	Program segment from the step 0 to the FEND instruction
Subroutine program	Program segment from a pointer (P) to the RET instruction Executed only when a subroutine call instruction (CALL instruction etc.) is executed.
Interrupt program	Program segment from an interrupt pointer (I) to the IRET instruction When an interrupt is triggered, the interrupt program corresponding to the interrupt pointer number is executed.

For details on the main routine program, subroutine program, and interrupt program, refer to the following.

📖 User's manual (Application)

- Create subroutine programs and interrupt programs after the FEND instruction. The program area after the FEND instruction is not executed as the main routine program. For example, when the FEND instruction is used at the end of the second program block, the third program block and later are handled as subroutine programs or interrupt programs.
- To make the program easy to read, use twin instructions, such as FOR and NEXT instructions and MC and MCR instructions, in the same program block.
- A simple program can be executed by the CPU module with just a main routine program in one program block.

3 PROGRAM ORGANIZATION UNIT (POU)

The POU includes the following types.

- Function
- Function block

The processing of each POU can be described in a programming language according to the control. POU's are called from a program block, and then executed.

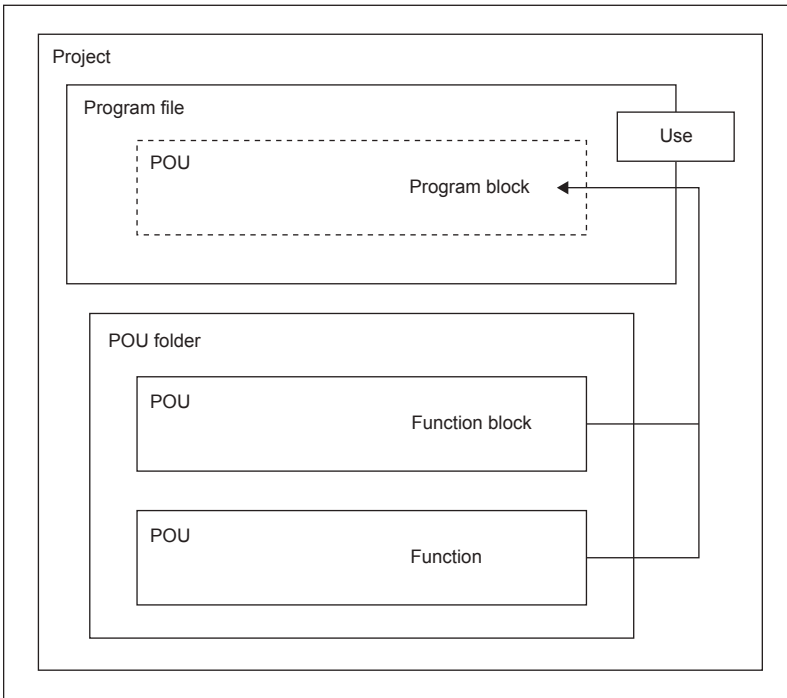

Point 🔍

A structured program is a program created by components. Processes in lower levels of hierarchical program are divided to several components according to their processing information and functions. Each component is designed to have a high degree of independence for easy addition and replacement. The following shows examples of the process that would be ideal to be structured.

- A process that is used repeatedly in a program
- A process that can be divided into functions

This chapter describes two types of POU's using labels.

Devices can also be used in the program of a function or function block. For details on devices, refer to the following.

📖 User's manual (Application)

3.1 Function (FUN)

Functions are a type of POU used by program blocks, function blocks, or other functions.

The function sends back a value to the call source after execution. The value is called return values.

The function always outputs the same return value as the processing result in response to the same input.

The function can be re-used effectively by defining a simple, independent, and frequently used algorithm.

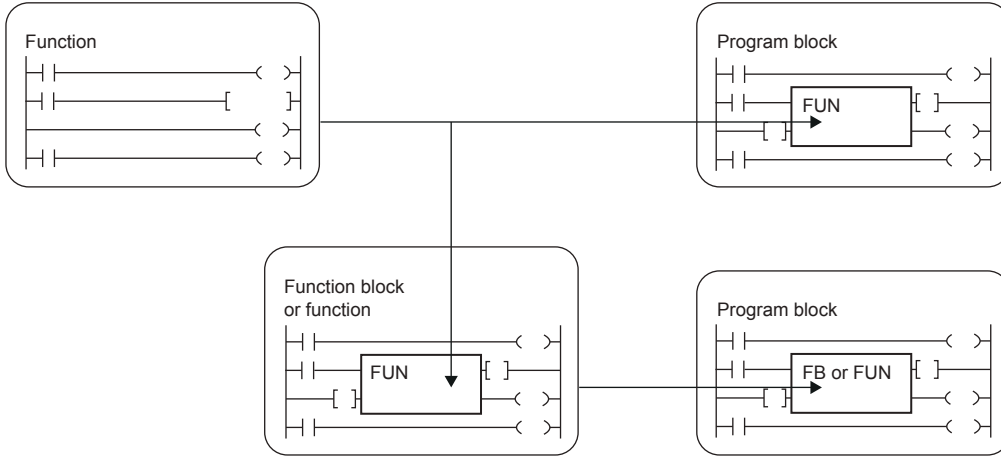

Input variable and output variable

For a function, input variables and output variables can be defined. Output variable can be created to output data separate from the return value.

■ Case of ladder diagram

■ Case of FBD/LD language

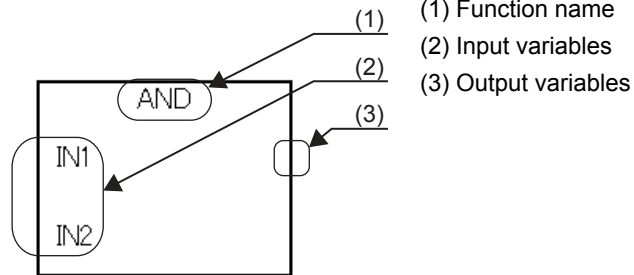
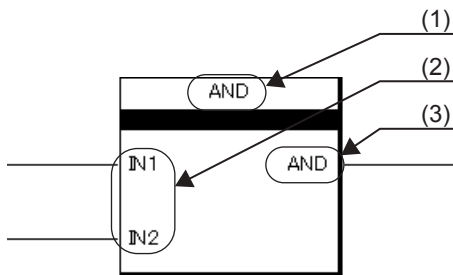

- (1) Function name
- (2) Input variables
- (3) Output variables

For classes for which input variables or output variables can be set, refer to the following.

📖 Page 23 Class

Point

Variables defined in a function are overwritten every time the function is called.

To retain the variable values at each call, use a function block or design a program so that an output variable is saved in a different variable.

EN/ENO

An EN (enable input) and ENO (enable output) can be appended to a function to control its execution.

- A Boolean variable used as an executing condition of a function is set to an EN.
- A function with an EN is executed only when the executing condition of the EN is TRUE.
- A Boolean variable used as an output of function execution result is set to an ENO.

For the Boolean variable, refer to the following.

 Page 23 Data Type

The table below shows the "ENO" status corresponding to the "EN" status and the operation result.

EN	ENO	Operation result
TRUE (Executes operation)	TRUE	Operation output value
FALSE (Stops operation)	FALSE	Indefinite value

Point

- Setting an output label to an ENO is not required.
- When an EN or ENO is used for standard functions, functions with an EN are shown as "Function name_E".

Creating programs

The program of a function can be created by using the engineering tool.



 Navigation window ⇒ "FB/FUN" ⇒ Right-click ⇒ "Add New Data"

The created program is stored in the FB/FUN file.

 [CPU Parameter] ⇒ "Program Setting" ⇒ "FB/FUN File Setting"

Up to 64 programs can be stored in one FB/FUN file.

For details on program creation, refer to the following.

Item	Reference
How to create function programs	 GX Works3 Operating Manual
Number of FB/FUN files that can be written to a CPU module	 User's manual (Startup)

■Applicable devices and labels

The following table lists the devices and labels that can be used in function programs.

○: Applicable, △: Applicable only by instructions (Not applicable as a label indicating a program step), ×: Not applicable

Type of device/label		Availability
Label (other than pointer type)	Global label	×
	Local label	○*1
Label (pointer type)	Pointer type global label	△
	Pointer type local label	○
Device	Global device	○
Pointer	Global pointer	△

*1 The timer, retentive timer, counter and long counter types cannot be used.

Operation overview

The program of a function is stored in the FB/FUN file and called by the calling source program when executed

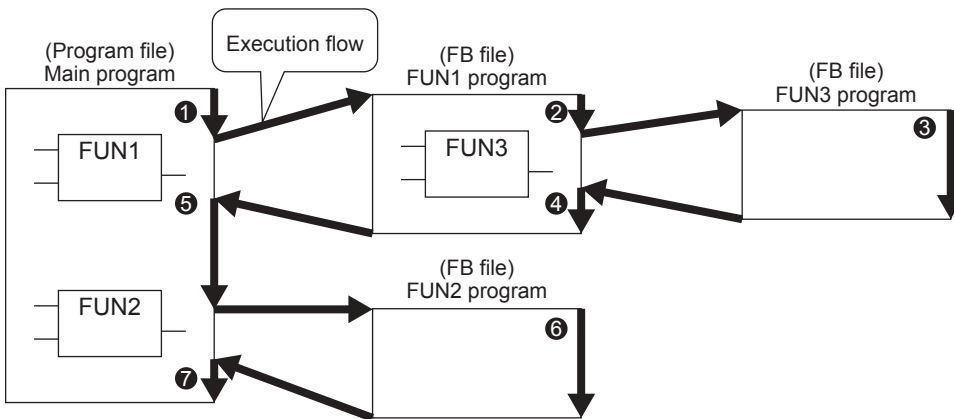

You can nest all function blocks and functions up to 32 times.

Labels defined by a function

The labels defined by a function are assigned in the temporary areas of the storage-target memory during execution of the function, and the areas are freed after the processing completes.

The following figure shows the label assignments while the above functions are being executed.

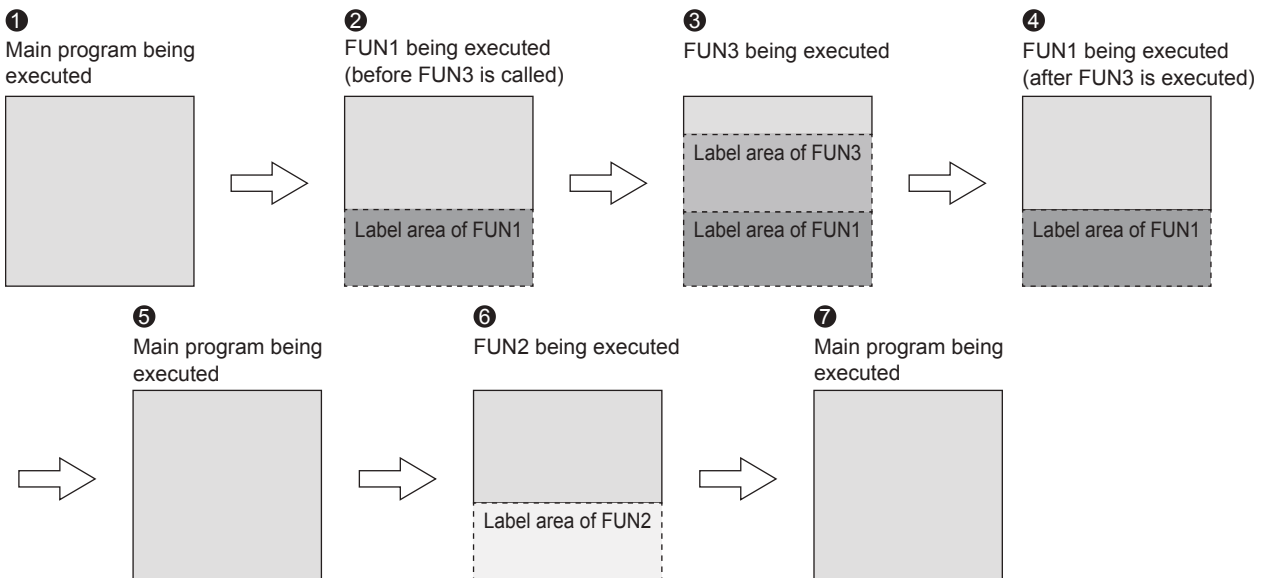

For the types of labels that can be defined by a function, refer to the following.

📖 Page 23 Class

Point

The label to be defined by a function must be initialized by a program before the first access because the label value will be undefined.

Number of steps

To call a function, the number of steps required is not only for the program itself but also for the processing that passes the argument and return value, the processing that calls the program, and additional steps used by the system.

■ Program

The number of steps required for a function program is the total number of instruction steps plus at least additional 13 steps used by the system. For the number of steps required for each instruction, refer to the following.

📖 Programming manual (Instructions, Standard Functions/Function Blocks)

■ Calling source

When calling a function, the calling source generates the processing that passes the argument and return value before and after the call processing.

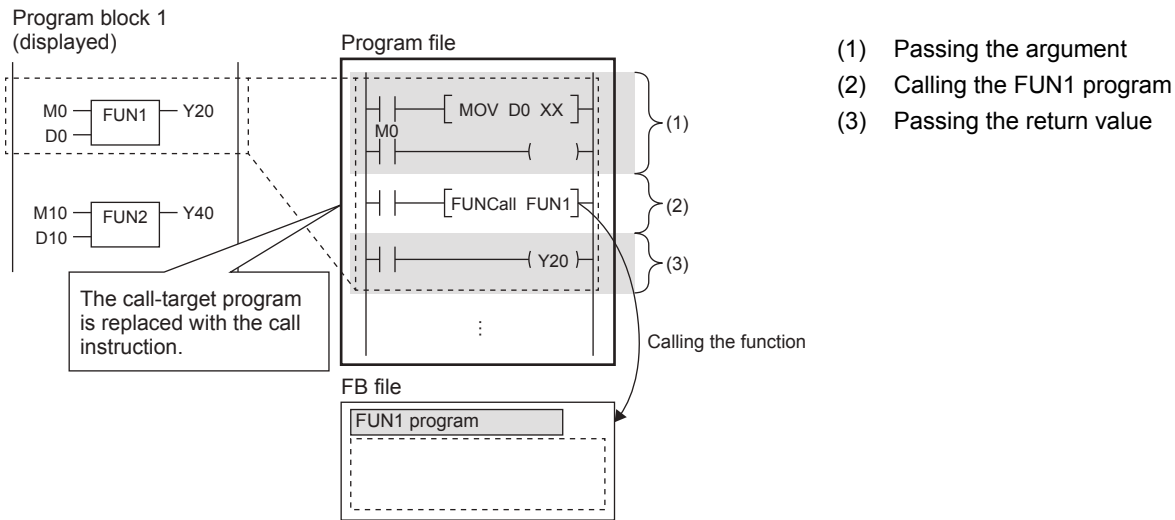

Passing the argument

The instruction used to pass the argument differs depending on the class and data type of the argument. The following table summarizes the instructions that can be used to pass the argument.

Argument class	Data type	Instruction used	Number of steps
VAR_INPUT	Bit	LD+OUT LD+MOVB (Which of the above instructions is used is determined by the combination of the programming language, type of function, and type of input argument.)	For the number of steps required for each instruction, refer to the following. Programming manual (Instructions, Standard Functions/Function Blocks)
	Word [Unsigned]/Bit String [16-bit]	LD+MOV	
	Double Word [Unsigned]/Bit String [32-bit]	LD+DMOV	
	Word [Signed]		
	Double Word [Signed]		
	FLOAT [Single Precision]	LD+EMOV	
	Time	LD+DMOV	
	String(32)	LD+\$MOV	
	Array, Structure	LD+BMOV	

Calling the program

At least 16 steps are required to call the program of a function.

Passing the return value

The instruction and the number of steps used for passing the return value are identical to those for passing the argument.

Argument class	Data type	Instruction used	Number of steps
VAR_OUTPUT	Same as for passing the argument	Same as for passing the argument	Same as for passing the argument

EN/ENO

The following table lists the number of steps required for EN/ENO.

Item	Number of steps
EN	6
ENO	4

Precautions

■ Global pointer/local pointer/pointer type global labels

Global pointer, local pointer, and pointer type global labels cannot be used as labels indicating program steps in the function program.

3.2 Function Block (FB)

Function blocks are a type of POU used by program blocks or other function blocks.

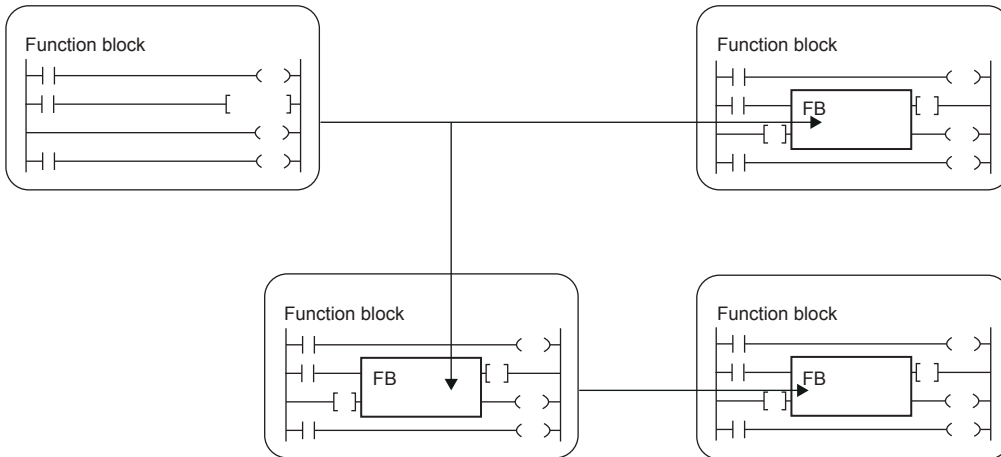

Unlike the function, the function block does not output return values.

The function block can save a value in a variable, and thus the input status and processing result are retained.

Because the retained value is used for the next processing, the same result is not always output even with the same input value.

■ Case of ladder diagram

■ Case of FBD/LD language

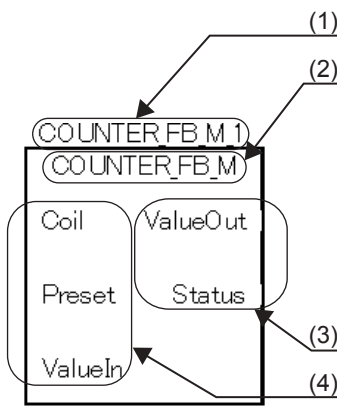
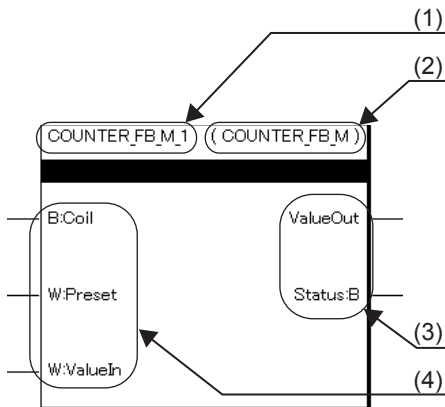

- (1) Instance name
- (2) Function block name
- (3) Output variables
- (4) Input variables

To use the function block in a program, instances must be defined.

☞ Page 17 Instances

Input variable, output variable, and input/output variable

Input variables, output variables, and input/output variables must be defined for function blocks.

The function block can output multiple operation results and can also be created without any output.

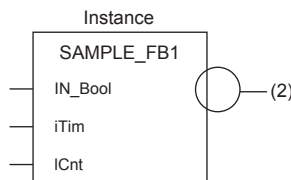
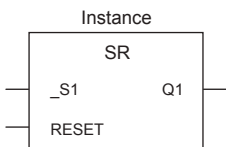

- (1) Multiple outputs are returned.
- (2) No outputs are returned.

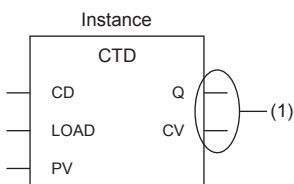

For classes for which input variables, output variables, or input/output variables can be set, refer to the following.

☞ Page 23 Class

Internal variable

For the function block, internal variables can be used.
 For classes for which internal variables can be set, refer to the following.
 Page 23 Class

External variable

For the function block, external variables can be used.
 For classes for which external variables can be set, refer to the following.
 Page 23 Class

Instances

Instances

To use the function block, instances must be created.
 By creating instances of the function block, the function block can be used by calling from a program or another function block. Multiple instances can be created from one function block definition.
 To create an instance, define it as a global label or local label of the POU that uses the function block. The instance can be defined as an array.
 The same function block can be used in different instances in one POU. For each instance of a function block, labels are assigned to different areas in memory. Even though the same label names are used, different states are held for each instance.

Ex.

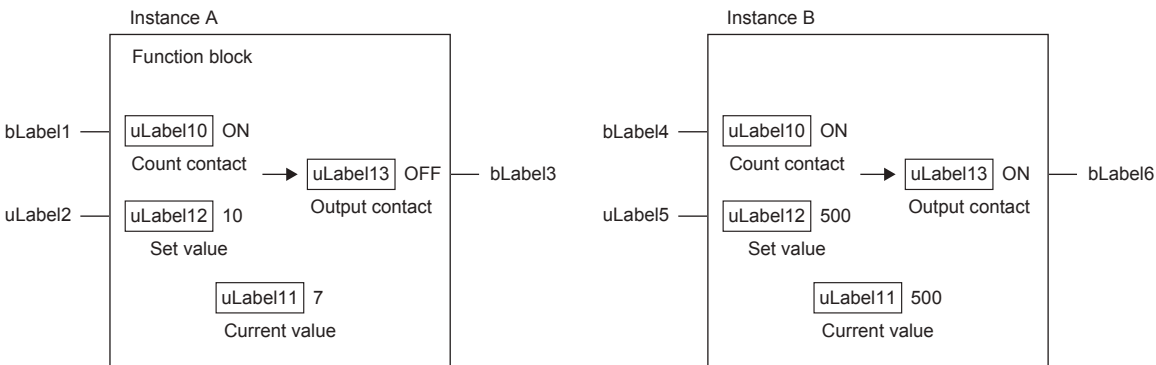

The above function block starts counting current value when the input variables (Count contact) turn on and turns on the output variable (Output contact) when the current value held in the internal variable reaches the set value.
 Instance A and B are the same function blocks, but instances A and B hold different states because the instance is different. In the above example, output variable (Output contact) of instance B is already turned ON, but output variable (Output contact) of instance A is not turned ON. Because the current value of instance A does not reach the set value, output variable (Output contact) of instance A is not turn ON.

Structure of instance

An instance consists of the following data areas.

Data area	Description
Local label area	Used to assign local labels of the function block.
Local latch label area	Used to assign latched local labels of the function block.

Capacity of instance

The capacity of each data area of an instance should be calculated as follows.

Local label area

Capacity of local label area of instance = Total capacity of data of non-latched local labels + Capacity of reserved area

Breakdown	Description
Capacity of non-latched local labels	Total capacity of the data areas used for local labels.

Breakdown	Description
Capacity of reserved area	The capacity of the area reserved to add non-latched local labels and local instances when executing the online program change function. (fixed at 48 words)

Local latch label area

Capacity of local latch label area of instance = Total capacity of data of latched local labels + Capacity of reserved area

Breakdown	Description
Capacity of latched local labels	Total capacity of the data areas used for latched local labels.
Capacity of reserved area	The capacity of the area reserved to add latched local labels and local instances when executing the online program change function. (fixed at 16 words)

The local label area capacity is assigned by using the engineering tool. For details, refer to the following.

 GX Works3 Operating Manual

EN/ENO

An EN (enable input) and ENO (enable output) can be appended to a function block, in the same way as a function, to control its execution.

 Page 13 EN/ENO

An actual argument must be assigned to EN when the instance of the function block to which an EN/ENO is added is called.

Creating programs

The program of a function block can be created by using the engineering tool.



 Navigation window ⇒ "FB/FUN" ⇒ Right-click ⇒ "Add New Data"

The created program is stored in the FB/FUN file.

 [CPU Parameter] ⇒ "Program Setting" ⇒ "FB/FUN File Setting"

Up to 64 programs can be stored in one FB/FUN file.

For details on program creation, refer to the following.

Item	Reference
How to create function programs	 GX Works3 Operating Manual
Number of FB/FUN files that can be written to a CPU module	 User's manual (Startup)

■Type of programs

There are two types of function blocks and the program of each function block type is stored in different ways.

- Macro type function block
- Subroutine type function block

For details, refer to the following.

 Page 19 Operation overview

The above cannot be selected for module function blocks, standard functions, and standard function blocks.

■Applicable devices and labels

The following table lists the devices and labels that can be used by function block programs.

○: Applicable, △: Applicable only by instructions (Not applicable as a label indicating a program step)

Type of device/label		Availability
Label (other than pointer type)	Global label	○
	Local label	○
Label (pointer type)	Pointer-type global label	△
	Pointer-type local label	○
Device	Global device	○
Pointer	Global pointer	△

Operation overview

Macro type function blocks

The program of a macro type function block is loaded by the calling source program according to the execution flow. At the time of program execution, the loaded program is executed in the same way as the main program.

Use a macro type function block when giving higher priority to the processing speed of the program.

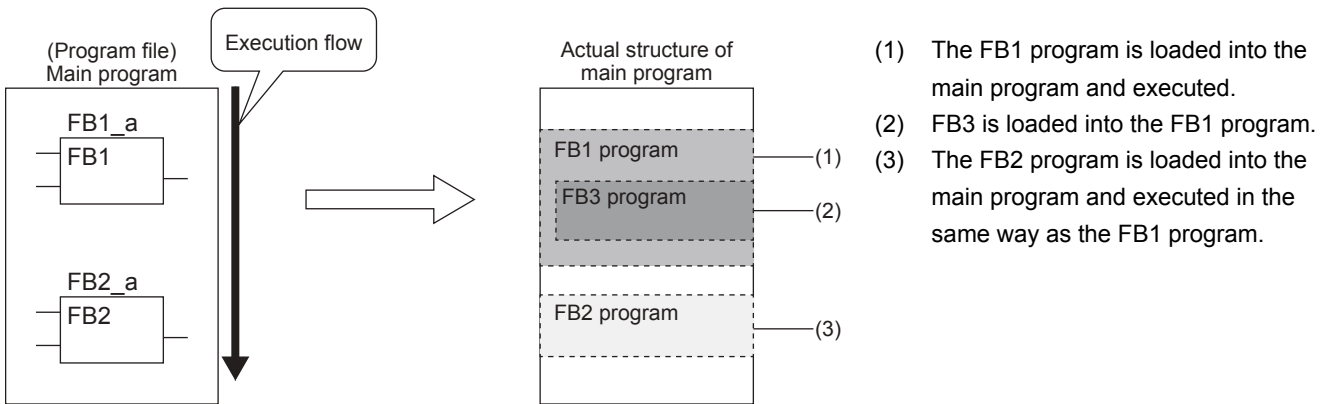

Subroutine type function blocks

The program of a subroutine type function block is stored in the FB/FUN file and called by the calling source program when executed.

Use a subroutine type function block to reduce the program size.

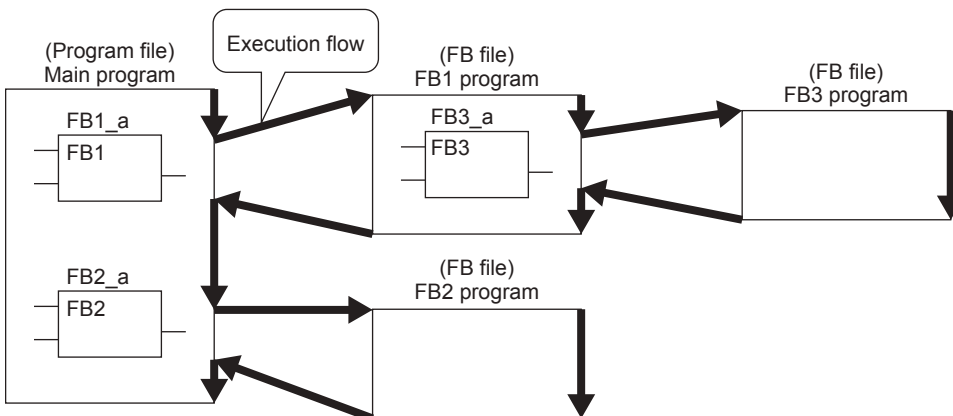

You can nest all of function blocks, and functions up to 32 times.

Macro type function blocks

Calling source

When calling a macro type function block, the calling source loads the call-target program during compilation.

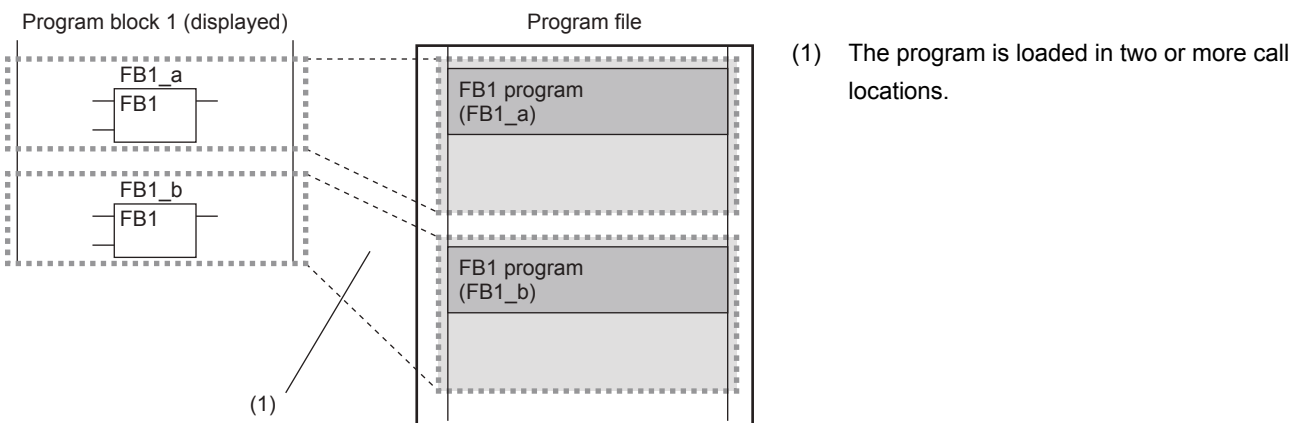

■Program

The number of steps required for a function block program is the total number of instruction steps, like normal programs. For the number of steps required for each instruction, refer to the following.

📖 Programming manual (Instructions, Standard Functions/Function Blocks)

Subroutine type function blocks

■Calling source

When calling a subroutine type function block, the calling source generates the processing that passes the argument and return value before and after the call processing.

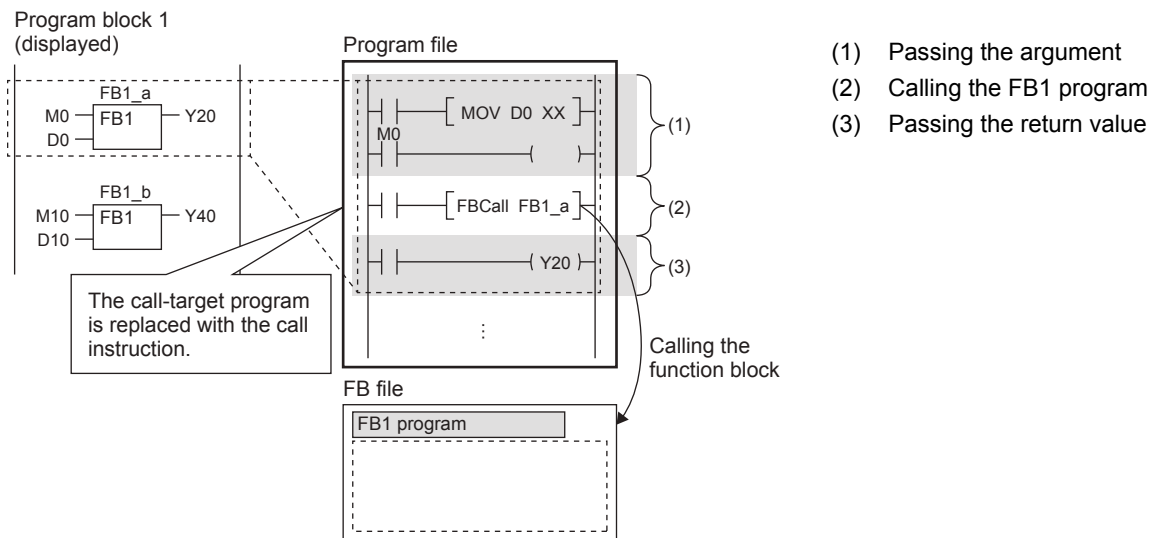

Passing the argument

The instruction used to pass the argument differs depending on the class and data type of the argument. The following table summarizes the instructions that can be used to pass the argument.

Argument class	Data type	Instruction used	Number of steps
VAR_INPUT VAR_IN_OUT	Bit	LD+OUT LD+MOVB (Which of the above instructions to use is determined by the combination of the programming language, type of function, and type of input argument.)	For the number of steps required for each instruction, refer to the following. 📖 Programming manual (Instructions, Standard Functions/Function Blocks)
	Word [Unsigned]/Bit String [16-bit] Double Word [Unsigned]/Bit String [32-bit] Word [Signed] Double Word [Signed]	LD+MOV LD+DMOV	
	FLOAT [Single Precision]	LD+EMOV	
	Time	LD+DMOV	
	String(32)	LD+\$MOV	
	Array, Structure	LD+BMOV	

Calling the program

A total of 12 steps are required to call the function block program.

Passing the return value

The instruction used to pass the return value differs depending on the class and data type of the argument. The following table summarizes the instructions that can be used to pass the return value.

Argument class	Data type	Instruction used	Number of steps
VAR_OUTPUT VAR_IN_OUT	Same as for passing the argument.	Same as for passing the argument.	Same as for passing the argument.

The following table lists the number of steps required for EN/ENO.

Item	Number of steps
EN	6
ENO	4

Point

The number of steps may increase or decrease, depending on the following conditions.

- The actual argument or return value of the function block are index-modified.
- The address specifying the device exceeds 16 bits in length.
- Nibble specification is performed.

Program

The number of steps required for a function block program is the total number of instruction steps, like normal programs.

For the number of steps required for each instruction, refer to the following.

📖 Programming manual (Instructions, Standard Functions/Function Blocks)

Precautions

Global pointer/pointer type global labels

Global pointer and pointer type global labels cannot be used as labels indicating program steps in the function block program.

When an index register is used

When an index register is used in the function block program, ladder programs for saving and returning the index register values are required to protect the values.

Setting the index register data to 0 after saving can prevent an error that could be caused by an index modification validity check. (Whether the device number exceeds the device range or not is checked.)

Ex.

A program that saves the values in the index registers Z1 and Z2 before the program execution and returns the saved values after the program execution

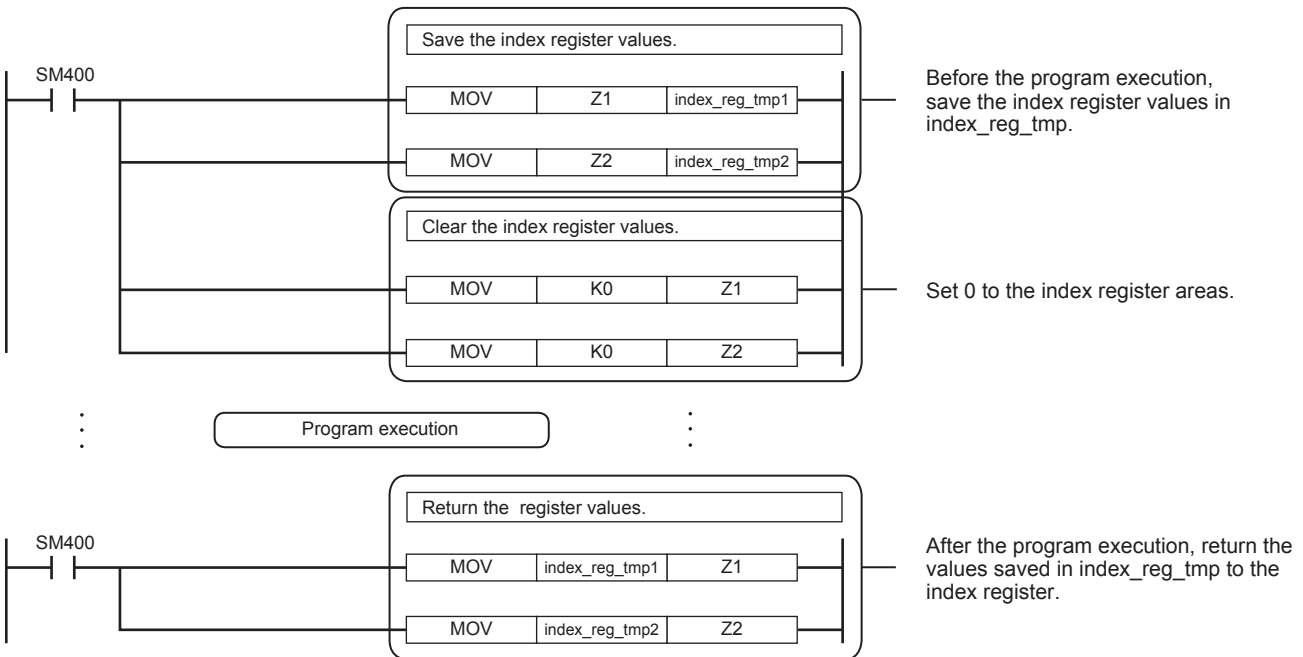

4 LABELS

Labels are variables for I/O data or internal processing, specified by a character string.

Users can create a program without considering devices or buffer memory size by using labels.

Thus, a program, where labels are used, can be reused in a system with a different module configuration easily.

When labels are used, there are some precautions on programming and functions used. For details, refer to the following.

 Page 31 Precautions

4.1 Type

This manual describes the following types of label.

- Global labels
- Local labels

Global labels

Global labels are labels that can be shared by programs in a project. Global labels can be used in all the programs in a project.

Global labels can be used in program blocks and function blocks.

When setting a global label, set the label name, class and data type, and assign a device.

■Device assignment

Devices can be assigned to global labels.

Item	Description
Label to which no device is assigned	<ul style="list-style-type: none">• Programming without concern to devices is possible.• Defined labels are allocated to the label area or latch label area in the device/label memory.
Label to which a device is assigned	<ul style="list-style-type: none">• If a device is to be programmed as a label referring to a device that is being used for input or output, the device can be assigned directly.• Defined labels are allocated to the device area in the device/label memory.

Local labels

Local labels are labels that can be used in each POU only. Local labels that are not included in POUs cannot be used.

When setting a local label, set the label name, class, and data type.

Point

There are other types of labels available in addition to global labels and local labels.

■System labels

System labels can be shared among iQ Works-compatible products and are managed by MELSOFT Navigator. Global labels registered as system labels can be monitored or accessed using the system labels on GOT.

For details, refer to the following.

 iQ Works Beginner's Manual

■Module labels

Module labels are labels defined uniquely by each module. Module labels are automatically generated by the engineering tool from the module used, and can be used as a global label.

For details, refer to the following.

 MELSEC iQ-F FX5 CPU Module Function Block Reference

4.2 Class

The label class indicates how each label can be used from which POU.

The selectable class varies depending on the POU.

Global label				
Class	Description	Applicable POU		
		Program block	Function block	Function
VAR_GLOBAL	Common label that can be used in program blocks and function blocks	○	○	×
VAR_GLOBAL_CONSTANT	Common constant that can be used in program blocks and function blocks	○	○	×
VAR_GLOBAL_RETAIN	Latch type label that can be used in program blocks and function blocks	○	○	×
Local label				
Class	Description	Applicable POU		
		Program block	Function block	Function
VAR	Label that can be used within the range of declared POUs This label cannot be used in other POUs.	○	○	○
VAR_CONSTANT	Constant that can be used within the range of declared POUs This label cannot be used in other POUs.	○	○	○
VAR_RETAIN	Latch type label that can be used within the range of declared POUs This label cannot be used in other POUs.	○	○	×
VAR_INPUT	Label that inputs to a function or a function block. This label receives a value, and cannot be changed in POUs.	×	○	○
VAR_OUTPUT	Label that outputs a value from a function or a function block	×	○	○
VAR_OUTPUT_RETAIN	Latch type label that outputs a value from a function or a function block	×	○	×
VAR_IN_OUT	Local label which receives a value, outputs it from a POU, and can be changed in POUs	×	○	×
VAR_PUBLIC	Label that can be accessed from other POUs	×	○	×
VAR_PUBLIC_RETAIN	Latch type label that can be accessed from other POUs	×	○	×

4

4.3 Data Type

Labels are classified into several data types according to the bit length, processing method, or value range.

The following two data types are provided.

- Elementary data type
- Generic data type (ANY)

Elementary data type

The following data types are available as the elementary data type.

Data type	Description	Value range	Bit length	
Bit	BOOL	Represents binary status, such as ON or OFF	0 (FALSE), 1 (TRUE)	1-bit
Word [Unsigned]/Bit String [16-bit]	WORD	Represents 16-bit	0 to 65535	16-bit
Double Word [Unsigned]/Bit String [32-bit]	DWORD	Represents 32-bit	0 to 4294967295	32-bit
Word [Signed]	INT	Handles positive and negative integer values	-32768 to +32767	16-bit
Double Word [Signed]	DINT	Handles positive and negative double word integer values	-2147483648 to +2147483647	32-bit
FLOAT [Single Precision]	REAL	Handles the portion after the decimal point of the float (single precision) Effective digits: 7 (after the decimal point: 6)	-2^{128} to -2^{-126} , 0, 2^{-126} to 2^{128}	32-bit

Data type		Description	Value range	Bit length
Time ^{*1}	TIME	Handles values as d (day), h (hour), m (minute), s (second), or ms (millisecond)	T#-24d20h31m23s648 ms to T#24d20h31m23s647 ms ^{*2}	32-bit
String(32)	STRING	Handles a character string (character)	Up to 255 letters (half-width character)	Variable
Timer	TIMER	Structure that corresponds to a timer (T) of a device	☞ Page 24 Data types of timers and counters	
Retentive Timer	RETENTIVETIMER	Structure that corresponds to a retentive timer (ST) of a device		
Counter	COUNTER	Structure that corresponds to a counter (C) of a device		
Long Counter	LCOUNTER	Structure that corresponds to a long counter (LC) of a device		
Pointer	POINTER	Type that corresponds to a pointer (P) of a device (☞ User's manual (Application))		

*1 The time data is used in the time data type function of standard functions. For the standard function, refer to the following.

☞ Programming manual (Instructions, Standard Functions/Function Blocks)

*2 When using a constant for a label of the time data, prefix "T#" to the label.

■ Data types of timers and counters

The data types of a timer, retentive timer, counter, and long counter are structures that have contacts, coils, and current values.

Data type		Member name	Data type of member	Description	Value range
Timer	TIMER	S	Bit	Indicates contacts. The operation is the same as the contact of a timer device (TS).	0 (FALSE), 1 (TRUE)
		C	Bit	Indicates coils. The operation is the same as the coil of a timer device (TC).	0 (FALSE), 1 (TRUE)
		N	Word [unsigned]/Bit String [16-bit]	Indicates a current value. The operation is the same as the current value of a timer device (TN).	0 to 32767 ^{*1}
Retentive Timer	RETENTIVETIMER	S	Bit	Indicates contacts. The operation is the same as the contact of a retentive timer device (STS).	0 (FALSE), 1 (TRUE)
		C	Bit	Indicates coils. The operation is the same as the coil of a retentive timer device (STC).	0 (FALSE), 1 (TRUE)
		N	Word [unsigned]/Bit String [16-bit]	Indicates a current value. The operation is the same as the current value of a retentive timer device (STN).	0 to 32767 ^{*1}
Counter	COUNTER	S	Bit	Indicates contacts. The operation is the same as the contact of a counter device (CS).	0 (FALSE), 1 (TRUE)
		C	Bit	Indicates coils. The operation is the same as the coil of a counter device (CC).	0 (FALSE), 1 (TRUE)
		N	Word [unsigned]/Bit String [16-bit]	Indicates a current value. The operation is the same as the current value of a counter device (CN).	0 to 32767
Long Counter	LCOUNTER	S	Bit	Indicates contacts. The operation is the same as the contact of a long counter device (LCS).	0 (FALSE), 1 (TRUE)
		C	Bit	Indicates coils. The operation is the same as the coil of a long counter device (LCC).	0 (FALSE), 1 (TRUE)
		N	Double Word [unsigned]/Bit string [32-bit]	Indicates a current value. The operation is the same as the current value of a long counter device (LCN).	^{*2}

*1 The unit of the current value is specified by instruction name.

*2 When use a long counter in the OUT LC instruction: 0 to 4294967295

When use a long counter in the UDCNTF instruction: -2147483648 to +2147483647

For the operation of each device, refer to the following.

☞ User's manual (Application)

The specification method of each member is the same as the member specification of the structure data type. (☞ Page 28 Structures)

Generic data type (ANY)

The generic data type indicates data type of a label which combines several basic data types. The data type name begins with "ANY".

The generic data type is used when multiple data types are available in arguments or return values etc. of a function of a function block.

Labels defined as generic data types can be used for any sub-level data type.

For the types of generic data types and the primitive data types, refer to the following.

 Programming manual (Instructions, Standard Functions/Function Blocks)

Definable data types

The following tables list the definable data types possibilities for each label class.

Global label	
Class	Definable data type
VAR_GLOBAL	Primitive data type, array, structure, function block
VAR_GLOBAL_CONSTANT	Primitive data type ^{*1}
VAR_GLOBAL_RETAIN	Primitive data type ^{*1} , array, structure
Local label (program block)	
Class	Definable data type
VAR	Primitive data type, array, structure, function block
VAR_CONSTANT	Primitive data type ^{*1}
VAR_RETAIN	Primitive data type ^{*1} , array, structure
Local label (function)	
Class	Definable data type
VAR	Primitive data type ^{*2} , array, structure
VAR_CONSTANT	Primitive data type ^{*1}
VAR_INPUT	Primitive data type ^{*1*2} , array, structure
VAR_OUTPUT	
Return value	
Local label (function block)	
Class	Definable data type
VAR	Primitive data type, array, structure, function block
VAR_CONSTANT	Primitive data type ^{*1}
VAR_RETAIN	Primitive data type ^{*1} , array, structure
VAR_INPUT	
VAR_OUTPUT	
VAR_OUTPUT_RETAIN	
VAR_IN_OUT	
VAR_PUBLIC	
VAR_PUBLIC_RETAIN	

*1 The pointer type cannot be defined.

*2 None of the timer, retentive timer, long timer, counter, long timer, long retentive timer, and long counter types can be defined.

4.4 Arrays

An array represents a consecutive accumulation of the same data type labels, under the same name. Arrays can be defined by the elementary data types or structures or function blocks.

The maximum number of arrays differs depending on the data types.

■ One-dimensional array

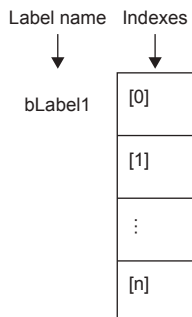

■ Two-dimensional array

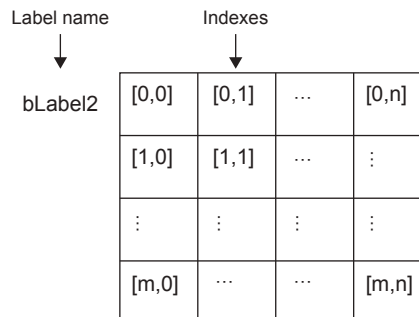

Definition of arrays

■ Array elements

When an array is defined, the number of elements, or the length of array, must be determined. For the range of the number of elements, refer to the following.

☞ Page 27 Maximum number of array elements

■ Definition format

The following table lists definition format examples up to three dimensions.

The range from the array start value to the array end value is the number of elements.

Number of array dimensions	Format	Remarks
One dimension	Array of elementary data type/structure name (array start value .. array end value) (Definition example) Bit (0..2)	<ul style="list-style-type: none"> For elementary data types: ☞ Page 23 Elementary data type For structured data types: ☞ Page 28 Structures
Two dimensions	Array of elementary data type/structure name (array start value .. array end value, array start value .. array end value) (Definition example) Bit (0..2, 0..1)	
Three dimensions	Array of elementary data type/structure name (array start value .. array end value, array start value .. array end value, array start value .. array end value) (Definition example) Bit (0..2, 0..1, 0..3)	

How to use arrays

To identify individual labels of an array, append an index enclosed by "[]" after the label name.

For an array with two or more dimensions, delimit indexes in "[]" by using "comma (,)"

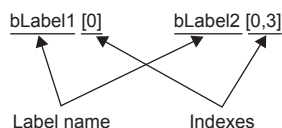

Type	Specification example	Remarks
Constant	bLabel1[0]	An integer equal to or greater than 0 can be specified. Decimal constant or hexadecimal constant can be specified.
Device	bLabel1[D0]	A word device or double-word device can be specified.
Label	bLabel1[uLabel2]	The following data types can be specified. <ul style="list-style-type: none"> Word [unsigned]/bit string [16 bits] Double word [unsigned]/bit string [32 bits] Word [signed] Double word [signed]
Expression	bLabel1[5+4]	Expressions can be specified only in ST language.

- The data storage location becomes dynamic by specifying a label for the array index. This enables arrays to be used in a program that executes loop processing. The following is a program example that consecutively stores "1234" in the "uLabel4" array.

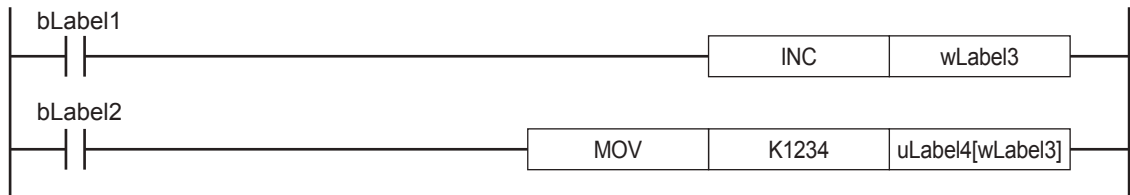

- In the case of the ladder diagram, arrays can be used with element numbers omitted. When the element number is omitted, it is converted to the starting number of the array element. For example, when the label name you define is "boolAry" and the data type is "bit (0..2,0..2)", then "boolAry[0,0]" and "boolAry" are treated in the same way.
- A multidimensional array can be specified as setting data of an instruction, function, or function block using arrays. In that case, the rightmost element in the multidimensional array is treated as the first dimension.

Maximum number of array elements

The maximum number of array elements differs depending on data types.

Data type	Setting range
Bit	1 to 32768
Word [Unsigned]/Bit String [16-bit]	
Double Word [Unsigned]/Bit String [32-bit]	
Word [Signed]	
Double Word [Signed]	
FLOAT [Single Precision]	
Time	
Timer	
Retentive Timer	
Counter	
Long Counter	
Function Block	
String(32)	

Precautions

■When an interrupt program is used

When a label or device is specified for the array index, the operation is performed with a combination of multiple instructions. For this reason, if an interrupt occurs during operation of the label defined as an array, data inconsistency may occur producing an unintended operation result.

To prevent data inconsistency, create a program using the DI/EI instructions that disables/enables interrupt programs as shown below.

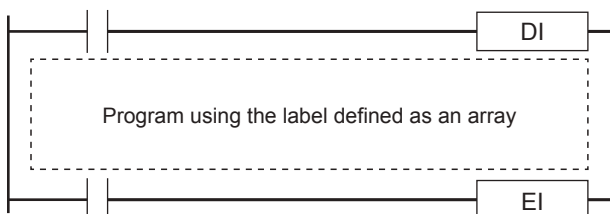

For the DI/EI instructions, refer to the following.

📖 Programming manual (Instructions, Standard Functions/Function Blocks)

Arrays of structures

Structures can also be used as arrays.

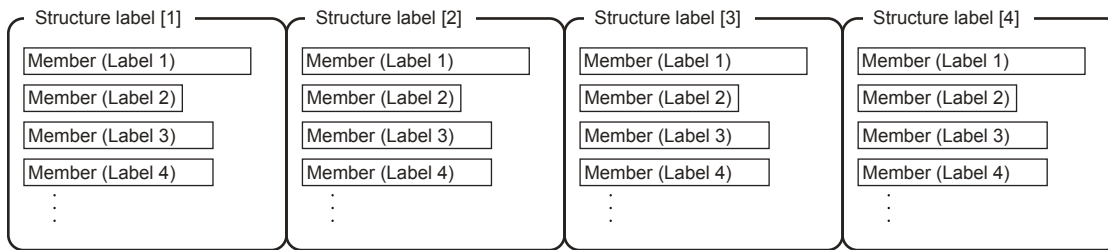

When a structure is declared as an array, append an index enclosed by "[" after the structure label name.

The array of structure can be specified as arguments of functions and function blocks.

Ex. When using an element of the structured array

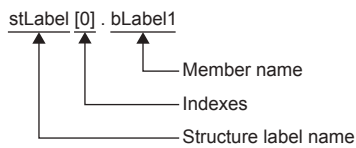

Data types that can be specified

The following data types can be specified as a member of a structure.

- Elementary data type
- Pointer type
- Arrays
- Other structures

Structure types

The following data types are defined as a structure beforehand.

Type	Reference
Timer type	Page 23 Data Type
Retentive Timer type	
Counter type	
Long Counter type	

4.6 Constant

Types of constants

The following table shows the expressions for setting a constant to a label.

Applicable data type	Type	Expression	Example
Bit	Boolean data	Input "TRUE" or "FALSE".	TRUE, FALSE
	Binary	Append "2#" in front of a binary number.	2#0, 2#1
	Octal	Append "8#" in front of an octal number.	8#0, 8#1
	Decimal	Directly input a decimal number, or append "K" in front of a decimal number.	0, 1, K0, K1
	Hexadecimal	Append "16#" or "H" in front of a hexadecimal number.	16#0, 16#1, H0, H1
<ul style="list-style-type: none"> • Word [Unsigned]/Bit String [16-bit] • Double Word [Unsigned]/Bit String [32-bit] • Word [Signed] • Double Word [Signed] 	Binary ^{*1}	Append "2#" in front of a binary number.	2#0010, 2#01101010, 2#1111_1111
	Octal ^{*1}	Append "8#" in front of an octal number.	8#0, 8#337, 8#1_1
	Decimal ^{*1}	Directly input a decimal number or append "K" in front of a decimal number.	123, K123, K-123, 12_3
	Hexadecimal ^{*1}	Append "16#" in front of a hexadecimal number. Or append "H" in front of a value.	16#FF, HFF, 16#1_1
FLOAT [Single Precision]	Real number ^{*1}	Directly input a real number, or append "E" in front of a real number.	2.34, E2.34, E-2.34, 3.14_15
	Real number (exponent expression)	Append "E" in front of an exponent expression or a real number. Append "+" in front of exponent part.	1.0E6, E1.001+5
String(32)	Character string	Enclose a character string with single quotations (').	'ABC'
Time	Time	Append "T#" in front.	T#1h, T#1d2h3m4s5ms

*1 In the binary notation, the octal notation, the decimal notation, the hexadecimal notation, and the real number notation, values can be delimited by an underscore (_) to make programs easy to read. (In the program processing, underscores are ignored.)

When "\$" is used in character string type data

"\$" is used as an escape sequence. Two hexadecimal numbers after "\$" are recognized as an ASCII code, and characters corresponding to the ASCII code are inserted in the character string. If no ASCII code for the two hexadecimal numbers after "\$" exists, a conversion error occurs. However, when any of the following characters is described after "\$", no error occurs.

Expression	Symbol that is used in character string, or printer code
\$\$	\$
\$'	'
\$"	"
\$L or \$l	Line feed
\$N or \$n	Newline
\$P or \$p	Page (form feed)
\$R or \$r	Return
\$T or \$t	Tab

4.7 Precautions

Functions with limitations

In the following functions, there is a limitation on label use.

Item	Description
Trigger of an event execution type program	Labels cannot be used. Consider taking the following measures. <ul style="list-style-type: none">• Use devices.• Define a label to be used as a global label and assign devices to the global label.
Intelligent function module refresh setting	Labels cannot be used. Consider taking the following measures. <ul style="list-style-type: none">• Use devices.

■Defining and using a global label with a device assigned

Define a global label following the procedure below, and use it when the functions having restriction on the use of labels are executed.

Since the device area in the device/label memory is used, reserve device area capacity.

1. Reserve the device area to be used.

🔗 CPU Parameter ⇒ Memory/Device Setting ⇒ Device/Label Memory Area Capacity Setting

2. Define a label as a global label, and assign a device manually.
3. Use the label defined in step 2 for the functions having no restrictions on the use of labels. Use the device assigned to the label for the function having restrictions on the use of labels.

■Copying the label data into a specified device

Copy the label data into a specified device following the procedure below, and use the copy-target device.

Since the device area in the device/label memory is used, reserve device area capacity.

1. Reserve the device area to be used.

🔗 CPU Parameter ⇒ Memory/Device Setting ⇒ Device/Label Memory Area Capacity Setting

2. Create a program using the label. The following is the program example for copying the data. (The data logging function uses the data in udLabel1.)

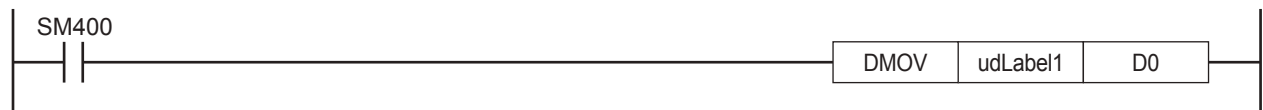

3. Use the device where the data has been transferred in step 2 for the function having restrictions on the use of labels. (In the program example in step 2, use D0.)

Point

When copying a value of a label to another device by a transfer instruction, note that the number of program steps increases. In addition, when adding a transfer instruction on a program, consider execution timing of the function to be used.

Precautions for creating programs

When specifying a label as an operand used in instructions, match the data type of the label with that of the operand. In addition, when specifying a label as an operand used in instructions that control continuous data, specify the data range used in instructions within the data range of the label.

Ex. SFT(P) instruction

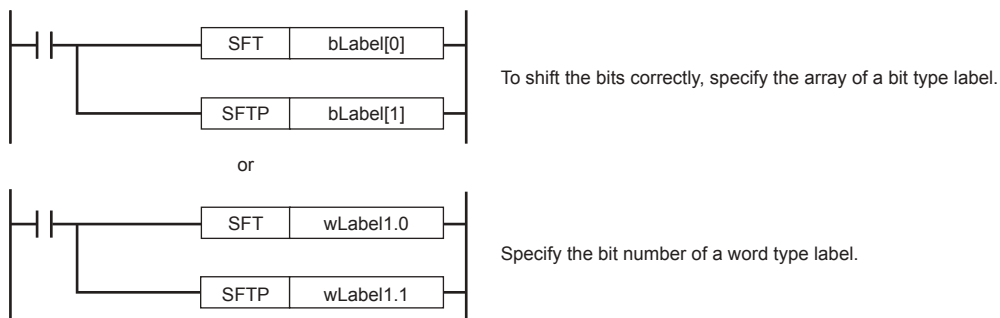

Ex. SFR(P) instruction

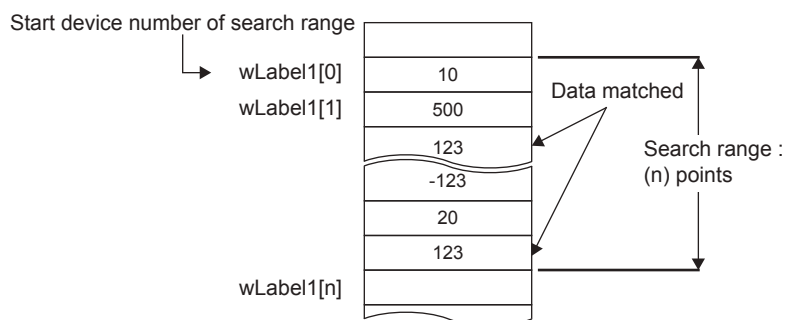

Specify a label which has a larger data range than the search range (n) points.

Limitations on label names

Label names have the following limitations:

- A label name must start with a nonnumeric character or underscore (_). It cannot start with a number.
- Reserved words cannot be used as label names.

For details of reserved words, refer to the following.

GX Works3 Operating Manual

5 LADDER DIAGRAM

Ladder diagram is a language that describes the sequence control by indicating logical operations consisting of "AND" or "OR" with combinations of series connections and parallel connections in a ladder consisting of contacts and coils.

5.1 Configuration

With the ladder diagram, the following ladder can be created.

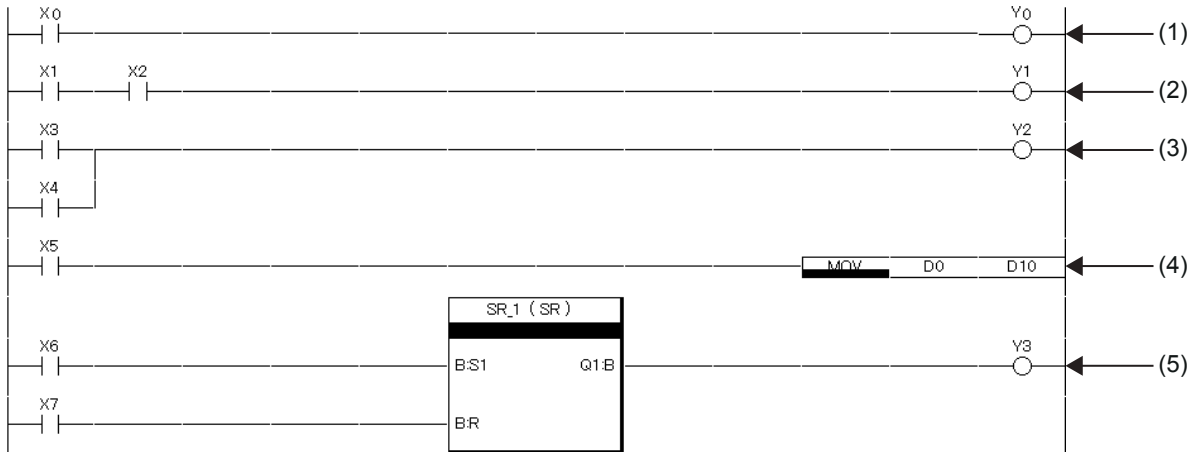

- (1) A ladder consists of contacts and coils
- (2) A ladder connected in series
- (3) A ladder connected in parallel
- (4) A ladder where instructions are used
- (5) A ladder where standard functions and function blocks are used

Ladder symbols

This section shows ladder symbols that can be used for programming in the ladder diagram.

Element	Symbol	Description
NO contact		Turns on when a specified device or label is ON.
NC contact		Turns on when a specified device or label is OFF.
Rising edge		Turns on at the rising edge (OFF to ON) of a specified device or label.
Falling edge		Turns on at the falling edge (ON to OFF) of a specified device or label.
Negated rising edge		Turns on when a specified device or label is OFF or ON, or at the falling edge (ON to OFF) of a specified device or label.
Negated falling edge		Turns on when a specified device or label is OFF or ON, or at the rising edge (OFF to ON) of a specified device or label.
Conversion of operation result to leading edge pulse		Turns on at the rising edge (OFF to ON) of an operation result. Turns off when the operation result is other than the rising edge.
Conversion of operation result to trailing edge pulse		Turns on at the falling edge (ON to OFF) of an operation result. Turns off when the operation result is other than the falling edge.
Inverting the operation result		Inverts the operation just before this instruction.
Coil		Outputs an operation result to a specified device or a label.
Instruction		Executes an instruction specified in [].
Turn-back		Turns back a circuit by creating a turn source symbol and a turn destination symbol when the number of contacts exceeds the number of contacts that can be created in one line.

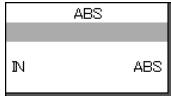
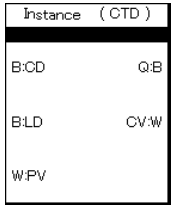
Element	Symbol	Description
Function		Executes a function. <ul style="list-style-type: none"> • How to create functions (GX Works3 Operating Manual) • Standard function (MELSEC iQ-F FX5 Programming Manual (Instructions, Standard Functions/Function Blocks))
Function block		Executes a function block. <ul style="list-style-type: none"> • How to create function blocks (GX Works3 Operating Manual) • Standard function blocks (MELSEC iQ-F FX5 Programming Manual (Instructions, Standard Functions/Function Blocks)) • Module function blocks (MELSEC iQ-F FX5 CPU Module Function Block Reference)

Program execution order

The program is executed in order of the following numbers.

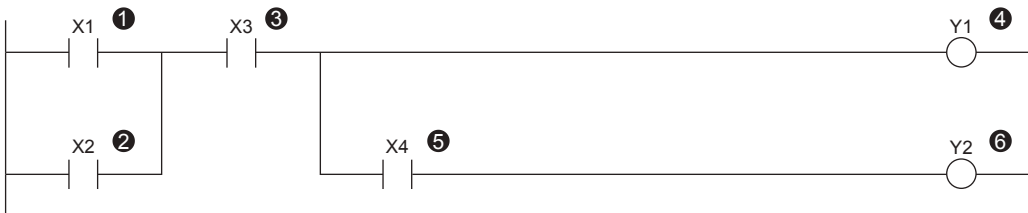

When executing the program above, Y1 and Y2 turn on corresponding to turning ON or OFF of X1 to X4 as shown below.

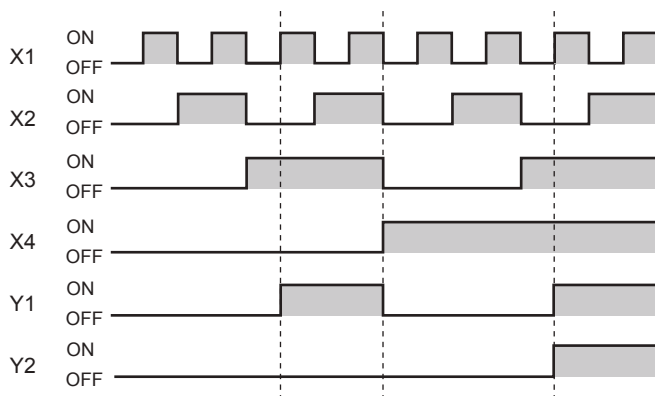

5.2 Inline ST

Inline ST is a function that creates, edits and monitors inline ST box that displays an ST program in a cell of an instruction that is equivalent to a coil in the ladder editor.

Numerical operations or character string operations can be created easily in a ladder program.

- Program with the inline ST

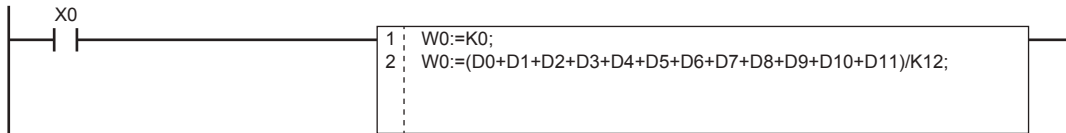

- Program without the inline ST

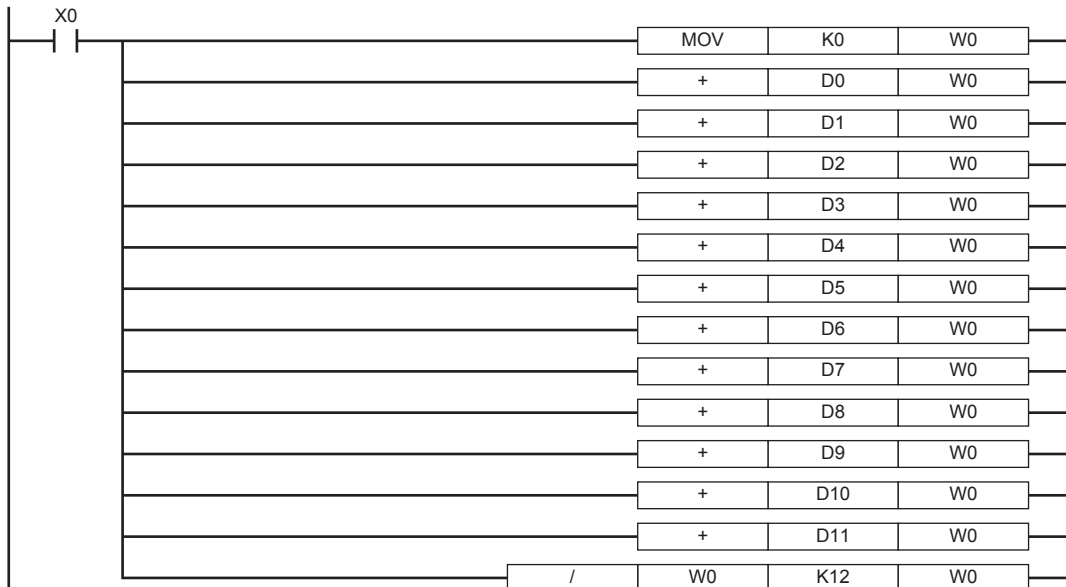

Specifications

For the specifications of the inline ST, refer to the ST language specifications.

📖 Page 37 ST LANGUAGE

Precautions

- Only one inline ST can be created in one line of a ladder program.
- Creating both a function block and an inline ST box in one line of a ladder program is impossible.
- Creating an inline ST box in a position of an instruction that is equivalent to a contact creates an inline ST box in a position of an instruction that is equivalent to a coil.
- The maximum number of characters that can be input in an inline ST is 2048. (Line feed is counted as one character.)
- In inline ST, do not use rising execution instructions, falling execution instructions, special timer instructions, or standard function blocks (edge detection function blocks and counter function blocks) as they may not work properly.
- When the RETURN syntax is used in an inline ST, the processing inside the inline ST box ends, and the processing inside the program block does not end.

5.3 Statements and Notes

In a ladder program, statements and notes can be displayed.

Statements

By using statements, users can append comments to circuit blocks. Appending statements makes the processing flow easy to understand.

Statements include line statements, P statements, and I statements.

A line statement can be displayed on a tree view of the Navigation window.

■Line statement

A comment is appended to a ladder block as a whole.

■P statement

A comment is appended to a pointer number.

■I statement

A comment is appended to an interrupt pointer number.

Notes

By using notes, users can append comments to coils and instructions in a program.

Appending notes makes the details of coils and application instructions easy to understand.

Types of statements and notes

"PLC" and "Peripheral" are the types of statements and notes.

Type	Type	Description
PLC	<ul style="list-style-type: none">• Line statement• P statement• I statement• Note	Statements and notes can be stored on the CPU module. PLC statement uses the following number of steps. (When all the characters are input in one-byte characters. Decimal fraction is rounded up.) <ul style="list-style-type: none">• Without character: 3 steps• With character: $4 + (\text{Number of characters} + 2 + 14) / 5 + \text{Number of characters (steps)}$
Peripheral	<ul style="list-style-type: none">• Line statement• P statement• I statement• Note	Statements and notes cannot be stored on the CPU module. (Only the position information can be stored.) Statements and notes must be saved on a peripheral device. One statement or note line uses one step. A * symbol is prefixed to the entered text automatically.

6 ST LANGUAGE

The ST language is one of the languages supported by IEC 61131-3, the international standard that defines the description methods for logic. ST language is a text programming language with a grammatical structure similar to C language. ST language is suitable for programming some complicated processing that cannot be easily described using ladder diagram. ST language supports control syntaxes, operational expressions, function blocks (FBs), and functions (FUNs). Therefore, the following description can be made.

Ex. Control syntaxes using selective branches with conditional statements and repetition by iteration statements

```
(* Control conveyors of Line A to C. *)
CASE Line OF
  1: Start_switch := TRUE; (* The conveyor starts. *)
  2: Start_switch := FALSE; (* The conveyor stops. *)
  3: Start_switch := TRUE; (* The conveyor stops with an alarm. *)
  ELSE Alarm_lamp := TRUE;
END_CASE;

IF Start_switch = TRUE THEN (* The conveyor starts and performs processing 100 times. *)
  FOR Count := 0
    TO 100
    BY 1 DO
      Count_No := Count_No + 1;
    END_FOR;
  END_IF;
```

Ex. Expressions using operators (such as *, /, +, -, <, >, and =)

```
D0 := D1* D2 + D3 / D4 -D5;
IF D0 > D10 THEN
  D0 := D10;
END_IF;
```

Ex. Calling a defined function block

```
//FB data name      : LINE1_FB
//Input variable    : I_Test
//Output variable   : O_Test
//Input/output variable : IO_Test
//FB label name     : FB1
FB1(I_Test :=D0,O_Test => D1,IO_Test := D100);
```

Ex. Calling a standard function

```
(* Convert BOOL data type to INT/DINT data type. *)
wLabel2 := BOOL_TO_INT (bLabel1);
```

6.1 Configuration

Operators and syntaxes are used for programming in ST language.

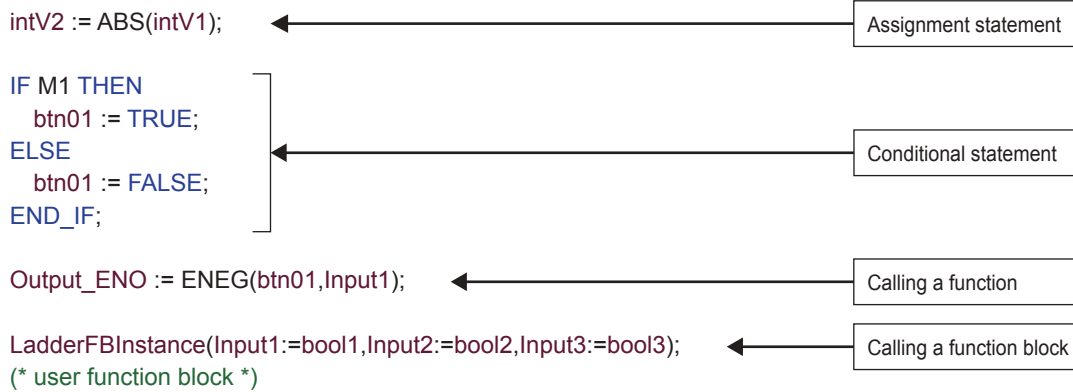

A statement must end with ";" (semicolon).



Spaces, tabs, and line feeds can be inserted anywhere between an operator and data.



Comments can be inserted in a program.

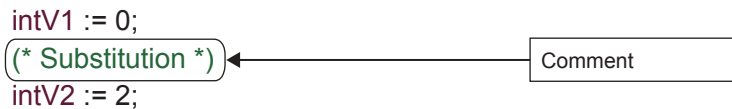

Constituent elements of a program

A ST program consists of the following elements.

Item	Example	Reference	
Delimiter	;; ()	Page 39 Delimiter	
Operator	+, -, <, >, =	Page 39 Operator	
Reserved word	Syntax	IF, CASE, WHILE, RETURN	Page 40 Syntax
	Device	X0, Y10, M100	User's manual (Application)
	Data type	BOOL, DWORD	Page 23 Data Type
	Function	ADD, REAL_TO_STRING_E	Programming manual (Instructions, Standard Functions/Function Blocks)
Constant	123, 'abc'	Page 47 Constant	
Label	Switch_A	Page 47 Label and device	
Comment	(* Turn ON *), //Turn ON, /*Turn ON*/	Page 48 Comment	
Other symbols	One-byte space, line feed code, tab code	—	

- Use one-byte delimiters, operators, and reserved words.
- For details of reserved words, refer to the following.
 - 📖 GX Works3 Operating Manual

Delimiter

The following delimiters are provided in ST language for clarifying the program structure.

Symbol	Description
()	Parenthesized
[]	Specification of an array element
. (period)	Specification of members of the structure or function block
, (comma)	Separation of arguments
: (colon)	Device type specifier
; (semicolon)	End of a sentence
' (single quotation mark)	Description of a character string
.. (two periods)	Specification of an integer range

Operator

The following shows the operators used in a ST program and the target data types and operation result data types for each operator.

Operator	Target data type	Operation result type
*, /, +, -	ANY_NUM	ANY_NUM
<, >, <=, >=, =, <>	ANY_SIMPLE	Bit
MOD	ANY_INT	ANY_INT
AND, &, XOR, OR, NOT	ANY_BIT	ANY_BIT
**	ANY_REAL (Base) ANY_NUM (Exponent)	ANY_REAL

The following table shows the priorities of the operators.

Operator	Description	Example	Priority
()	Parenthesized expression	(2+3)*(4+5)	1
Function ()	Argument of a function	CONCAR('AB', 'CD')	2
**	Exponentiation	3.0**4	3
-	Inversion of sign	-10	4
NOT	Bit type complement	NOT TRUE	4
*	Multiplication	10 * 20	5
/	Division	20 / 10	5
MOD	Modulus operation	17 MOD 10	5
+	Addition	1.4 + 2.5	6
-	Subtraction	3 - 2	6
<, >, <=, >=	Comparison	10 > 20	7
=	Equality	T#26h = T#1d2h	8
<>	Inequality	8#15 <> 13	8
&, AND	Logical AND	TRUE AND FALSE	9
XOR	Exclusive OR	TRUE XOR FALSE	10
OR	Logical OR	TRUE OR FALSE	11

- If an expression includes multiple operators with the same priority, the operation is performed from the leftmost operator.
- Up to 1024 operators can be used in one statement.

Syntax

The following table shows the types of statements that can be used in a ST program.

Item	Description	Reference
Assignment statement	Assignment statement	☞ Page 40 Assignment statement
Sub-program control statement	Function block call statement, function call statement	☞ Page 41 Sub-program control statement
	RETURN statement	
Conditional statement	IF statement (IF, IF...ELSE, IF...ELSIF)	☞ Page 42 Conditional statement
	CASE statement	
Iteration statement	FOR statement	☞ Page 43 Iteration statement
	WHILE statement	
	REPEAT statement	
	EXIT statement	

Write statements using half width characters.

Assignment statement

Format	Description	Example
<Left side> := <Right side> ;	The assignment statement assigns the result of the right side expression to the label or device of the left side. The result of the right side expression and the data type of the left side need to be the same data type.	intV1 := 0; intV2 := 2;

When an array type label or a structure label is used, check the data types of the left side and right side of the assignment statement.

When an array type label is used, the data type and the number of elements need to be the same for the left side and right side. Do not specify elements.

Ex. intAry1 := intAry2;

When a structure label is used, the data type needs to be the same for the left side and right side.

Ex. dutVar1 := dutVar2;

■ Automatic conversion of data types

In the ST language, if a different data type is assigned or a different arithmetic operation is described, the data type may be automatically converted.

Ex. Example of automatic conversion

```
dintLabel1 := intLabel1;
// Assignment statement : Automatically convert the INT type variable (intLabel1) to a DINT type variable,
// and assign it the DINT type variable (dintLabel1).
```

```
dintLabel1 := dintLabel2 + intLabel1;
// Arithmetic operation expression : Automatically convert the INT type variable (intLabel1) to a DINT type
// variable, and perform DINT type addition.
```

Type conversion is performed in an assignment statement, input argument pass to a function block and function (VAR_INPUT part), and an arithmetic operation.

To avoid the deletion of the data during type conversion, only conversion from smaller type to larger type is performed. Of the elementary data types, type conversion is performed only for the following data types among basic data types are the targets of a type conversion.

Data type	Description
Word [Signed]	In the case of a double word [signed] after conversion, the conversion is automatically made into a value with a sign extension. In the case of a single-precision real, an automatic conversion is made into the same value as the integer before the conversion.*1
Word [Unsigned]/Bit String [16-bit]	In the case of a double word [unsigned]/bit string [32 bits] or a double word [signed] after conversion, an automatic conversion is made into to a value with a zero extension.*2 In the case of a single-precision real, an automatic conversion is made into the same value as the integer before the conversion.*1

*1 When the data of 16 bits (a word [signed] or a word [unsigned]/bit string [16 bits]) is transferred to an input argument of the data type ANY_REAL, an automatic conversion is made into a single-precision real.

*2 When the data of a word [unsigned]/bit string [16 bits] is transferred to an input argument of ANY32, an automatic conversion is made into a double word [unsigned]/bit string [32 bits].

For data types that are not described above, use the type conversion function.

Since type conversion is not performed in the following cases, use the type conversion function.

- Type conversion between integer-data types with different signs
- Type conversion between the data types by which the data is deleted

For the precautions for assigning the result of an arithmetic operation, refer to the following.

 Page 44 When an assigned arithmetic operation is used

Sub-program control statement

Function block call statement

Format	Description
Instance name(Input variable1:= Variable1, ... Output variable1: => Variable2, ...);	Enclose the assignment statement that assigns variables to the input variable and output variable by "(")" after the instance name. When using multiple variables, delimit the assignment statement by "," (comma).
Instance name.Input variable1:= Variable1; : Instance name(); Variable2:= Instance name.Output variable1;	List the assignment statement that assigns variables to the input variable and output variable before and after a function block call statement.

The following table shows the symbols used for arguments in a function block call statement and available formats.

Type	Description	Attribute	Symbol	Available formats
VAR_INPUT	Input variable	N/A, or RETAIN	:=	All formats
VAR_OUTPUT	Output variable	N/A, or RETAIN	=>	Variable only
VAR_IN_OUT	Input/Output variable	N/A	:=	All formats
VAR_PUBLIC	External variable	N/A, or RETAIN	Cannot be specified	—

The execution result of the function block is stored by assigning the output variable that is specified by adding "." (period) after the instance name to the variable.

Function block	FB definition	Example
Calling a function block with one input variable and one output variable	FB name: FBADD FB instance name: FBADD1 Input variable1: IN1 Output variable1: OUT1	FBADD1(IN1:=Input1); Output1:=FBADD1_OUT1;
Calling a function block with three input variables and two output variables	FB name: FBADD FB instance name: FBADD1 Input variable1: IN1 Input variable2: IN2 Input variable3: IN3 Output variable1: OUT1 Output variable2: OUT2	FBADD1(IN1:=Input1, IN2:=Input2, IN3:=Input3); Output1:=FBADD1_OUT1; Output2:=FBADD1_OUT2;

■Function call statement

Format	Description
Function name(Variable1, Variable2, ...);	Enclose an argument by "("" after the function name. When using multiple arguments, delimit them by "," (comma).

Assigning to variables stores the execution result of the function.

Function	Example
Calling a function with one input variable (Example: ABS)	<code>Outout1 := ABS(Input1);</code>
Calling a function with three input variables (Example: MAX)	<code>Outout1 := MAX(Input1, Input2, Input3);</code>
Calling a function with EN/ENO (excluding standard functions) (Example: MAX_E)	<code>Output1 := MAX_E(boolEN, boolENO, Input1, Input2, Input3);</code>
Calling a standard function (Example: MOV)	<code>boolENO := MOV(boolEN, Input1, Output1);</code> (The execution result of the function is ENO and the first argument (Variable1) is EN.)

A user-defined function that does not return a value and a function that includes a VAR_OUTPUT variable in the argument of a call statement can be executed as a statement by adding a semicolon (;) at the end.

■RETURN statement

Syntax	Format	Description	Example
■RETURN	RETURN;	The RETURN statement is used to end a program, function block, or function in the middle of processing. When the RETURN statement is used in a program, the processing jumps to the next step after the last line of the program. When the RETURN statement is used in a function block, the processing is returned from the function block. When the RETURN statement is used in a function, the processing is returned from the function. One pointer type label is used by the system for one RETURN statement.	<code>IF bool1 THEN RETURN; END_IF;</code>

A user-defined function that does not return a value and a function that includes a VAR_OUTPUT variable in the parameter of a call statement can be executed as a statement by adding a semicolon (;) at the end.

Conditional statement

Syntax	Format	Description	Example
■IF	IF <Boolean expression> THEN <Statement...> ; END_IF;	The statement is executed when the value of Boolean expression (conditional expression) is TRUE. The statement is not executed if the value of Boolean expression is FALSE. Any expression that returns TRUE or FALSE as the result of the Boolean operation with a single bit type variable status, or a complicated expression that includes many variables can be used for the Boolean expression.	<code>IF bool1 THEN intV1:=intV1+1; END_IF;</code>
■IF...ELSE	IF <Boolean expression> THEN <Statement 1...> ; ELSE <Statement 2...> ; END_IF;	Statement 1 is executed when the value of Boolean expression (conditional expression) is TRUE. Statement 2 is executed when the value of Boolean expression is FALSE.	<code>IF bool1 THEN intV3:=intV3+1; ELSE intV4:=intV4+1; END_IF;</code>
■IF...ELSIF	IF <Boolean expression 1> THEN <Statement 1...> ; ELSIF <Boolean expression 2> THEN <Statement 2...> ; ELSIF <Boolean expression 3> THEN <Statement 3...> ; END_IF;	Statement 1 is executed when the value of Boolean expression (conditional expression) 1 is TRUE. Statement 2 is executed when the value of Boolean expression 1 is FALSE and the value of Boolean expression 2 is TRUE. Statement 3 is executed when the value of Boolean expression 1 and 2 are FALSE and the value of Boolean expression 3 is TRUE.	<code>IF bool1 THEN intV1:=intV1+1; ELSIF bool2 THEN intV2:=intV2+2; ELSIF bool3 THEN intV3:=intV3+3; END_IF;</code>

Syntax	Format	Description	Example
■CASE	CASE <Integer expression> OF <Integer selection 1> : <Statement 1...> ; <Integer selection 2> : <Statement 2...> ; : <Integer selection n> : <Statement n...> ; ELSE <Statement n+1...> ; END_CASE;	When the statement that has the integer selection value that matches with the value of the integer expression (conditional expression) is executed, and if no integer selection value matches with the expression value, the statement that follows the ELSE statement is executed. The CASE statement is used to execute a conditional statement based on a single integer value or an integer value as the result of a complicated expression.	CASE intV1 OF 1: bool1:=TRUE; 2: bool2:=TRUE; ELSE intV1:=intV1+1; END_CASE;

Iteration statement

Syntax	Format	Description	Example
■FOR	FOR <Repeat variable initialization> TO <Last value> BY <Incremental expression> DO <Statement...> ; END_FOR;	The FOR...DO statement first initializes the data used as a repeat variable. An addition or subtraction is made to the initialized repeat variable according to the incremental expression. One or more statements from DO to END_FOR are repeatedly executed until the final value is exceeded. The repeat variable at the end of the FOR...DO syntax is the value at end of the execution.	FOR intV1:=0 TO 30 BY 1 DO intV3:=intV1+1; END_FOR;
■WHILE	WHILE <Boolean expression> DO <Statement...> ; END_WHILE;	The WHILE...DO statement executes one or more statements while the value of Boolean expression (conditional expression) is TRUE. The Boolean expression is evaluated before the execution of the statement. If the value of Boolean expression is FALSE, the statement in the WHILE...DO statement is not executed. Since a return result of the Boolean expression in the WHILE statement requires only TRUE or FALSE, any Boolean expression that can be specified in the IF conditional statement can be used.	WHILE intV1=30 DO intV1:=intV1+1; END_WHILE;
■REPEAT	REPEAT <Statement...> ; UNTIL <Boolean expression> END_REPEAT;	The REPEAT...UNTIL statement executes one or more statements while the value of Boolean expression (conditional expression) is FALSE. The Boolean expression is evaluated after the execution of the statement. If the value of Boolean expression is TRUE, the statement in the REPEAT...UNTIL statement are not executed. Since a return result of the Boolean expression in the REPEAT statement requires only TRUE or FALSE, any Boolean expression that can be specified in the IF conditional statement can be used.	REPEAT intV1:=intV1+1; UNTIL intV1=30 END_REPEAT;
■EXIT	EXIT;	The EXIT statement is used only in an iteration statement to end the iteration statement in the middle of processing. When the EXIT statement is reached during execution of the iteration loop, the iteration loop processing after the EXIT statement is not executed. The processing continues from the line after the one where the iteration statement is ended.	FOR intV1:=0 TO 10 BY 1 DO IF intV1>10 THEN EXIT; END_IF; END_FOR;

Precautions

■When an assignment statement is used

- The maximum number of character strings that can be assigned is 255. If 256 or more character strings are assigned, a conversion error occurs.
- Contacts and coils of the timer type or counter type cannot be used for the left side of an assignment statement.
- The instance of a function block cannot be used for the left side of an assignment statement. Use input variables, input/output variables, and external variables of the instance for the left side of an assignment statement.

■When an assigned arithmetic operation is used

When an arithmetic operation result is assigned to a variable of the larger data type, convert the variable of the arithmetic operation to the data type of the left side in advance and execute the operation.

Ex. When an arithmetic operation result of 16-bit data (INT type) is assigned to 32-bit data (DINT type)

```
varDint1 := varInt1 * 10;           // VarInt1 is a INT type variable, and varDint1 is a DINT type variable.
```

The arithmetic operation result is the same data type as that of the input operand. Thus, in the case of the above program, when the operation result of `varInt1 * 10` exceeds the range of the INT type (-32768 to +32767), an overflow or underflow result is assigned to `varDint1`.

In this case, convert the operand of the operational expression to the data type of the left side in advance and execute the operation.

```
varDint2 := INT_TO_DINT(varInt1); // INT type variable is converted to DINT type variable.
varDint2 := varDint2 * 10;       // DINT type multiplication is performed, and the operation result is assigned.
```

■Using the operator "-" for sign inversion in an arithmetic operation

When the operator "-" is used to invert the sign of the minimum value of a data type, the minimum value evaluates to the same value.

For example, `-(-32768)`, where the operator "-" is used with the minimum value of INT type, evaluates to -32768. Thus, an unintended result may be produced if the operator "-" is used to invert the sign of a variable whose data type will be automatically converted.

Ex. When the value of `varInt1` (INT type) is -32768, and the value of `varDint1` (DINT type) is 0.

```
varDint2 := -varInt1 + varDint1;
```

In the example above, the value of `(-varInt1)` evaluates to -32768 and -32768 is assigned to `varDint2`.

When using the operator "-" to invert the sign of a variable in an arithmetic operation, perform automatic conversion of the data type of the variable before the arithmetic operation. Alternatively, avoid using the operator "-" for sign inversion in the program.

Ex. Performing automatic conversion of the data type before an arithmetic operation

```
varDint3 := varInt;
varDint2 := -varDint3 + varDint1;
```

Ex. Avoiding the use of the operator "-" for sign inversion

```
varDint2 := varDint1 - varInt1;
```

■When a bit type label is used

Once the Boolean expression (conditional expression) is satisfied in a conditional statement or an iteration statement, the bit type label that is turned ON in <Statement> is always set to ON.

Ex. Program whose bit type label is always set to on

ST program	Ladder program equivalent to ST program
<pre>IF bLabel1 THEN bLabel2 := TRUE; END_IF;</pre>	

To avoid the bit device to be always set to ON, add a program to turn OFF the bit type label as shown below.

Ex. Program to avoid the bit type label to be always set to ON

ST program ^{*1}	Ladder program equivalent to ST program
<pre>IF bLabel1 THEN bLabel2 := TRUE; ELSE bLabel2 := FALSE; END_IF;</pre>	

*1 The above program can also be described as follows.

```
bLabel2 := bLabel1;
or
OUT(bLabel1,bLabel2);
```

However, when the OUT instruction is used in <Statement>, the program status becomes the same as the program whose bit type label is always set to on.

■When a timer function block or counter function block is used

Boolean expression (conditional expression) in a conditional statement differs for the execution conditions of the timer function block or counter function block.

Ex.

When a timer function block is used

■Program before change

```
IF bLabel1 THEN
  TIMER_100_FB_M_1(Coil:=bLabel2,Preset:=wLabel3,ValueIn:=wLabel4,ValueOut=>wLabel5,Status=>bLabel6);
END_IF;
(* When bLabel1 = on and bLabel2 = on, counting starts. *)
(* When bLabel1 = on and bLabel2 = off, the counted value is cleared. *)
(* When bLabel1 = off and bLabel2 = on, counting stops. The counted value is not cleared. *)
(* When bLabel1 = off and bLabel2 = off, counting stops. The counted value is not cleared. *)
```

■Program after change

```
TIMER_100_FB_M_1(Coil:=(bLabel1&bLabel2),Preset:=wLabel3,ValueIn:=wLabel4,ValueOut=>wLabel5,Status=>bLabel6);
```

When a counter function block is used

■Program before change

```
IF bLabel1 THEN
  COUNTER_FB_M_1(Coil:=bLabel2,Preset:=wLabel3,ValueIn:=wLabel4,ValueOut=>wLabel5,Status=>bLabel6);
END_IF;
(* When bLabel1 = on and bLabel2 = on/off, the value is incremented by 1. *)
(* When bLabel1 = off and bLabel2 = on/off, the value is not counted. *)
(* The counting operation does not depend on the on/off status of bLabel1. *)
```

■Program after change

```
COUNTER_FB_M_1(Coil:=(bLabel1&bLabel2),Preset:=wLabel3,ValueIn:=wLabel4,ValueOut=>wLabel5,Status=>bLabel6);
```

An error occurs when the program before change is used since the statement related to the timer or counter is not executed when the selection statement is not satisfied.

When the timer or counter is operated according to the AND condition of bLabel1 and bLabel2, do not use any control statement, just use a function block only.

Using the program after change operates the timer and counter.

■When the FOR...DO statement is used

- Structure members and array elements cannot be used as repeat variables.
- Match the type used for a repeat variable with the types of <Last value expression> and <Incremental expression>.
- <Incremental expression> can be omitted. When omitted, <Incremental expression> is treated as 1 and executed.
- When 0 is assigned to <Incremental expression>, the statements after the FOR syntax may not be executed or the processing goes into an infinite loop.
- In the FOR...DO syntax, the counting process of repeat variables is executed after the execution of <Statement...> in the FOR syntax. If the count is greater than the maximum value or smaller than the minimum value of the data type of the repeat variable, the processing goes into an infinite loop.

■When a rising execution instruction or a falling execution instruction is used

Shown here is the operation when a rising execution instruction or an fall execution instruction is used in an IF statement or a CASE statement.

Condition			Result of operation		
Conditional expression of an IF statement or a CASE statement	Condition to execute an instruction (EN)	Result of the ON/OFF judgment of the instruction at the time of the previous scan	Result of the ON/OFF judgment of the instruction	Rising execution instruction	Falling execution instruction
Agreement of TRUE or CASE	TRUE	ON	ON	Not executed	Not executed
		OFF	ON	Executed	Not executed
	FALSE	ON	OFF	Not executed	Executed
		OFF	OFF	Not executed	Not executed
Disagreement of FALSE or CASE	TRUE	ON	OFF	Not executed	Not executed* ¹
		OFF	OFF	Not executed	Not executed
	FALSE	ON	OFF	Not executed	Not executed* ¹
		OFF	OFF	Not executed	Not executed

*1 This is a fall (ON to OFF), but the instruction is not executed because the condition in the IF statement or the CASE statement is not satisfied.

Ex. When the PLS instruction (rising execution instruction) is used in an IF statement

```
IF bLabel0 THEN
  PLS(bLabel1,bLabel10);
END_IF;
```

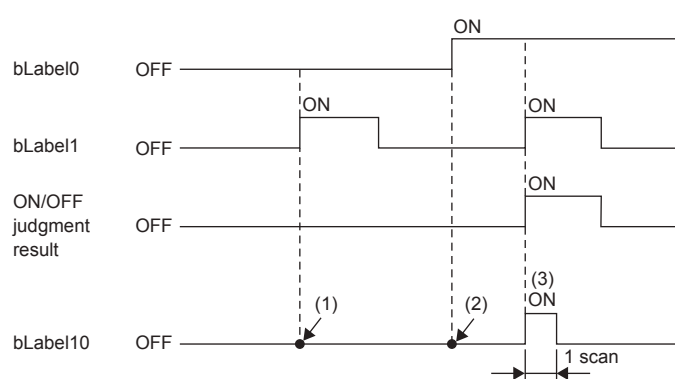

- (1) If bLabel0 = OFF (the condition expression in the IF statement is FALSE), the ON/OFF judgment result is OFF. The PLS instruction is not executed. (bLabel10 = OFF does not change.)
- (2) If bLabel0 = ON (the condition expression in the IF statement is TRUE) and bLabel1 = OFF (the condition for executing the instruction is OFF), the ON/OFF judgment result is OFF. The PLS instruction is not executed. (bLabel10 = OFF does not change.)
- (3) If bLabel0 = ON (the condition expression in the IF statement is TRUE) and bLabel1 = ON (the condition for executing the instruction is ON), the ON/OFF judgment result is OFF to ON (the condition for a rise is satisfied). The PLS instruction is executed. (bLabel10 turns ON for once scan only.)

■When a master control instruction is used

Shown here is the operation when the master control is OFF.

- The statement in a selection statement (an IF statement or a CASE statement) or in a iteration statement (a FOR statement, a WHILE statement, or a REPEAT statement) is not processed.
- Outside of a selection statement or a iteration statement, assignment statement is not processed and statement other than assignment statement is not executed.

Ex. A statement in a selection statement (IF statement)

```
MC(M0,N1,M1); //Master control OFF
IF M2 THEN
    M3:=M4;      //No processing is executed when the master control is OFF. So, M3 maintains the value at the time of a previous scan.
END_IF;
M20:=MCR(M0,N1);
```

Ex. A statement out of a selection statement or a iteration statement (in the case of a bit assignment statement)

```
MC(M0,N1,M1); //Master control OFF
M3:=M4;      //No processing is executed when the master control is OFF. So, M3 maintains the value at the time of a previous scan.
M20:=MCR(M0,N1);
```

Ex. A statement out of a selection statement or a iteration statement (in the case of an OUT instruction)

```
MC(M0,N1,M1); //Master control OFF
OUT(M2,M3);    //No execution is made when the master control is OFF.
M20:=MCR(M0,N1);
```

Constant

Methods for expressing constants

The following table shows the expression methods for setting a constant in a ST program.

Data type		Expressing method	Example
String(32)	STRING	Enclose character strings with single quotation (').	Stest := 'ABC';

For the expression methods other than the one described the above, refer to the following.

 Page 30 Constant

Label and device

Specification method

Labels and devices can be directly described in the ST program. Labels and devices can be used for the left or right side of an expression or as an argument or return value of a standard function/function block.

For available labels, refer to the following.

 Page 22 LABELS

For available devices, refer to the following.

 User's manual (Application)

■Device expression with type specification

A word device can be used in ST language as an arbitrary data type by adding a device type specifier to its name.

Device type specifier	Data type	Example	Description
N/A	Generic data type ANY16. When only devices are used in arithmetic operations, the data type is Word [signed]. However, when the data is specified as a device without the type specification in the argument part of FUN/FB, the data type is the one of the argument definition.	D0	When no type specifier is added to D0
:U	Word [Unsigned]/Bit String [16-bit]	D0:U	The value when D0 is Word [unsigned]/Bit string [16-bit]
:D	Double Word [Signed]	D0:D	The value when D0 and D1 are Double word [signed]
:UD	Double Word [Unsigned]/Bit String [32-bit]	D0:UD	The value when D0 and D1 are Double word [unsigned]/Bit string [32-bit]

Device type specifier	Data type	Example	Description
:E	FLOAT (Single Precision)	D0:E	The value when D0 and D1 are single-precision real numbers

The following shows the devices to which device type specifiers can be added.

- Data register (D)
- Link register (W)
- Module access device (U□\G□)
- File register (R)

■ Device specification method

The following methods can be used for specifying a device.

- Indexing
- Bit specification
- Nibble specification
- Indirect specification

For details, refer to the following.

📖 User's manual (Application)

📖 Programming manual (Instructions, Standard Functions/Function Blocks)

Precautions

- The pointer type can be used for ST programs.
- When a value is assigned using nibble specification, use the same data type for the left side and right side of an operation.

Ex. D0 := K5X0;

In the above case, since K5X0 is the double word type and D0 is the word type, an error occurs in the program.

- When a value is assigned using nibble specification and the data size of the right side is larger than that of the left side, data is transmitted within the range of the target points of the left side.

Ex. K5X0 := 2#1011_1101_1111_0111_0011_0001;

In the above case, since the target points of K5X0 is 20, 1101_1111_0111_0011_0001 (20 bits) are assigned to K5X0.

- When the current value (such as TNn) of a counter (C), timer (T), or retentive timer (ST) is used with a type other than Word [unsigned]/Bit string [16-bit], or when the current value (such as LCNn) of a long counter (LC) is used with a type other than Double word [unsigned]/Bit string [32-bit], use the type conversion function.

Ex. varInt := WORD_TO_INT(TN0); (*Use the type conversion function*)

Comment

The following table shows the comment formats that can be used in a ST program.

Comment format	Comment symbol	Description	Example
Single line comment	//	The character strings between the start symbol "//" and the end of the line are used as a comment.	// Comment
Multiple-line comment	(* *)	The character strings between the start symbol "(" and the end symbol ")" are used as a comment. Newlines can be inserted in the comment.	<ul style="list-style-type: none"> ■ Without newline (* Comment *) ■ With newline (* Comment in the first line Comment in the second line *)
	/* */	The character strings between the start symbol "/*" and the end symbol "*/" are used as a comment. Newlines can be inserted in the comment.	<ul style="list-style-type: none"> ■ Without newline /* Comment */ ■ With newline /* Comment in the first line Comment in the second line */

When the multiple-line comment format is used, do not use end symbols inside comments.

7 FBD/LD language

This is a language that creates a program by wiring blocks for specific processing, variables, and constants along with the flows of data and signals.

7.1 Configuration

With the FBD/LD language, the following program can be created.

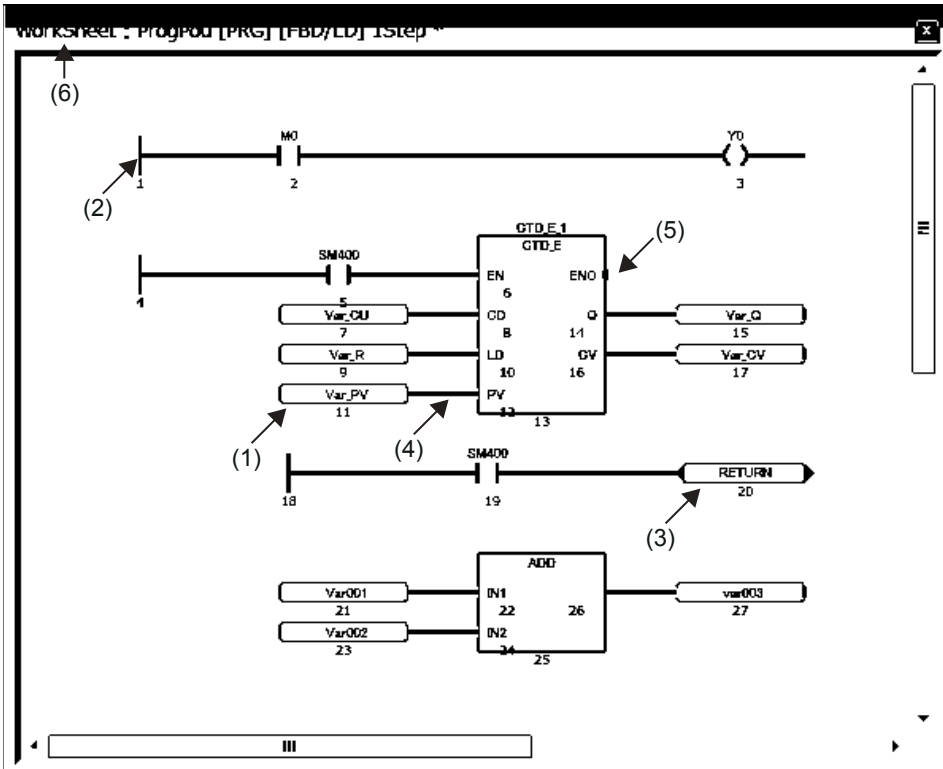

- (1) FBD unit
- (2) LD unit
- (3) Common unit
- (4) Connecting wire
- (5) Connecting point
- (6) Worksheet

In a program of the FBD/LD language, data flows from the output point of a function block (FB), a function (FUN), a variable unit (label or device), and constant unit to the input point of another function block, variable unit, and so forth.

Program unit

FBD unit

Units constituting FBD/LD program are shown below.

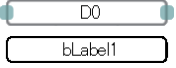
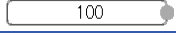
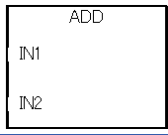
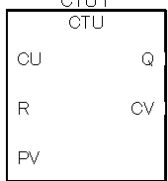
Unit	Symbol	Description
Variable		A variable is used to store each value (data). The data type of a variable should be a certain type. Only the value (data) of the data type is stored. You can specify a label or a device to a variable.
Constant		The constant specified is output.
Function (FUN)		Executes a function. <ul style="list-style-type: none"> • How to create functions (GX Works3 Operating Manual) • Standard function (MELSEC iQ-F FX5 Programming Manual (Instructions, Standard Functions/Function Blocks))
Function Block (FB)		Executes a function block. <ul style="list-style-type: none"> • How to create function blocks (GX Works3 Operating Manual) • Standard function blocks (MELSEC iQ-F FX5 Programming Manual (Instructions, Standard Functions/Function Blocks)) • Module function blocks (MELSEC iQ-F FX5 CPU Module Function Block Reference)

■The data type of a constant unit

In the case of a constant unit, the data type of the constant value is not determined at the time when the constant value is input. The data type is determined when the constant unit and an FBD unit are connected over a connecting wire. The data type of the constant value is the same data type as the FBD unit at the destination of the connecting wire.

Ex. When 1 is input as a constant value

The data type can be a BOOL type, a WORD type, a DWORD type, an INT type, a DINT type, or a REAL type. So, the data type is not determined. When the constant unit and an FBD unit are connected over a connecting wire, the data type becomes the data type at the input point of the unit at the destination of the connection.

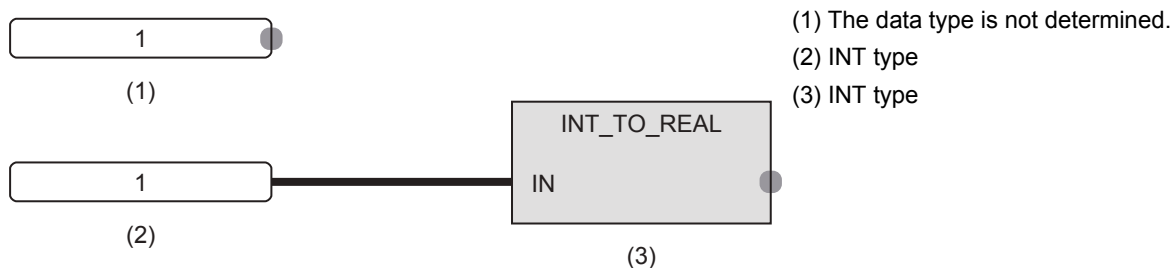

■Automatic conversion of data types

The data type of an element may be automatically converted when it is connected to another element of a different data type. To avoid the deletion of the data during the type conversion, only conversion from smaller type to larger type is performed. Automatic conversion of data type in the FBD/LD language behaves in the same way as that in the ST language. For details, refer to the following.

☞ Page 40 Automatic conversion of data types

■The input/output point of a function

- It is necessary that all the input points of a function should be connected to other FBD units over connecting wires.
- The data types of the input variables and output variables of a function should be of certain types. It is necessary that the FBD units to be connected to the input point or output point should be of the same data types.
- Connect a variable element between an output variable (except for ENO) of a CPU module instruction or module dedicated instruction and an input variable of another function (or function block).
- In a program that connects a function with EN to another function over a connecting wire, the other function must be a function with EN and the program must connect ENO and EN over a connecting wire, in order to prevent the function from using an indefinite value.

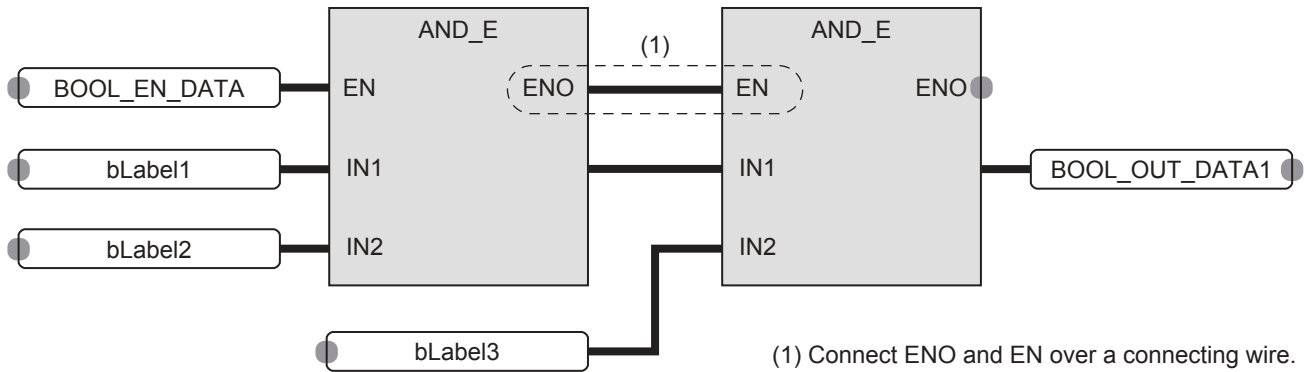

LD unit

Units of ladder diagram that can be used in a program of the FBD/LD language are shown below.

Unit	Symbol	Description
Left bus		This is an unit to represent a bus. This is the starting point to create a ladder circuit.
NO contact		Turns on when a specified device or label is ON.
NC contact		Turns on when a specified device or label is OFF.
Rising edge		Turns on at the rising edge (OFF to ON) of a specified device or label.
Falling edge		Turns on at the falling edge (ON to OFF) of a specified device or label.
Negated rising edge		Turns on when a specified device or label is OFF or ON, or at the falling edge (ON to OFF) of a specified device or label.
Negated falling edge		Turns on when a specified device or label is OFF or ON, or at the rising edge (OFF to ON) of a specified device or label.
Coil		Outputs an operation result to a specified device or a label.
Complementing coil		When the operation result turns OFF, the specified device or label turns ON.
Set		When the operation result turns ON, the specified device or label turns ON. The device or the label that turns ON remains ON even if the operation result turns OFF.
Reset		When the operation result turns ON, the specified device or label turns OFF. When the operation result is OFF, the status of the device or the label does not change.

■The AND operation and OR operation of a contact symbol

A contact symbol executes an AND operation or an OR operation depending on the status of the connection of a circuit chart. This is reflected in the operation result.

- In the case of a series connection (1), an AND operation is executed with the operation results so far. This will be the operation result.
- In the case of a parallel connection (2), an OR operation is executed with the operation results so far. This will be the operation result.

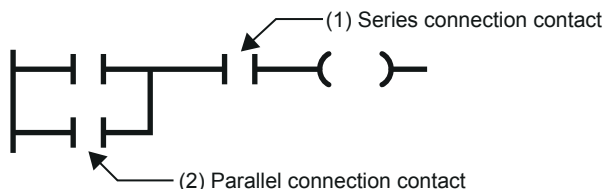

Common unit

This represents a common unit placed on the FBD/LD editor.

Unit	Symbol	Description
Jump		The execution processing is jumped over from a jump unit to a jump label. The portion that is jumped over is not executed. Whether a jump is made or not is controlled depending on the ON/OFF information to the jump unit. ON: The execution processing is jumped over up to a jump label. OFF: The execution processing is not jumped over but is executed.
Jump label		This is the destination of a jump from a jump instruction in the same program. The processing is executed from a program in the execution order after the jump label.
Connector		This is used as a substitute of a connecting wire. The processing moves on to the corresponding connector unit. You can use one input connector or multiple input connectors for one output connector.
Return		The processing after a return unit in the program is aborted. Use this when you want to prohibit the execution of the processing of a program, function, or a function block after the return unit. Whether the return processing is executed or not is controlled depending on the ON/OFF information to the return unit. ON: The return processing is executed. OFF: The return processing is not executed, but the ordinary execution processing is executed.
Comment		Use this to describe a comment.

■Precautions for a jump unit

- If the timer of a coil that is ON is jumped over by using a jump unit, a normal measurement cannot be conducted.
- You can add a jump label on the top side (the execution is earlier) of a jump unit. In this case, create the program by including a method to break the loop in order not to exceed the setting value of the watchdog timer.
- You can specify only a local label of a pointer type for a jump element and jump label. Pointer devices cannot be used.
- The pointer branch instruction (CJ) cannot be used. For jumping, use jump elements.
- Jumps to or from outside the program block cannot be executed. The following is a list of jump operations that cannot be executed.
 - Jumping to outside the program block ^{*1}
 - Jumping from outside the program block ^{*1}
 - Calling subroutine programs
 - Called as subroutine programs

*1 Includes branches caused by the BREAK instruction.

■The operation of a return unit

A return unit operates differently depending on whether a program, function, and/or function block used there.

Program unit to use	
Program	The execution of the program unit is terminated.
Function	The function is terminated, and the step goes back to the one next to the instruction that has called the function.
Function block	The function block is terminated, and the step goes back to the one next to the instruction that has called the function block.

If a return element is used in a macro-type function block, do not place two or more function block elements of the same instance name.

A local label "_SYSTEM_RETURN" is automatically registered when a program using a return element is converted.

The local label "_SYSTEM_RETURN" has the following operational limitations:

Operation on the label automatically registered	Permitted/Prohibited
Changing the label name	Prohibited*1
Changing the data type	Prohibited
Changing the class	Prohibited
Deleting the label	Prohibited*1
Changing the line of registration	Permitted

*1 If the program is converted again after change or deletion, a new local label is registered.

■Connector unit

Use a connector element to place the program within the display area or print area of the FBD/LD editor.

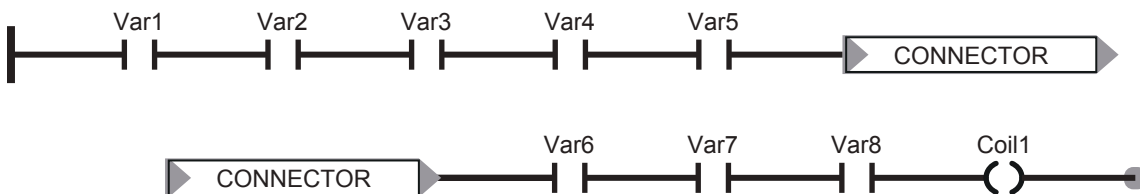

Connecting wire

This is the wire to connect the connecting points between FBD unit, LD unit, and common unit.

After units are connected, the data is transferred from the left end to the right end. The data types of the connected units need to be the same.

Connecting point

This is a terminal point to use a connecting wire to connect FBD unit, LD unit, and common unit.

The point on the left side of each unit is the input side, while the point on the right side represents the output side.

Unit	Input connecting point	Output connecting point	Unit	Input connecting point	Output connecting point
Contact			Coil		
Variable			Constant		
Function			Function Block		

The connecting point is hidden after connecting a wire.

■ Inverting input and output points

You can invert an input to an unit or an output from an unit by using a connecting point.

The connecting point having been inverted is circled with a black circle. The data to be input or output is inverted (FALSE to TRUE or TRUE to FALSE).

You can invert the following data types: BOOL, WORD, DWORD, ANY_BIT, and ANY_BOOL.

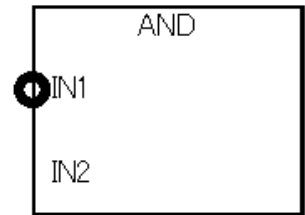

Worksheet

A worksheet is a work area for inserting program units and for connecting them with wires.

Constant

Methods for expressing constants

The following table shows the expression methods for setting a constant in FBD/LD language.

Data type		Expressing method	Example
String(32)	STRING	Enclose character strings with single quotation (').	<input type="text" value="'ABC'"/>

For the expression methods other than the one described the above, refer to the following.

📖 Page 30 Constant

Labels and devices

Specification method

You can directly describe and use labels and devices in an FBD/LD program. You can use labels and devices for inputs and output points of units, for arguments of standard functions/function blocks, return values, and so forth.

For available labels, refer to the following.

📖 Page 22 LABELS

For available devices, refer to the following.

📖 User's manual (Application)

■ Device expression with type specification

A word device can be used as any data by adding a device type specifier to its name. If you do not specify a data type, the word device operates as a word [signed] (INT).

For the device type specifiers and the devices you can use, refer to the following.

📖 Page 47 Device expression with type specification

If you do not specify a data type for a word device, the data type is determined by the type of device.

Word device	Data type
The current value of a timer device (TN), the current value of a retentive timer device (STN), the current value of a counter device (CN)	WORD
The current value of a long counter device (LCN)	DWORD
Other than the above	INT

Caution

■ When using label

- Labels whose name ends with "_" cannot be used as an array index. To use such a device or label as an array index, assign it to another device or label and specify that device or label as an index.
- Members of labels (structures or function blocks) whose name ends with "_" cannot be specified.
- Indexes cannot be specified to labels (arrays) whose name ends with "_".

7.2 Program execution order

The order of executions of program units

The order of executions of the units in the FBD/LD editor is determined depending on the positional relation of the units and on the status of connecting wires.

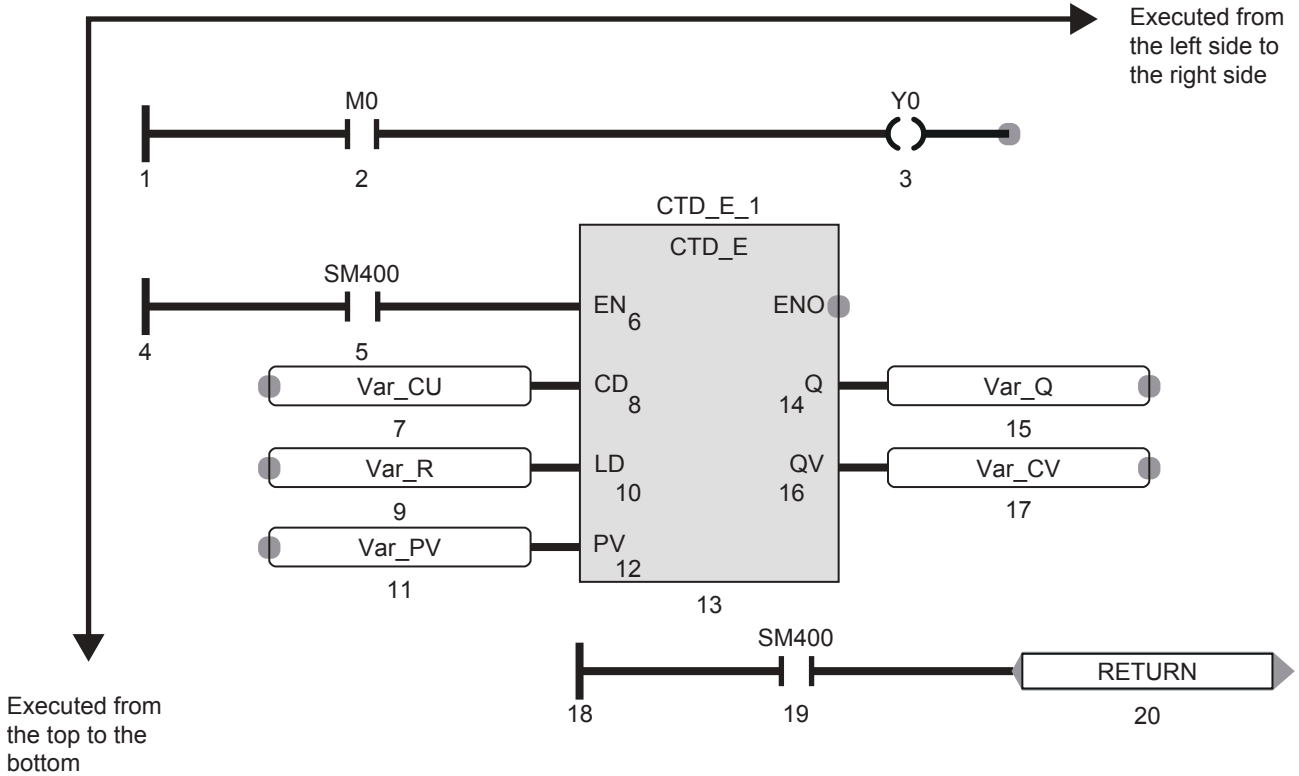

The number of the order of the execution is shown on each unit placed on the FBD/LD editor.

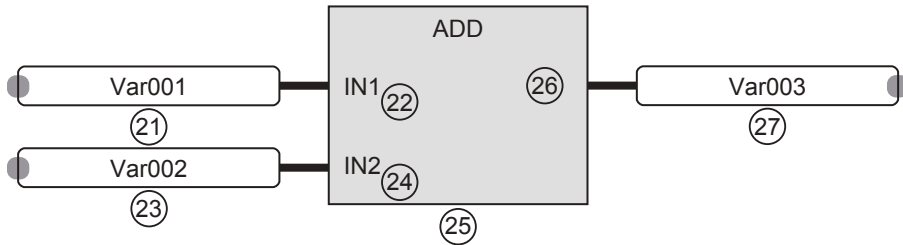

INDEX

Symbols

-	39
*	39
**	39
/	39
&	39
+	39
<	39
<=	39
<>	39
=	39
>	39
>=	39
\$	30

A

AND	39
Arrays of structures	29
Assignment statement	40

B

Bit	23
BOOL	23

C

CASE	43
Class	23,25
Common unit	49,52
Connecting point	49,53
Connecting wire	49,53
Constant	30
Constant unit	50
COUNTER	24
Counter	24

D

Data type	23,24,25
Device assignment	22
DINT	23
Double Word [Signed]	23
Double Word [Unsigned]/Bit String [32-bit]	23
DWORD	23

E

EN	13,18
ENO	13,18
EXIT	43
External variable	17

F

FB/FUN file	13,14,18,19
FBD unit	49,50
FBD/LD language	7,49
FLOAT [Single Precision]	23
FOR	43

FOR...DO	46
Function (FUN)	11,12
Function Block (FB)	11,16
Function block call statement	41
Function call statement	42

G

Generic data type (ANY)	25
Global label	23,25
Global labels	22

I

IF	42
IF ...ELSE	42
IF ...ELSIF	42
Input variable	12,16
Input/output variable	16
Instances	17
INT	23
Internal variable	17
Interrupt program	10

L

Ladder diagram	7,33
LCOUNTER	24
LD unit	49,51
Local label	22,23,25
Long Counter	24

M

Macro type function blocks	19
Main routine program	10
MOD	39
Module labels	22

N

NOT	39
Notes	36
Number of array elements	27
Number of steps	14

O

OR	39
Output variable	12,16

P

POINTER	24
Pointer	24
Program	9,13,18
Program block	10
Program file	9
Programming languages	7
Project	9

R

REAL	23
REPEAT	43
Reserved word	38
Retentive Timer	24
RETENTIVETIMER	24
RETURN	42

S

ST language	7,37
Statements	36
STRING	24,47,54
String	24,47,54
Structures	24,28
Subroutine program	10
Subroutine type function blocks	19,20
System labels	22

T

TIME	24
Time	24
TIMER	24
Timer	24
Type conversion	40
Type specification	47

W

WHILE	43
WORD	23
Word [Signed]	23
Word [Unsigned]/Bit String [16-bit]	23
Worksheet	49,54

X

XOR	39
---------------	----



REVISIONS

Revision date	Revision	Description
October 2014	A	First Edition
January 2015	B	■Added functions FBD/LD language ■Added or modified parts Chapter 1, Section 3.1, 3.2, 4.1, 4.3, 4.4, 4.5, 5.2, 5.3, Chapter 6, 7
April 2015	C	A part of the cover design is changed.

This manual confers no industrial property rights or any rights of any other kind, nor does it confer any patent licenses. Mitsubishi Electric Corporation cannot be held responsible for any problems involving industrial property rights which may occur as a result of using the contents noted in this manual.

© 2014 MITSUBISHI ELECTRIC CORPORATION

WARRANTY

Please confirm the following product warranty details before using this product.

1. Gratis Warranty Term and Gratis Warranty Range

If any faults or defects (hereinafter "Failure") found to be the responsibility of Mitsubishi occurs during use of the product within the gratis warranty term, the product shall be repaired at no cost via the sales representative or Mitsubishi Service Company. However, if repairs are required onsite at domestic or overseas location, expenses to send an engineer will be solely at the customer's discretion. Mitsubishi shall not be held responsible for any re-commissioning, maintenance, or testing on-site that involves replacement of the failed module.

[Gratis Warranty Term]

The gratis warranty term of the product shall be for one year after the date of purchase or delivery to a designated place. Note that after manufacture and shipment from Mitsubishi, the maximum distribution period shall be six (6) months, and the longest gratis warranty term after manufacturing shall be eighteen (18) months. The gratis warranty term of repair parts shall not exceed the gratis warranty term before repairs.

[Gratis Warranty Range]

- 1) The range shall be limited to normal use within the usage state, usage methods and usage environment, etc., which follow the conditions and precautions, etc., given in the instruction manual, user's manual and caution labels on the product.
- 2) Even within the gratis warranty term, repairs shall be charged for in the following cases.
 - a) Failure occurring from inappropriate storage or handling, carelessness or negligence by the user. Failure caused by the user's hardware or software design.
 - b) Failure caused by unapproved modifications, etc., to the product by the user.
 - c) When the Mitsubishi product is assembled into a user's device, Failure that could have been avoided if functions or structures, judged as necessary in the legal safety measures the user's device is subject to or as necessary by industry standards, had been provided.
 - d) Failure that could have been avoided if consumable parts (battery, backlight, fuse, etc.) designated in the instruction manual had been correctly serviced or replaced.
 - e) Relay failure or output contact failure caused by usage beyond the specified life of contact (cycles).
 - f) Failure caused by external irresistible forces such as fires or abnormal voltages, and failure caused by force majeure such as earthquakes, lightning, wind and water damage.
 - g) Failure caused by reasons unpredictable by scientific technology standards at time of shipment from Mitsubishi.
 - h) Any other failure found not to be the responsibility of Mitsubishi or that admitted not to be so by the user.

2. Onerous repair term after discontinuation of production

- 1) Mitsubishi shall accept onerous product repairs for seven (7) years after production of the product is discontinued.
Discontinuation of production shall be notified with Mitsubishi Technical Bulletins, etc.
- 2) Product supply (including repair parts) is not available after production is discontinued.

3. Overseas service

Overseas, repairs shall be accepted by Mitsubishi's local overseas FA Center. Note that the repair conditions at each FA Center may differ.

4. Exclusion of loss in opportunity and secondary loss from warranty liability

Regardless of the gratis warranty term, Mitsubishi shall not be liable for compensation of damages caused by any cause found not to be the responsibility of Mitsubishi, loss in opportunity, lost profits incurred to the user or third person by failure of Mitsubishi products, special damages and secondary damages whether foreseeable or not, compensation for accidents, and compensation for damages to products other than Mitsubishi products, replacement by the user, maintenance of on-site equipment, start-up test run and other tasks.

5. Changes in product specifications

The specifications given in the catalogs, manuals or technical documents are subject to change without prior notice.

6. Product application

- 1) In using the Mitsubishi MELSEC programmable controller, the usage conditions shall be that the application will not lead to a major accident even if any problem or fault should occur in the programmable controller device, and that backup and fail-safe functions are systematically provided outside of the device for any problem or fault.
- 2) The Mitsubishi programmable controller has been designed and manufactured for applications in general industries, etc. Thus, applications in which the public could be affected such as in nuclear power plants and other power plants operated by respective power companies, and applications in which a special quality assurance system is required, such as for railway companies or public service purposes shall be excluded from the programmable controller applications.
In addition, applications in which human life or property that could be greatly affected, such as in aircraft, medical applications, incineration and fuel devices, manned transportation, equipment for recreation and amusement, and safety devices, shall also be excluded from the programmable controller range of applications.
However, in certain cases, some applications may be possible, providing the user consults their local Mitsubishi representative outlining the special requirements of the project, and providing that all parties concerned agree to the special circumstances, solely at the user's discretion.

TRADEMARKS

Microsoft® and Windows® are either registered trademarks or trademarks of Microsoft Corporation in the United States and/or other countries.

Ethernet is a trademark of Xerox Corporation.

MODBUS® is a registered trademark of Schneider Electric SA.

The company name and the product name to be described in this manual are the registered trademarks or trademarks of each company.

Manual number: JY997D55701C

Model: FX5-P-PS-E

Model code: 09R538

When exported from Japan, this manual does not require application to the Ministry of Economy, Trade and Industry for service transaction permission.

MITSUBISHI ELECTRIC CORPORATION

HEAD OFFICE: TOKYO BUILDING, 2-7-3 MARUNOUCHI, CHIYODA-KU, TOKYO 100-8310, JAPAN

Specifications are subject to change without notice.