

FP2500-T11 FP2600-T11

Installation Guide



WARNINGS

- When connecting the FP2500-T11/FP2600-T11 (hereafter referred to as the "FP")'s power cord terminals to the FP Terminal Block, check first that the FP's power supply is completely turned OFF, via a breaker, or similar unit.
- Whenever changing the backlight, to prevent electric shocks and burns, be sure to unplug the FP's power cord and wear protective gloves.
- Do not open or remodel the FP unit, since it may lead to a fire or electric shock.
- Do not use power beyond the FP's specified voltage range. Doing so may cause a fire or an electric shock.
- Do not use the FP in an environment where flammable gases are present, since operating the FP may cause an explosion.
- The FP uses a lithium battery for backing up its internal clock data. If the battery is incorrectly replaced (i.e. its + and — sides are reversed), the battery may explode. When changing the battery, please contact your local FP distributor.
- Do not use the FP unit as a warning device for critical alarms that can cause serious operator injury, machine damage or production stoppage. Critical alarm indicators and their control/activator units must be designed using stand-alone hardware and/or mechanical interlocks.
- Do not use FP touch panel switches in life-related or important disaster prevention situations. For safety related switches, such as an emergency switch, be sure to use a separate mechanical switch.
- To prevent operator injury or machine damage, be sure to design your machine operation system so that the machine will not malfunction due to a communication fault between the FP and its host controller.
- The FP is not appropriate for use with aircraft control devices, aerospace equipment, central trunk data transmission (communication) devices, nuclear power control devices, or medical life support equipment, due to these devices' inherent requirements of extremely high levels of safety and reliability.
- When using the FP with transportation vehicles (trains, cars and ships), disaster and crime prevention devices, various types of safety equipment, non-life support related medical devices, etc. Redundant and/or failsafe system designs should be used to ensure the proper degree of reliability and safety.



CAUTIONS

- Do not strike the FP touch panel with a hard or heavy object, or press on the touch panel with too much force, since it may damage the display.
- Do not install the FP where the temperature will exceed its specified range.
- Be sure that water, liquids or metal particles do not enter the FP, since it may cause a malfunction or a short circuit.
- Avoid installing the FP where sudden, large changes in temperature may occur. These changes may cause condensation to form inside the unit, possibly causing a malfunction.
- To prevent excessive heat from building up inside the FP, do not install it where its ventilation holes may be blocked. Also, do not install or store the FP near high tem-

Industrial automation

Elincom Group

 European Union: www.elinco.eu

 Russia: www.elinc.ru

Package Contents

The following items are included in the FP's package. Before using the FP, please confirm that all items listed here are present.

■ **FP unit**

(FP2500-T11 / FP2600-T11)

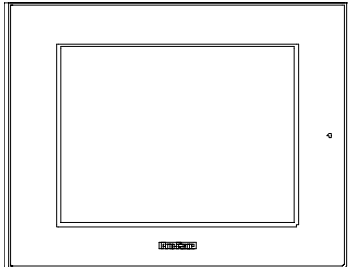

■ **CD-ROM(1)**

Contains FP2500-T11/FP2600-T11

User Manual



■ **Installation Gasket (1)**



■ **Installation Brackets (4)**

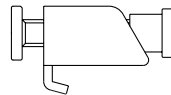

■ **3.5 inch floppy disk(1)**

(Contains Touch Panel programs)
(Only FP2500-T11)

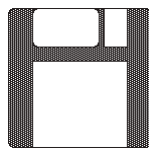

■ **FP2500-T11/FP2600-T11**

Installation Guide (1)
(this manual)

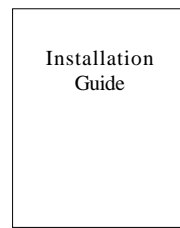

This unit has been carefully packed, with special attention to quality. However, should you find anything damaged or missing, please contact your local FP distributor immediately.

Options

- **Cables**
- **Touch panel driver software**
- **Maintenance Parts**

1 Part Names

Front View

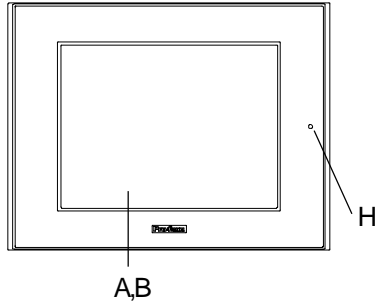

- A: **TFT Color LCD**
The display monitor for your host.
- B: **Touch Panel**
Allows you to perform touch operation.
- C: **Power Input Terminal Block**
Provides the input and ground terminals for a power cable.
- D: **Setting Switch (Dip switch)**
- E: **VGA Interface (analog RGB) Connector**

Rear View

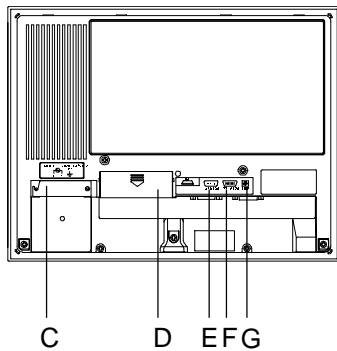

- F: **Serial Interface Connector**
Used for both sending touch panel data to the host, and receiving commands from the host.
- G: **USB Interface Connector**
Used for both sending touch panel data to the host, and receiving commands from the host.
- H: **Front LED**
An LED to detect power supply, backlight burning out and input of image signal.

2 Dimensions

Unit:mm [in]

Top View
(FP2500-T11/FP2600-T11)

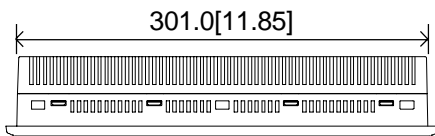

Side View
(FP2500-T11
/FP2600-T11)

Front View (FP2500-T11)

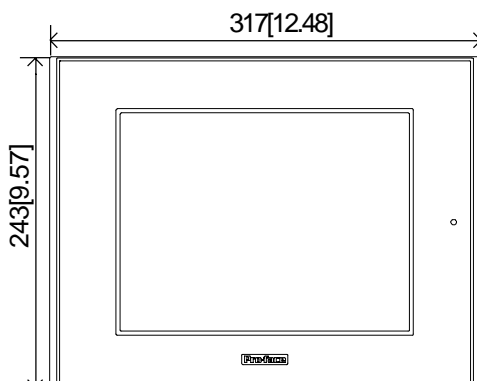

Front View (FP2600-T11)

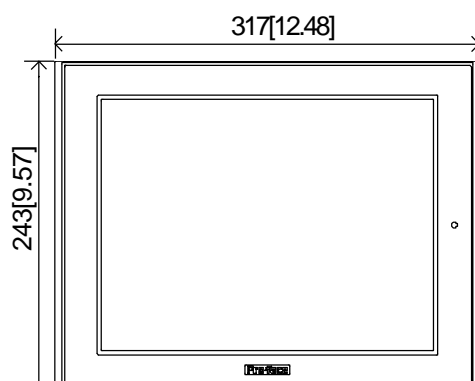

3 Dip Switches

Dip switch is under the cover that shows in picture below.

FP2500-T11
/FP2600-T11
(rear view)

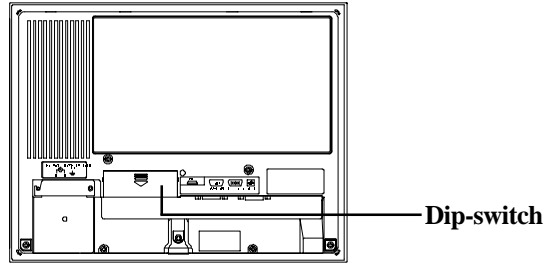

The default settings for the FP were created based on the standard connection method used with IBM-PCs.

Use these dip switches to control the FP unit's display features. If it does not display images properly with the standard settings shown below, please adjust the switches.

If Dip Switch needs change of Dip Switch setting, please reboot the power of FP again.

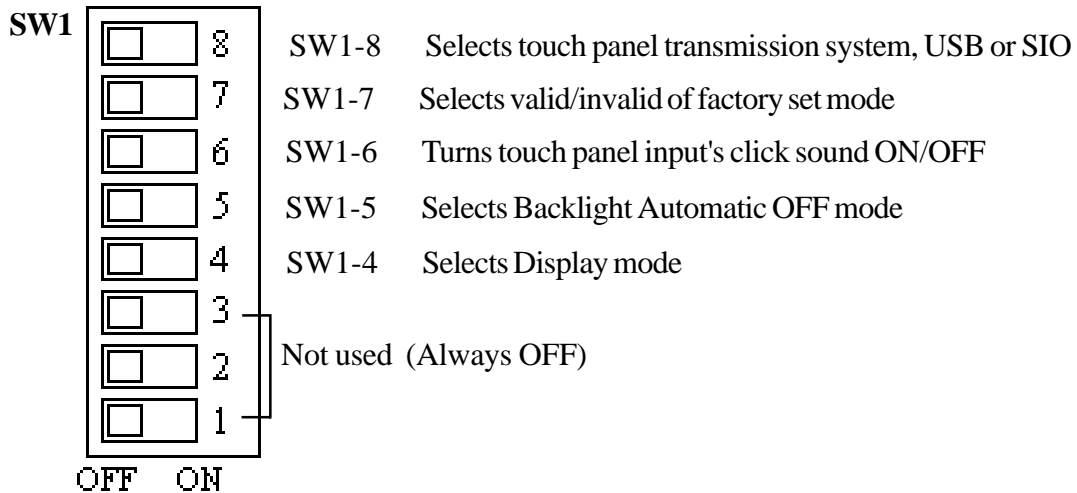

• SW1-4

This switch is used to designate the FP's display mode.

SW1-4	Display Mode
OFF	VGA Graphics & text mode
ON	VGA Graphics mode

For more details, refer to 4.'Analog RGB Interface'.

You can't use this switch on FP2600-T11.

Please set this switch OFF when the FP2600-T11 unit is used.

• SW1-5

This switch controls the Automatic Backlight OFF mode.

When this switch is ON, and if there is no SIO transmission or touch operation performed for 5 minutes, the backlight turns off automatically. It will remain OFF until another SIO transmission or touch operation takes place, at which time the backlight automatically turns back on.

If the FP unit is frequently not used, please set this switch ON to extend the life of the backlight. Also, if a display related command is transmitted by the SIO, this Automatic Backlight OFF mode will be automatically disabled.

• SW1-6

This controls is used as the touch screen Click sound's ON/OFF switch.

When this is set to ON, a click will sound every time the touch panel is touched.

• SW1-7

This is a switch to shift as adjustment mode at factory.

Please set this switch OFF when the FP unit is used.

• SW1-8

This is a switch to change the data input (command control) of the touch panel.

Data output and command input/output will be performed from the USB connector when this is ON condition and from RS232C connector when it is OFF.

4 Interfaces

Analog RGB Interface

Input signal type	Analog RGB
Input signal characteristic	Image signal: analog RGB Synchronous signal: TTL level, negative true or positive true Scanning type: non-interlace
Setting by OSD (On Screen Display)	Contrast Adjustment Sub Contrast Adjustment Brightness Adjustment Horizontal Display Position Adjustment Vertical Display Position Adjustment Horizontal Adjustment Phase Adjustment Dimmer Adjustment Default Setting (All Clear Function)

(FP2500-T11)

Size	H Sync.	V Sync.	Dot Clock Range
640 x 480	31.469±1 KHz	60±1 Hz	25.175MHz±1%
640 x 400	24.827±1 KHz	56±1 Hz	21.053MHz±1%
640 x 400	31.469±1 KHz	70±1 Hz	25.175MHz±1%
640 x 350	31.469±1 KHz	70±1 Hz	25.175MHz±1%
720 x 400	31.469±1 KHz	70±1 Hz	28.322MHz±1%
720 x 350	31.469±1 KHz	70±1 Hz	28.322MHz±1%



- Changeover from horizontal 720 pixels to 640 pixels is done via DIP switch.
- When the horizontal 720 pixel signal is input;
 - VGA Graphic & Text mode displays 640 pixels only and 80 pixels are not displayed.
 - VGA Graphic mode displays all pixels but images may be cut off if they do not match the sampling .
- With vertical 350 pixels, 400 pixels, including 50 pixels at the top and at the bottom of the screen will be enlarged and displayed at 480 pixels (1.2 times).
- In VGA Graphic & text mode, the far right side's 80 pixels do not display.
- Selection of display mode is done via switch SW1-4.

(FP2600-T11)

Size	H Sync.	V Sync.	Dot Clock Range
800 x 600	35.156±1 KHz	56±1 Hz	36.000MHz±1%
800 x 600	37.879±1 KHz	60±1 Hz	40.000MHz±1%
640 x 480	31.469±1 KHz	60±1 Hz	25.175MHz±1%
640 x 480	35.000±1 KHz	66±1 Hz	30.240MHz±1%
640 x 480	37.861±1 KHz	72±1 Hz	31.500MHz±1%
640 x 400	24.827±1 KHz	56±1 Hz	21.053MHz±1%
640 x 400	31.469±1 KHz	70±1 Hz	25.175MHz±1%
640 x 350	31.469±1 KHz	70±1 Hz	25.175MHz±1%
720 x 400	31.469±1 KHz	70±1 Hz	28.322MHz±1%
720 x 350	31.469±1 KHz	70±1 Hz	28.322MHz±1%



- With vertical 350 pixels, 400 pixels, including 50 pixels at the top and at the bottom of the screen will be enlarged and displayed at 600 pixels (1.5 times).

Pin Assignments and Signal Names for Analog RGB

Pin No.	Signal Name	Condition	Pin Location
1	Analog R	R signal input	
2	Analog G	G signal input	
3	Analog B	B signal input	
4	Reserved	NC (spare for input)	
5	Digital Grounding	Digital signal GND	
6	Return R	R signal GND	
7	Return G	G signal GND	
8	Return B	B signal GND	
9	Reserved	NC (spare for input)	
10	Digital Grounding	Digital signal GND	
11	Reserved	NC (spare for input)	
12	Reserved	NC (spare for input)	
13	H. SYNC	Horizontal synchronous signal input	
14	V. SYNC	Vertical synchronous signal input	
15	Reserved	NC (spare for input)	

Connector: Mini Dsub 15 pin type
 Connector set screw: Inch type (4-40)

Serial Interface

Serial Interface	Baud rate: 9600 bps Data length: 8 bits Parity: none Stop bit: 1
------------------	---

Pin Assignments and Signal Names for Serial Interface

Pin No.	Signal Name	Condition	Pin Location
1	CD	Carrier Detect (FP->Host)	
2	RD	Receive Data (FP->Host)	
3	SD	Send Data (FP<-Host)	
4	DIR	Data Terminal Ready (FP<-Host)	
5	GND	Ground	
6	DSR	Data Set Ready (FP->Host)	
7	RS	Request to Send (FP<-Host)	
8	CS	Clear to Send (FP->Host)	
9	NC	No connection	

Connector: Dsub 9 pin female
 Connector set screw: Inch type (4-40)

Concerning Signal Names

Signal names used for the serial interface on FP units are designed to match the pin order used on most PC serial interfaces, so that a straight cable can be used to connect the two. Therefore, connect each pin's signal to the same signal name on the PC side.

For example, pin #2 'RD' should be connected to the 'RD' input terminal on the PC's connector.

Refer to section "2-4 Cable Diagrams" for each signal's direction.

■ USB Interface

Pin Assignments and Signal Names for USB Interface

Pin NO.	Signal Name	Condition	Pin Location
1	USB1-5V	+5VIN	
2	USBD1(-)	USBdata(-)	
3	USBD1(+)	USBdata(+)	
4	GND	Ground	

Communication: Low speed Device
 Connector: B type connector

5 Installation

■ Confirm the Installation Gasket's Positioning

It is strongly recommended that you use the gasket. It absorbs vibration in addition to repelling water.

Place the FP on a level surface with the display panel facing downward. Check that the FP's installation gasket is seated securely into the gasket's groove, which runs around the perimeter of the panel's frame.



- **Before installing the FP into a cabinet or panel, check that the installation gasket is securely attached to the unit.**
- **A gasket which has been used for a long period of time may have scratches or dirt on it, and could have lost much of its dust and drip resistance. Be sure to change the gasket periodically (or when scratches or dirt become visible).**

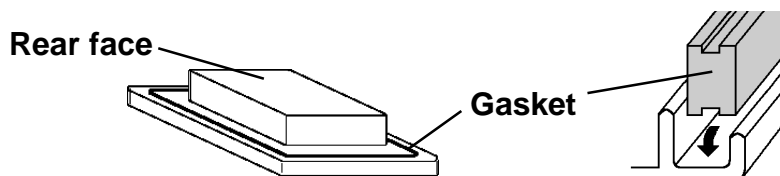

■ Create a Panel Cut and insert the FP into the panel from the front

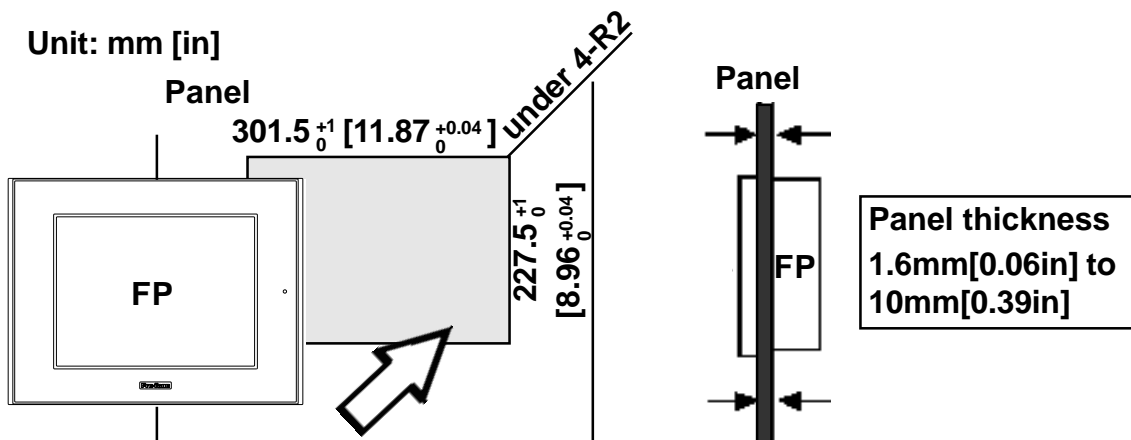

■ Attach the Installation Fasteners from Inside the Panel

The following figures show the four(4) fastener insertion slot locations. Insert each fastener's hook into the slot and tighten it with a screwdriver.

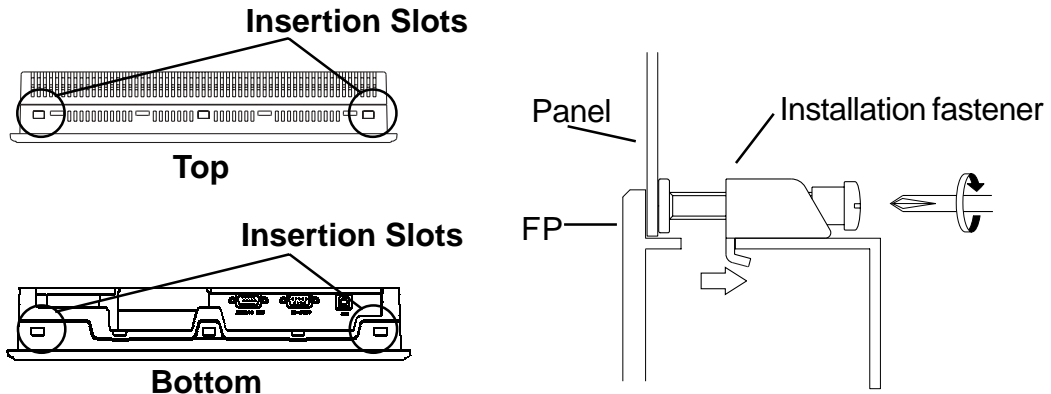

- **Tightening the screws with too much force can damage the FP's plastic case.**
- **The necessary torque is 0.5N•m.**



- Depending on the installation panel's thickness, etc., the number of installation fasteners used may need to be increased to provide the desired level of moisture resistance.
- If the number of the installation fasteners is increased, do not use the FP side face's middle installation fastener hole. Instead, use the top and bottom holes.

6 Wiring

WARNINGS

- To avoid an electric shock, when connecting the FP's power cord terminals to the power terminal block, confirm that the FP's power supply is completely turned OFF, via a breaker, or similar unit.
- The FP2500-T11/FP2600-T11 units are designed to use only AC100V input. Any other power level can damage both the FP and the power supply.
- Since there is no power switch on the FP unit, be sure to attach a breaker-type switch to its power cord.



- **When the FG terminal is connected, be sure the wire is grounded. Not grounding the FP unit will result in excess noise and vibration.**



- Wherever possible, use thick wires (max. 2 mm²) for power terminals, and twist the wire ends before attaching the ring terminals.
- Be sure to use the following size ring terminals.*1

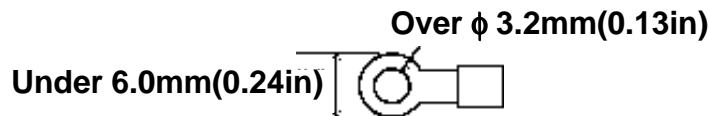

- To avoid a short caused by loose ring terminals, be sure to use ring terminals with an insulating sleeve.

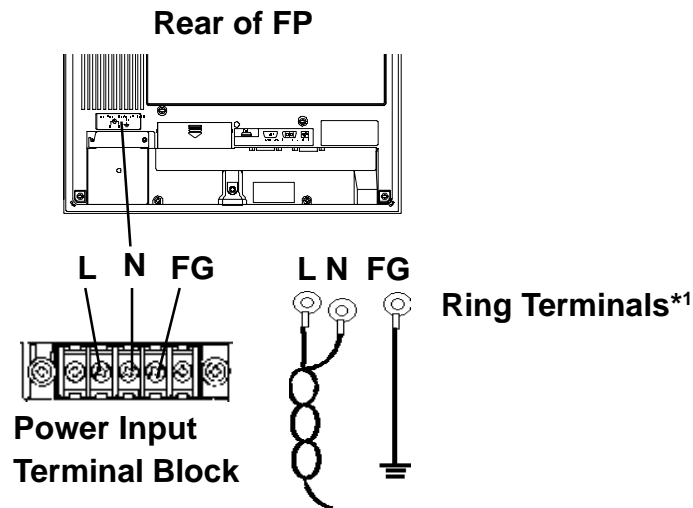

- *1 AC100V L=AC Input Terminal live line
 AC100V N=AC Input Terminal neutral line
 FG=Ground Terminal connected to the FP chassis
 Suggested Ring Terminal : V2-MS3 (made by JST)

■ Connecting the FP Power Cord

When connecting the power cord, be sure to follow the procedures given below.

1. Confirm that the FP's Power Cord is unplugged from the power supply.
2. Use a screwdriver to remove the Power Input Terminal Block's clear plastic cover.
3. Unscrew the screws from the middle three (3) terminals, align the Ring Terminals and re-attach the screws.
4. Confirm that the wires are connected correctly.
5. Replace the Power Input Terminal Block's clear plastic cover.



Note: The torque required to tighten these screws is 0.5 to 0.6 N•m.

7 Power Supply Cautions

Please pay special attention to the following instructions when connecting the power cord terminals to the FP unit.

- If the power supply voltage exceeds the FP's specified range, connect a voltage transformer.
- Between the line and the ground, be sure to use a low noise power supply. If there is still an excessive amount of noise, connect a noise reducing transformer.
- Input and Output signal lines must be separated from the power control cables for operational circuits.
- To increase the noise resistance, be sure to twist the ends of the power cord wires before connecting it to the FP unit.
- The FP's power supply cord should not be bundled with or kept close to main circuit lines (high voltage, high current), or input/output signal lines.
- Connect a surge absorber to handle power surges.
- To reduce noise, make the power cord as short as possible.

8 Grounding Caution

When attaching a wire to the FP's rear face FG terminal, (on the Power Input Terminal Block), be sure to create an exclusive ground.*1

9 Input/Output Signal Line Cautions

- All FP Input and Output signal lines must be separated from all operating circuit (power) cables.
- If this is not possible, use a shielded cable and ground the shield.

10 Replacing the Backlight

The FP unit's backlight is user replacable.

For an explanation of how to replace the FP's backlight, please refer to the Installation Guide.

Corresponding Replacement Backlights

FP Unit	Backlight Model
FP2500-T11	GP577RT-BL00-MS
FP2600-T11	PS600-BU00



Use of a different model backlight may cause a FP malfunction or breakdown.

***1** *Use a grounding resistance of 100Ω, a wire of 2mm² or thicker, or your country's applicable standard.*

Note

Please be aware that Digital Electronics Corporation shall not be held liable by the user for any damages, losses, or third party claims arising from the uses of this product.

Digital Electronics Corporation

8-2-52 Nanko Higashi, Suminoe-ku, Osaka 559-0031, Japan

URL: <http://www.pro-face.com/>