

**Digital**  
*Human Machine Interface*

Industrial automation

**Elincom Group**

 European Union: [www.elinco.eu](http://www.elinco.eu)

 Russia: [www.elinc.ru](http://www.elinc.ru)

**Pro-face**

# FP2500-T41 User Manual

**Digital**

Digital Electronics Corporation

## Preface

Thank you for purchasing Digital's TFT type color display panel, the 'FP2500-T41' (hereafter referred to as the *FP unit*).

The FP unit is a TFT type color liquid crystal display monitor for IBM-PC compatible personal computers (VGA mode).

Please read this manual completely to insure the correct use and complete understanding of the FP unit's functions. The FP's analog interface is designed for use with standard VGA mode. Please be aware that this unit may not be able to be connected with nonstandard VGA modes. For more details, please refer to this manual's "PC Connectivity Notes" section.

**The term FP2500-T41 refers to the following unit:**

FP2500-T41-24V

(DC 24V type)

<Note>

- 1) It is forbidden to copy the contents of this manual, in whole or in part, except for the user's personal use, without the express permission of the Digital Electronics Corporation of Japan.
- 2) The information provided in this manual is subject to change without notice.
- 3) This manual has been written with care and attention to detail; however, should you find any errors or omissions, please contact Digital Electronics and inform them of your findings.
- 4) Please be aware that Digital Electronics is not responsible for any damages resulting from the use of our products, regardless of article 3 above.
- 5) Specifications set out in this manual are for overseas products only, and, as a result, some differences may exist between the specifications given here and the Japanese ones.

All Company/Manufacturer names used in this manual are the registered trademarks of their respective companies.

© 2001, Digital Electronics Corporation

# For the Safe And Correct Use of this Unit:

This manual describes safety instructions for correct use of the FP unit. Please keep this manual close at hand, and refer to it when necessary.

The following symbols are used throughout this manual to ensure the safe use of the FP unit. Please make sure to follow all instructions given since they explain important safety points.

 <b>Warning</b>	This mark warns of a situation that could either seriously injure a person or lead to death if the instruction is ignored and/or the unit is used incorrectly.
--	--

 <b>Caution</b>	This mark warns of a situation that could either injure a person or damage property if the instruction is ignored and/or the unit is used incorrectly.
--	--

## Other Symbols Used In This Manual

---

The list below describes the symbols used in this manual.



Explains a situation that requires a moderate amount of caution.



Indicates a word or phrase that has an additional explanation.

\*1

A reference point. Describes the word or phrase marked by the asterisk (\*) and the corresponding number.



Reference pages on related topics.

1),2)

Operational steps. Please follow these numbered steps in order to perform the desired operation.



## Warning

# Safety Instructions

For the safe use of this unit, be sure to follow these guidelines:

- Because of the ever present danger of electrical shock, be sure to unplug the power cable from the FP unit before plugging the cable's other end into the wall.
- Do not use power in excess of the unit's specified voltage range since it may cause a fire or electric shock.
- Because the FP unit contains high voltage parts, an electric shock can occur when disassembling the unit. Therefore, please be sure to always unplug the unit before disassembling it.
- Do not modify the FP unit in any way, since it may cause a fire or electric shock.
- When changing the backlight, be sure to turn off the unit's power first, in order to prevent an electric shock.
- Do not use touch panel keys to perform life-threatening or vitally important safety functions. Use separate mechanical switches for such keys.
- If substantial amounts of metallic dust, water or liquids enter the FP unit, turn off the power supply immediately, unplug the power cord, and contact your local FP distributor.
- When installing the FP unit, be sure to follow the instructions given in "Chapter 3. Installation and Wiring," to insure it is done correctly.
- Do not use the FP in an environment with flammable gas since it may cause an explosion.



## Caution

# Safety Instructions

For the correct use of this unit, please follow these guidelines:

- Do not press the screen's touch surface too strongly with either your finger or a hard object, since the touch surface may be damaged.
- When the surface of the display screen becomes dirty or smudged, clean the display with a cloth soaked in a neutral detergent. Do not use paint thinner or organic solvent.
- Do not press on the touch panel's face with sharp objects, such as a mechanical pencil or screwdriver, since it might damage the LCD panel.
- Avoid using or storing the FP in direct sunlight, excessively dusty or dirty environments, or where chemicals or their vapors are present in the air.
- Avoid restricting the FP's natural ventilation, or storing and using the FP in an environment that will increase the FP's internal temperature.
- Please avoid using the FP in areas where sudden, large changes in temperature may occur. These changes can cause condensation to form inside the unit, possibly causing an accident.

### **Notes on the FP's Liquid Crystal Display (LCD)**

- The FP's LCD contains a strong irritant. If the panel is ever cracked and the LCD's liquid contacts your skin, be sure to wash it with running water for at least 15 minutes. If any of this liquid should enter your eye, be sure to flush the eye with running water for more than 15 minutes, and see a doctor immediately.
- The current brightness of the LCD screen will depend on the screen's current display and the LCD's contrast adjustment. Any brightness variations that result are normal for LCD displays.
- There are minute grid-points on the LCD surface. These points are not defects.
- Sometimes crosstalk (shadows appearing on extended display lines) will appear on the display. This phenomenon is a common attribute of LCD's and is not a defect.
- The displayed color will look different when viewed from an angle outside the specified view angle. This is also normal.
- Displaying a single screen image for long periods of time can cause an afterimage to remain. To correct this, turn the unit OFF for 5 or 10 minutes, then ON again. This phenomenon is a common attribute of the LCD's, and not a defect. To prevent this effect, you can:
  - use the Display OFF feature, if the same image is to be displayed for a long period of time.
  - change the screen display periodically to prevent the displaying of a single image for a long period of time.

# Table of Contents

Preface .....	i
For the Safe and Correct Use of this Unit .....	ii
Warning: Safety Instructions .....	iii
Caution: Safety Instructions .....	iv
Table of Contents .....	v
When Connecting to a PC .....	vii
FP2500-T41 Features .....	viii
Package Contents .....	ix
UL/c-UL (CSA) Application Notes .....	x
CE Making Notes .....	x

## Chapter 1—Introduction

1-1 Connecting the FP to a PC .....	1-1
1-2 Optional Equipment .....	1-2

## Chapter 2—Specifications

2-1 General Specifications (For DC24V) .....	2-1
1 Electrical Specifications .....	2-1
2 Environmental Specifications .....	2-1
3 Structural Specifications .....	2-2
2-2 Functional Specifications (For DC24V) .....	2-3
2-3 Interface Specifications (For DC24V) .....	2-4
1 Analog RGB Interface .....	2-4
2 Serial Interface .....	2-6
3 USB Interface .....	2-7
2-4 Cable Diagrams .....	2-8
1 Pin Connections for the RGB Interface Cable .....	2-8
2 Pin Connections for the SIO Interface Cable .....	2-9
3 Pin Connections for the USB Interface Cable .....	2-9
2-5 Names and Functions of FP Parts .....	2-10
2-6 Flat Panel (FP) Dimensions .....	2-11
1 External Dimensions (DC24V) .....	2-11
2 Installation Brackets .....	2-12
3 FP Installation Dimensions .....	2-12

## **Chapter 3—Installation and Wiring**

3-1	Installation .....	3-1
3-2	Wiring .....	3-5
	1 Power Cable Connection .....	3-5
	2 Precautions: Connecting the Power Supply .....	3-6
	3 Precautions: Grounding .....	3-7
	4 Precautions: Input/Output Signal Lines .....	3-7
3-3	Operation Mode Setup and Display Positioning .....	3-8
	1 Operation Mode Setup and Adjustment .....	3-8
	2 Front LED Option Mode Display .....	3-9
	3 Display Position Compensation by OSD .....	3-10

## **Chapter 4—Touch Panel Commands**

4-1	Command List .....	4-1
4-2	Boot-up Initialization .....	4-2
4-3	Touch Interface Data .....	4-3
4-4	Touch Panel Commands .....	4-5

## **Chapter 5—Touch Panel Communication Programs**

5-1	Bundled Software .....	5-1
5-2	Operation Environment .....	5-2
5-3	Touch panel Input Drivers .....	5-3
	1 FPATPH.EXE (Touch Panel Handler) .....	5-3
	2 FPCALIB.EXE (Touch Panel Data Calibration) .....	5-7

## **Chapter 6—Troubleshooting**

6-1	Troubleshooting .....	6-1
	1 Possible Device Problems .....	6-1
	2 No Display .....	6-2
	3 Touch Panel Does Not Work .....	6-4

## **Chapter 7—Maintenance**

7-1	Regular Cleaning .....	7-1
	1 Cleaning the Display .....	7-1
	2 Installation Gasket Check/Replacement .....	7-1
7-2	Periodic Check Points .....	7-2
7-3	Replacing the Backlight .....	7-3

<b>INDEX</b> .....	<b>i - iv</b>
--------------------	---------------

## When Connecting to a PC

The FP unit's analog interface is designed for standard VGA mode. The number of dots (pixels) displayed are as follows:

Size	H Sync.	V Sync.	Dot Clock Range
640 X 480	31.469±1 KHz	60±1 Hz	25.175MHz±1%
640 X 400	24.827±1 KHz	56±1 Hz	21.053MHz±1%
640 X 400	31.469±1 KHz	70±1 Hz	25.175MHz±1%
640 X 350	31.469±1 KHz	70±1 Hz	25.175MHz±1%
720 X 400	31.469±1 KHz	70±1 Hz	28.322MHz±1%
720 X 350	31.469±1 KHz	70±1 Hz	28.322MHz±1%



- Changeover from horizontal 720 pixels to 640 pixels is done via DIP switch.
- When the horizontal 720 pixel signal is input;
  - VGA Graphic & Text mode displays 640 pixels only and 80 pixels are not displayed.
  - VGA Graphic mode displays all pixels but images may be cut off if they do not match the sampling.
- With vertical 350 pixels, 400 pixels, including 50 pixels at the top and at the bottom of the screen will be enlarged and displayed at 480 pixels (1.2 times).
- When the unit is used in VGA text mode, the far right side's 80 dots are not displayed.
- The display mode is designated using dip switch SW1-4.

Some types of VGA equipment may not be within the ranges specified above, and, therefore, cannot be connected to the FP.

Also, if the user changes his PC's VGA board, there is the possibility that the new board may not be able to be connected to the FP.



# FP2500-T41 Features

The features of the FP2500-T41 are as follows.

- **High Quality TFT Color LCD Display**

This unit is equipped with a 10.4 inch TFT type color LCD. Its superior brightness and wide viewing angle, not found in ordinary laptop type TFT LCD's, widens your scope of applications.

The screen's maximum resolution is 640 x 480 pixels, and can display 260,000 colors.

**Easy Installation In User's Cabinets and Panels**

- The FP2500-T41's slim, lightweight, and compact design make installation a snap. It was designed specifically for use as your IA (Industrial Automation) or OA (Office Automation) system monitor. The flat, front panel provides protection equivalent to the rigorous IP65F standard, and, even without its optional protective cover, the front panel is highly resistant to both water and dust.

**Panel can be used as a VGA Display**

- Since the FP2500-T41 is equipped with an analog RGB interface, it can be connected to any PC with standard VGA mode. (The PC's clock frequency, however, must be within the standard range)

**Easy to use Built In Touch Panel**

- The FP2500-T41's built in touch panel is standard equipment, allowing touch panel data to be output to a host PC via input/output commands and an RS-232C cable and USB cable. This is perfect for systems requiring both touch panel operation and data monitoring.

# Package Contents

The FP's packing box contains the items listed below. Please check to be sure each is included and is not damaged.

■ **FP unit (FP2500-T41-24V)**

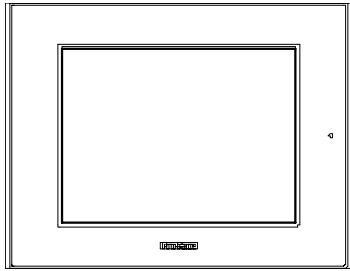

■ **FP2500/2600**

**User Manual**(Contained in plastic case)

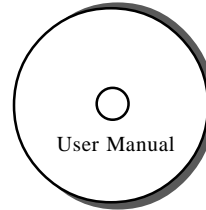

■ **Installation Gasket (1)**



■ **Installation Brackets (4)**

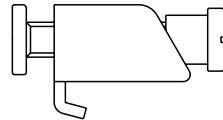

■ **3.5 inch floppy disk**  
(Contains Touch Panel programs)

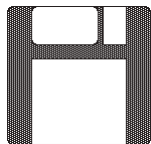

■ **FP2500-T41/FP2600-T41**  
**Installation Guide (1)**

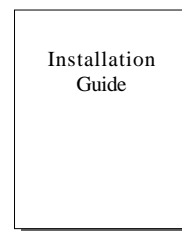

These items have all been carefully packed with special attention to product quality. However, should you find anything damaged or missing, please contact your local distributor immediately for prompt service.

## UL/c-UL (CSA) Application Notes

The FP2500-T41-24V is a UL/c-UL (CSA) listed product. (UL file No.E182139)

**This unit conforms as a product to the following standards:**

■ **UL508** Industrial Control Equipment

■ **UL1604** Electrical Equipment for use in Class 1 & 2 - Division 2, or Class 3 Hazardous Locations.

■ **CAN/CSA-C22.2, No. 1010-1**

MESUREMENT AND CONTROL EQUIPMENT

(Safety requirements for electrical equipment for measurement and laboratory use)

**FP2500-T41-24V(UL Registration Model: 30B0003-01)**

<Cautions>

- The FP must be used as a built-in component of an end-use product.
- This unit should be installed in the front face of a metal panel.
- If this unit is installed so as to cool itself naturally, be sure to install it in a vertical panel. Also, be sure that the FP unit is mounted at least 100 mm away from any adjacent structures or equipment. If these requirements are not met, the heat generated by the FP unit's internal components may cause the unit to fail to meet UL/c-UL standard requirements.

**UL1604 Conditions of Acceptability and Handling Cautions:**

1. Power, input and output (I/O) wiring must be in accordance with Class I, Division 2 wiring methods-Article 501-4(b) of the National Electrical Code, NFPA 70 within the United States, and in accordance with Section 18-152 of the Canadian Electrical Code for units installed within Canada.
2. Suitable for use in Class I, Division 2, Groups A, B, C and D, Hazardous Locations.
3. WARNING: Explosion hazard - substitution of components may impair suitability for Class I, Division 2.
4. WARNING: Explosion hazard - when in hazardous locations, turn power OFF before replacing or wiring modules.
5. WARNING: Explosion hazard - do not disconnect equipment unless power has been switched OFF, or the area is known to be non-hazardous.

## CE Marking Notes

The FP2500-T41 -24V is a CE marked product that conforms to EMC directives EN55011 class A and EN61000-6-2.

*\*For detailed CE marking information, please contact your local FP distributor.*

# Chapter 1

## Introduction

1. Connecting the FP to a PC
2. Optional Equipment

The following diagram illustrates the connection between the FP unit and a PC.

### 1-1 Connecting the FP to a PC

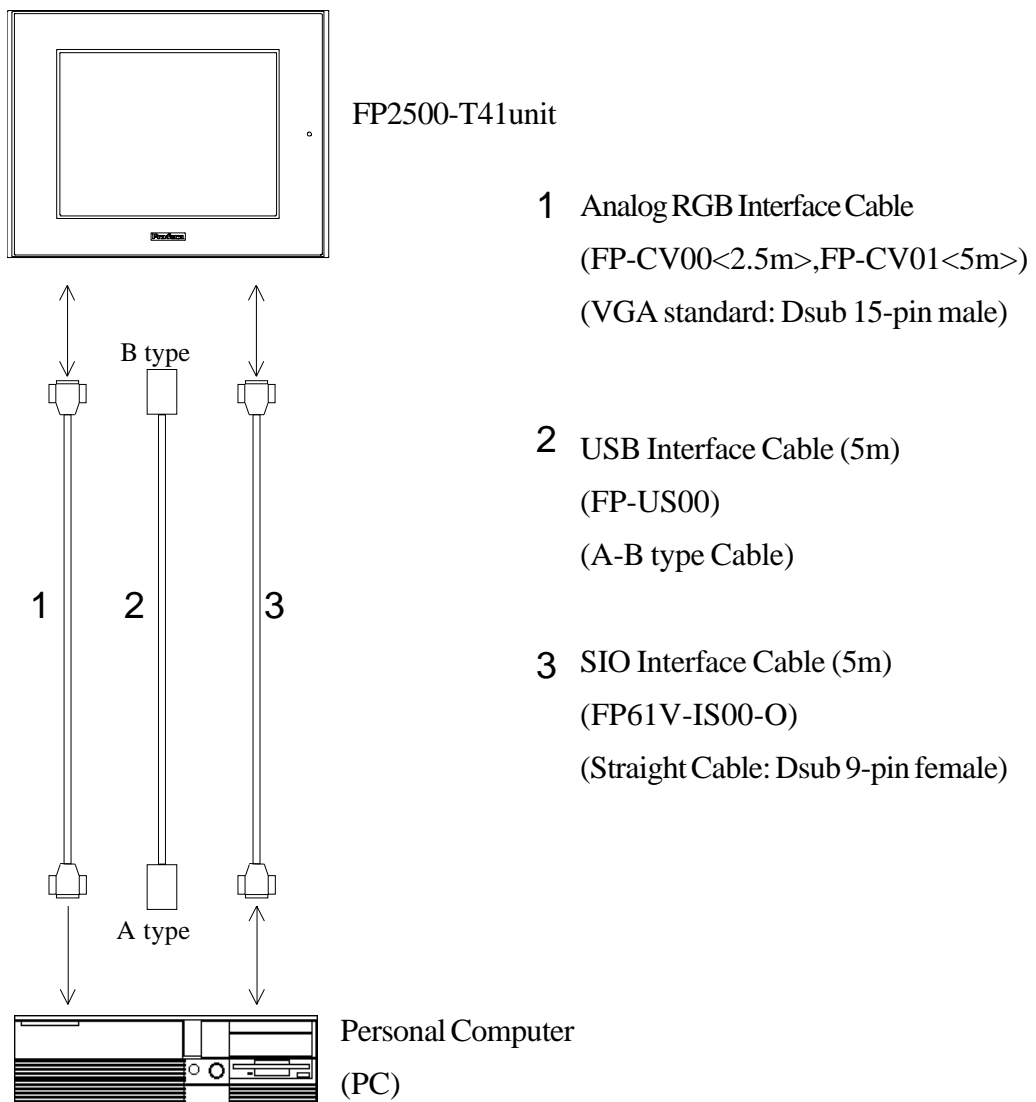

## 1-2 Optional Equipment

All optional items listed below are products of Digital Electronics Corporation.

Item		Model	Description
Interface	SIO Cable	FP61V-IS00-O	Serial interface cable (5m) used for touch panel data transmission between the host and the FP or command transmission to the FP. This is a straight Dsub9 pin female cable.
	RGB Cable	FP-CV00 FP-CV01	Analog RGB interface cable when image signal is output to the FP from the host. VGA specifications (Dsub15 pin male) FP-CV00 (2.5m), FP-CV01 (5m)
	USB Cable	FP-US00	USB interface cable (5m) used for touch panel data transmission between the host and the FP or command transmission to the FP. A-B type cable.
Maintenance Parts	Backlight Bulbs	GP577RT-BL00-MS	Replacement Backlight bulbs .
	Installation Brackets	GP070-AT01	Metal installation brackets for FP2500-T41
	Rubber Gasket	GP-WP10-MS	Replacement rubber gasket, used when installing the FP. Same as the FP's original gasket.
Optional Parts	Cover Sheet (Hard type)	PSL-DF00	Provides disposable screen protection from dust and other elements. The touch panel can be used with the Cover Sheet attached (5 sheets / set)
	Mouse Emulator V2	PL-TD000	Mouse Emulator software for FP

\* Operation environment is Windows®95, WindowsNT®4.0, Windows®98, Windows®2000.



When you use PL-TD000, hardware settings can not be automatically detected.

As a result, select the FP unit's currently connected COM Port, and enter the settings given in the FP manual for the Allocated I/O address and Interrupt.

# Chapter 2

## Specifications

1. General Specifications
2. Functional Specifications
3. Interface Specifications
4. Cable Diagrams
5. Names and Functions of FP Parts
6. Flat Panel (FP) Dimensions

### 2-1 General Specifications (For DC24V)

#### 2-1-1 Electrical Specifications

Rated Voltage	DC24V
Rated Voltage Range	DC 19.2V to DC 28.8V
Power Consumption	50W or less
In-Rush Current	30A or less
Voltage Endurance	AC1000V 20mA for 1minute (between charging and FG terminals)
Insulation Resistance	10M $\Omega$ or higher at DC500V (between charging and FG terminals)

#### 2-1-2 Environment Specifications

	DC24V (FP2500-T41)
Operating Temperature	0 °C to 50 °C
Storage Temperature	-10 °C to 60 °C
Humidity	30 to 85%RH (non-condensing)
Vibration Endurance	19.8m/s <sup>2</sup> - 10 to 25 Hz (X,Y,Z directions - 30 minutes each)
Noise Immunity	Noise voltage: 1000 Vp-p
	Pulse length: 1 $\mu$ s
	Rise time (rise/fall): 1 ns
Pollution Level	Not immune to corrosive gas
Grounding	Less than 100 $\Omega$ , or your country's applicable standard
Protection*1	Equivalent to IP65f (JEM1030)

\*1 (See the next page's note)

\*1 (Continued from previous page)

*The front face of the FP unit, installed in a solid panel, has been tested using conditions equivalent to the standard shown in the specification . Even though the FP unit's level of resistance is equivalent to the standard, oils that should have no effect on the FP can possibly harm the unit. This can occur in areas where either vaporized oils are present, or where low viscosity cutting oils are allowed to adhere to the unit for long periods of time. If the FP's front face protection sheet becomes peeled off, these conditions can lead to the ingress of oil into the FP and separate protection measures are suggested. Also, if non-approved oils are present, it may cause deformation or corrosion of the front panel's plastic cover. Therefore, prior to installing the FP be sure to confirm the type of conditions that will be present in the FP's operating environment.*

*If the installation gasket is used for a long period of time, or if the unit and its gasket are removed from the panel, the original level of the protection cannot be guaranteed. To maintain the original protection level, you need to replace the installation gasket regularly.*

### 2-1-3 Structural Specifications

---

	<b>DC24V (FP2500-T41)</b>
External Dimensions	317W x 243H x 58D mm
Weight	3.5 kg or less
Cooling System	Natural air circulation

## Specifications

<b>2-2</b>	<b>Functional Specifications (For DC24 V )</b>
------------	--

<b>Display Media</b>	TFT Active matrix color LCD
<b>Display Size</b>	26cm (type 10.4) Opposite angle
<b>Display Area (mm)</b>	221.2W × 158.4H
<b>Resolution</b>	640(H)×480(V)pixels(1pixel=R+G+B pixel)
<b>Display Colors</b>	262,144 colors (R/G/B Six bits each)
<b>Brightness</b>	240cd/m <sup>2</sup> (typ) <sup>*1</sup>
<b>Dot Pitch (mm)</b>	0.33H×0.33W
<b>Touch Panel</b>	Resolution: 1024×1024
	Method : Resistive Film (Analog)
<b>Display Mode</b>	<ul style="list-style-type: none"> <li>• VGA graphic &amp; Text mode 640X480, 640X400, 640X350 mode display available. 720X400, 720X350 mode are also available, however, the 720X400, 720X350 screens will display only at 640 pixels and the right side's horizontal 80 pixels do not display.</li> <li>• VGA Graphic mode (DIPSW 4 is ON.) 640X480, 640X400, 640X350 mode display available. In this case, the resolution 720X400, 720X350 displays as horizontal 640 pixels, but the images may be cut if they do not match sampling. However, all modes 400 lines and 350 lines are center displayed. With 350 pixels, 400 pixels, including 50 pixels at the top and bottom will be enlarged and displayed as 480 pixels (1.2 times).</li> </ul>
<b>Interfaces</b>	Analog RGB Interface SIO Interface(touch Interface) USB Interface(touch Interface)
<b>Backlight</b>	<ul style="list-style-type: none"> <li>• Backlight can be changed.</li> <li>• Lifetime : 50,000 hours when continuously lit (*2) at 25 °C.</li> </ul>

\*1 The brightness at central part of the screen when displaying all white.

\*2 2.5 times decreased brightness may be the life span, but this value is only for reference and not a guaranteed value.



## 2-3 Interface Specifications (For DC 24V)

### 2-3-1 Analog RGB Interface

Input signal type	Analog RGB
Input signal characteristic	Image signal: analog RGB Synchronous signal: TTL level, negative true or positive true Scanning type: non-interlase
Setting by OSD (On Screen Display)	Contrast Adjustment Sub Contrast Adjustment Brightness Adjustment Horizontal Display Position Adjustment Vertical Display Position Adjustment Horizontal Adjustment Phase Adjustment Dimmer Adjustment Default Setting (All Clear Function)

Size	H Sync.	V Sync.	Dot Clock Range
640 X 480	31.469±1 KHz	60±1 Hz	25.175MHz±1%
640 X 400	24.827±1 KHz	56±1 Hz	21.053MHz±1%
640 X 400	31.469±1 KHz	70±1 Hz	25.175MHz±1%
640 X 350	31.469±1 KHz	70±1 Hz	25.175MHz±1%
720 X 400	31.469±1 KHz	70±1 Hz	28.322MHz±1%
720 X 350	31.469±1 KHz	70±1 Hz	28.322MHz±1%



- Changeover from horizontal 720 pixels to 640 pixels is done via DIP switch.
- When the horizontal 720 pixel signal is input;
  - VGA Graphic & Text mode displays 640 pixels only and 80 pixels are not displayed.
  - VGA Graphic mode displays all pixels but images may be cut off if they do not match the sampling .
- With vertical 350 pixels, 400 pixels including 50 pixels at the top and at the bottom of the screen will be enlarged and displayed at 480 pixels (1.2 times).
- In VGA Graphic & text mode, the far right side's 80 pixels do not display.
- Selection of display mode is done via switch SW1-4.

# Specifications

## Pin Assignments and Signal Names for Analog RGB

Pin No.	Signal Name	Condition	Pin Location
1	Analog R	R signal input	<p>The diagram shows a vertical Mini Dsub 15 pin connector. It has two hexagonal mounting holes at the top and bottom. The pins are arranged in a 3x5 grid. Pin 1 is at the bottom right, pin 5 is at the top right, pin 11 is at the bottom left, and pin 15 is at the top left.</p>
2	Analog G	G signal input	
3	Analog B	B signal input	
4	Reserved	NC (spare for input)	
5	Digital grounding	Digital signal GND	
6	Return R	R signal GND	
7	Return G	G signal GND	
8	Return B	B signal GND	
9	Reserved	NC (spare for input)	
10	Digital grounding	Digital signal GND	
11	Reserved	NC (spare for input)	
12	Reserved	NC (spare for input)	
13	H. SYNC	Horizontal synchronous signal input	
14	V. SYNC	Vertical synchronous signal input	
15	Reserved	NC (spare for input)	

Connector: Mini Dsub 15 pin type  
 Connector set screw: Inch type (4-40)

## 2-3-2 Serial Interface

Serial Interface	Baud rate: 9600 bps Data length: 8 bits Parity: none Stop bit: 1
------------------	---

### Pin Assignments and Signal Names for Serial Interface

Pin No.	Signal Name	Condition	Pin Location
1	CD	Carrier Detect (FP->Host)	
2	RD	Receive Data (FP->Host)	
3	SD	Send Data (FP<-Host)	
4	DTR	Data Terminal Ready (FP<-Host)	
5	GND	Ground	
6	DSR	Data Set Ready (FP->Host)	
7	RS	Request to Send (FP<-Host)	
8	CS	Clear to Send (FP->Host)	
9	NC	No connection	

Connector: Dsub 9 pin female  
 Connector set screw: Inch type (4-40)

#### Concerning Signal Names

Signal names used for the serial interface on FP units are designed to match the pin order used on most PC serial interfaces, so that a straight cable can be used to connect the two. Therefore, connect each pin's signal to the same signal name on the PC side.

For example, pin #2 'RD' should be connected to the 'RD' input terminal on the PC's connector.

Refer to section "2-4 Cable Diagrams" for each signal's direction.

# Specifications

## 2-3-3 USB Interface

---

### Pin Assignments and Signal Names for USB Interface

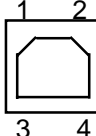
Pin NO.	Signal Name	Condition	Pin Location
1	USB1-5V	+5VIN	
2	USBD1(-)	USBdata(-)	
3	USBD1(+)	USBdata(+)	
4	GND	Ground	

Communication      Low speed Device  
Connector:          B type connector

**2-4 Cable Diagrams**

**2-4-1 RGB Interface Cable Pin Connections**

FP side			RGB cable			PC side			
1	Analog R	Input	1	RED IN	RED VIDEO	1	Output	RED VIDEO	1
2	Analog G	Input	2	GRN IN	GRN VIDEO	2	Output	GRN VIDEO	2
3	Analog B	Input	3	BLU IN	BLU VIDEO	3	Output	BLU VIDEO	3
4	Reserved	--	4	NC	NC	4	--	NC	4
5	Digital ground	--	5	GND	GROUND	5	--	GROUND	5
6	Return R	--	6	RED GND	GROUND RED	6	--	GROUND RED	6
7	Return G	--	7	GRN GND	GROUND GRN	7	--	GROUND GRN	7
8	Return B	--	8	BLU GND	GROUND BLU	8	--	GROUND BLU	8
9	Reserved	--	9	NC	NC	9	--	NC	9
10	Digital ground	--	10	GND	GROUND	10	--	GROUND	10
11	Reserved	--	11	NC	MONITOR SENSE(COLOR)	11	--	MONITOR SENSE(COLOR)	11
12	Reserved	--	12	NC	MONITOR SENSE(MONO)	12	--	MONITOR SENSE(MONO)	12
13	H.SYNC	Input	13	HSYN	HSYN	13	Output	HSYN	13
14	V.SYNC	Input	14	VSYN	VSYN	14	Output	VSYN	14
15	Reserved	--	15	NC	NC	15	--	NC	15
FG	FG	--	FG	FG	FG	FG			



Signal names for the FP's RGB interface are designed to match the same pin order as the RGB interface on personal computers.

# Specifications

## 2-4-2 Pin Connections for the SIO Interface Cable

---

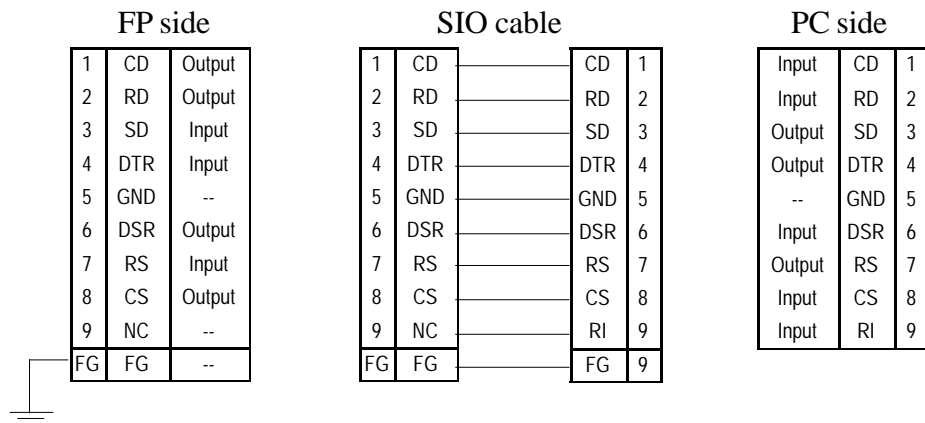

Signal names for the FP's SIO interface are designed to match the same pin order as the SIO interface on a standard PC.

## 2-4-3 Pin Connections for the USB Interface Cable

---

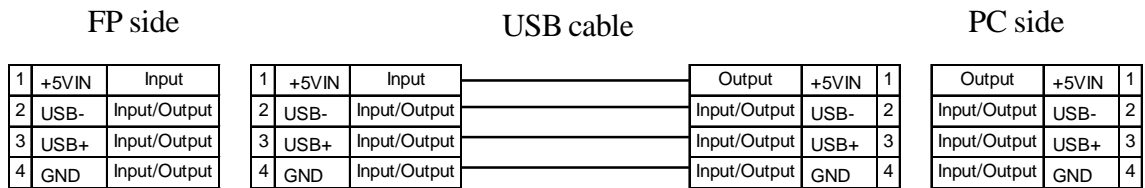

## 2-5 Names and Functions of FP Parts

Front View

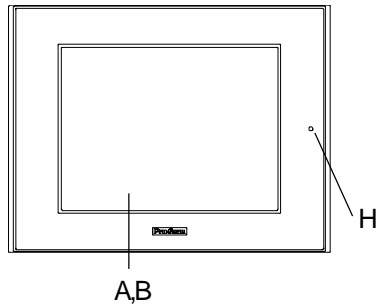

- A: **TFT Color LCD**  
The display monitor for your host.
- B: **Touch Panel**  
Allows you to perform touch operation.
- C: **Power Input Terminal Block**  
Provides the input and ground terminals for a power cable.
- D: **Setting Switch (Dip switch)**

E: **VGA Interface (analog RGB) Connector**

F: **Serial Interface Connector**  
Used for both sending touch panel data to the host, and receiving commands from the host.

G: **USB Interface Connector**  
Used for both sending touch panel data to the host, and receiving commands from the host.

H: **Front LED**  
An LED to detect power supply, backlight burning out and input of image signal.

Rear View

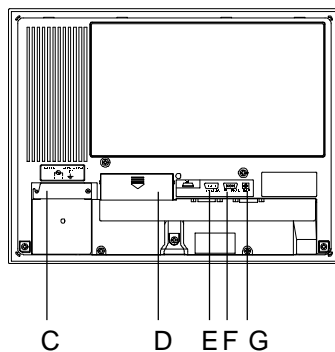

**REFERENCE** → 3-3-2 Front LED Operation Mode Display

# Specifications

## 2-6 Flat Panel (FP) Dimensions

### 2-6-1 External Dimensions ( DC24V )

Unit: mm [in.]

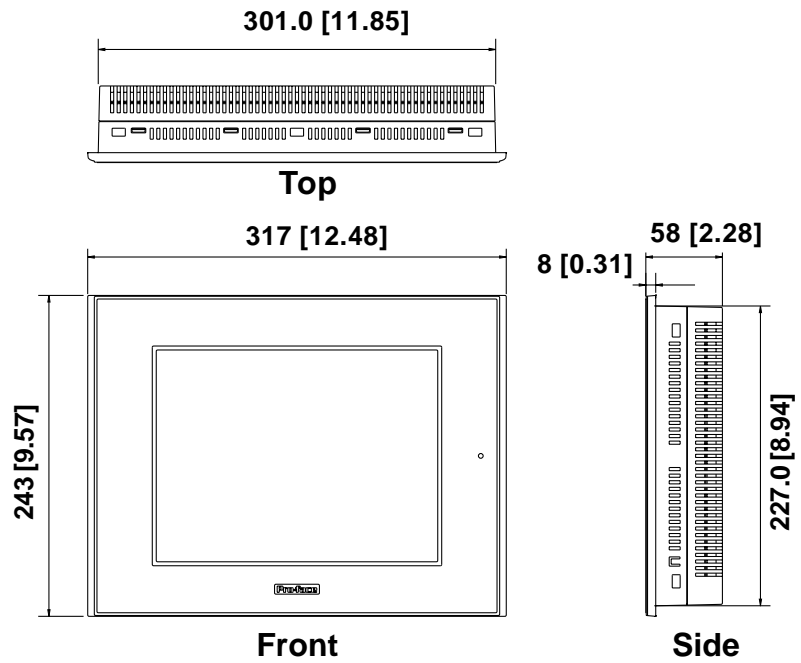



2-6-2 Installation Brackets

Unit: mm [in.]

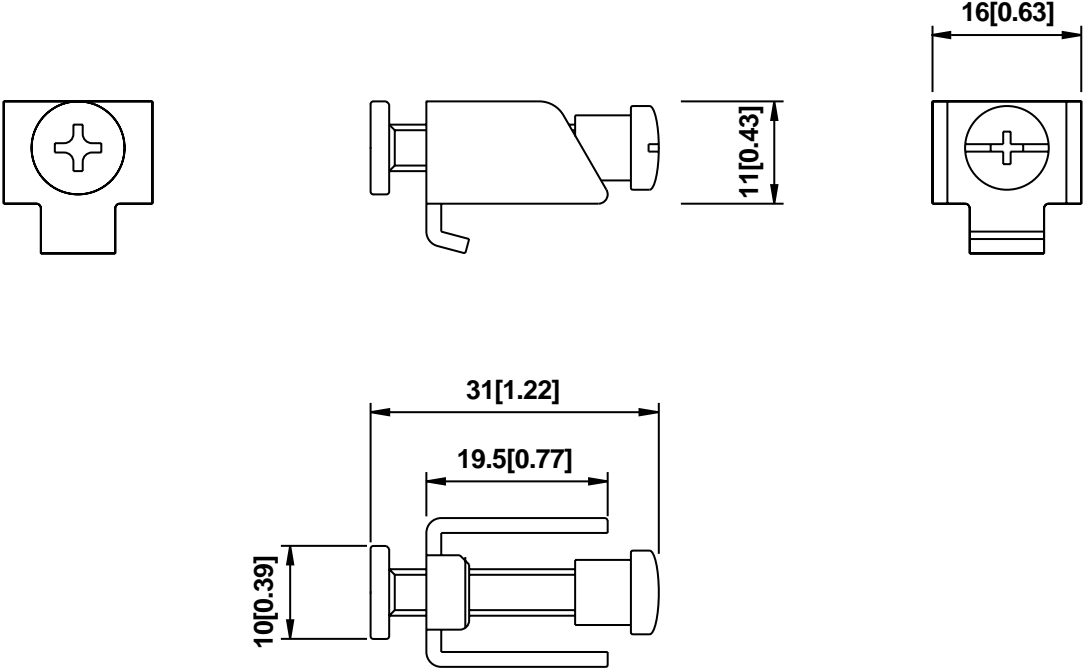

2-6-3 FP Installation Dimensions

Unit: mm [in.]

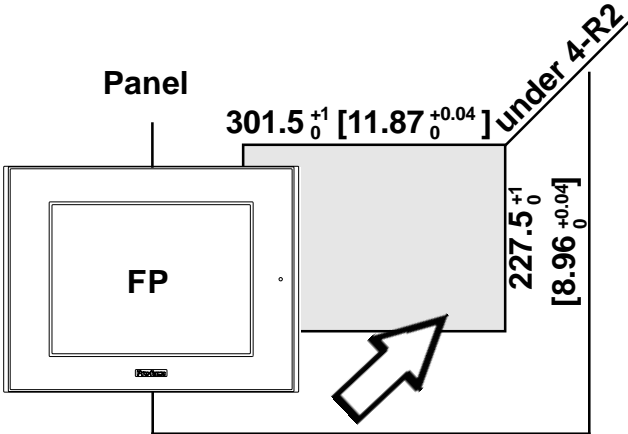

## Chapter 3

# Installation and Wiring

1. Installation
2. Wiring
3. Operation Mode Setup and Display Positioning

### 3-1 Installation

Install the FP unit using the following steps.

#### Confirm the Installation Gasket's Positioning

It is strongly recommended that you use the gasket. It absorbs vibration in addition to repelling water.

Place the FP on a level surface with the display panel facing downward.

Check that the FP's installation gasket is seated securely into the gasket's groove, which runs around the perimeter of the panel's frame.



A gasket which has been used for a long period of time may have scratches or dirt on it, and could have lost much of its dust and drip resistance. Be sure to change the gasket periodically (or when scratches or dirt become visible).

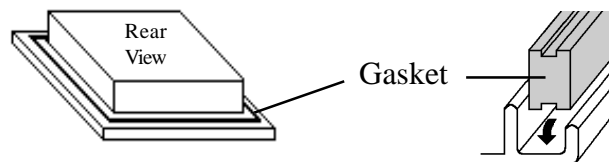

#### Create a Panel Cut

Following the FP Installation dimensions, create (cut) the FP opening required for installation. The FP's rubber gasket, installation brackets and screws are all required when installing the FP. **REFERENCE →** Chapter 2-6-3 "FP Installation Dimensions".

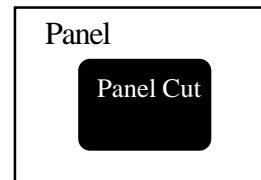

- It is important that the panel surface is flat, clean, and has no jagged edges.
- The Panel thickness should be between 1.6mm and 10.0mm.

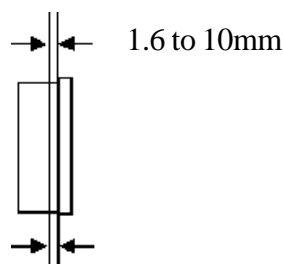

## Installation and Wiring



- For easier maintenance and operation, and improved ventilation, be sure the FP unit is mounted at least 100 mm away from any adjacent structures or objects.

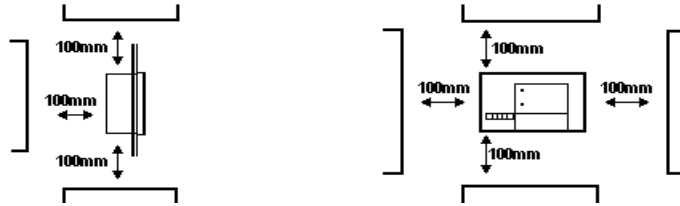

- The FP uses natural ventilation through its outer shell for cooling. When installing the unit horizontally or sideways (portrait style), use a fan or air conditioning unit to prevent overheating.

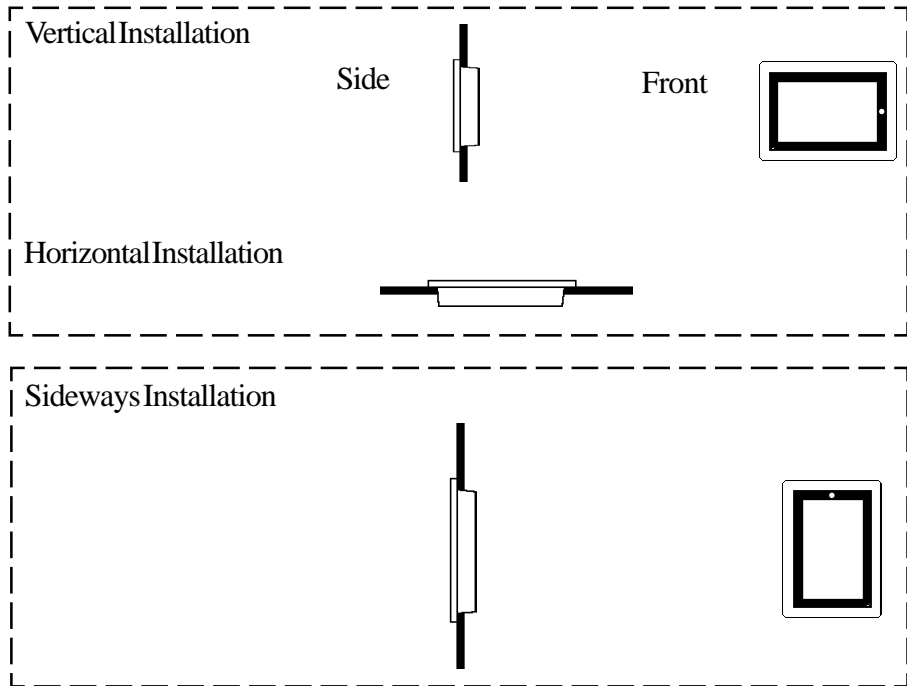

- When installing the FP sideways, place it so that the Power Terminals point upwards.
- Check that heat from surrounding equipment will not cause the FP to overheat.
- Do not use the FP2500-T41 in an environment that exceeds 50°C.
- Ensure this unit is located as far away as possible from electromagnetic circuits, non-fuse type breakers, and other equipment that can cause arcing.
- When installing the FP unit in a panel with an angled face, the face should not incline either backwards or forwards more than 30°.

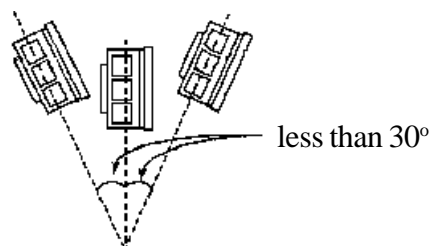

# Installation and Wiring

## ■ Installing the FP Panel

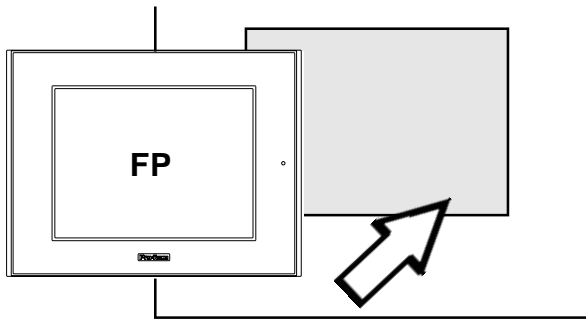

1) Insert the FP into the panel cut out, as shown here.

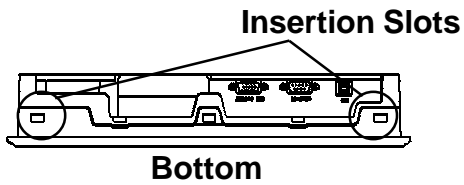
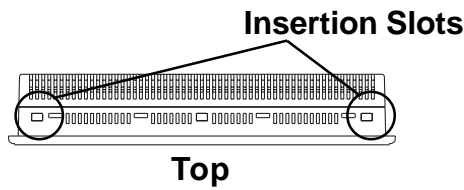

2) Insert the installation fasteners into the FP's insertion slots, at the top and bottom of the unit. (total: 4 slots)

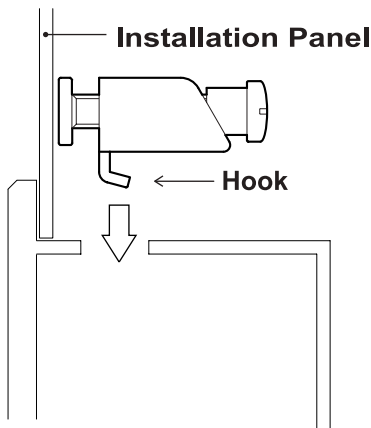

3) Insert each of the fasteners shown below. Be sure to pull the fastener back until it is flush with the rear of the attachment hole.

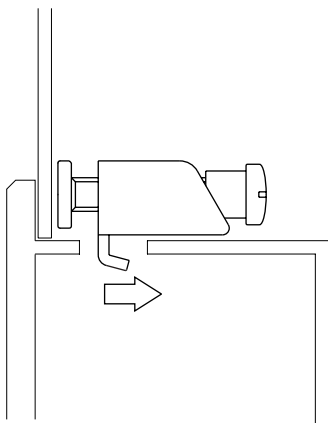

## Installation and Wiring

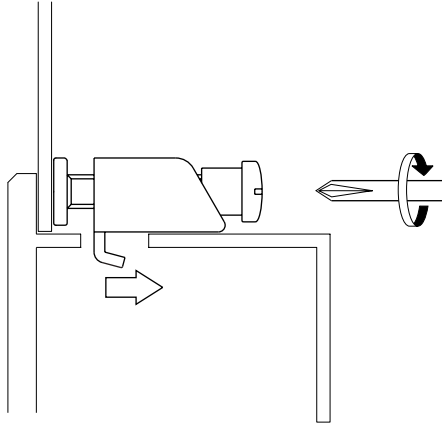

- 4) Use a Phillips screw driver to tighten each fastener screw and secure the FP in place.



Do not use too much force, since it may damage the FP unit. A torque of only 0.5 N•m is sufficient to tighten these screws.

# Installation and Wiring

## 3-2 Wiring

### 3-2-1 Power Cable Connection

# Warning

- To prevent electrical shocks, be sure the Power Cable is plugged first into the FP unit, then into the wall (main supply).
- Your FP2500-T41-24V uses input voltage of only DC24V. If your power supply is greater than that required by your unit, it may damage both the power source and the FP unit.
- In lieu of the power switch on the FP unit, please connect a breaker unit.



- When connecting the FG terminal, be sure to connect the ground wire. Not grounding the FP unit will create excessive noise and vibration.
- Wherever possible, use thick wires (max. 2mm<sup>2</sup>) for power terminals, and provide an extra twist to the wire before connecting it.



- The ring terminal size should be as follows.

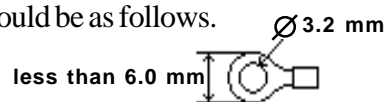

- To avoid a power short when loosening power terminal screws, use a power terminal with plastic sleeves.

FP2500-T41 (Rear)

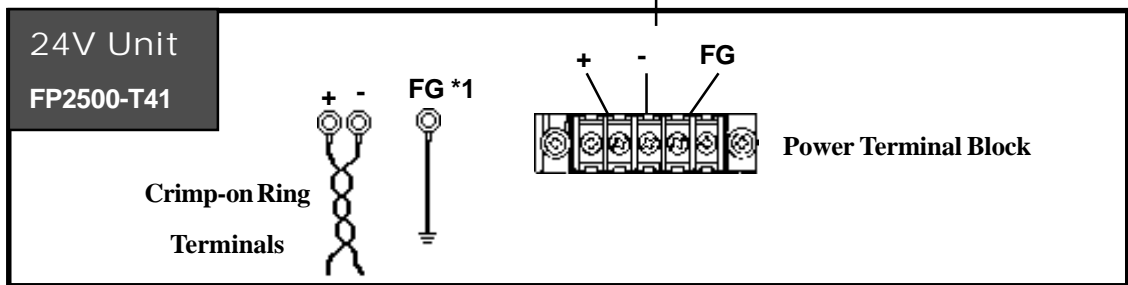
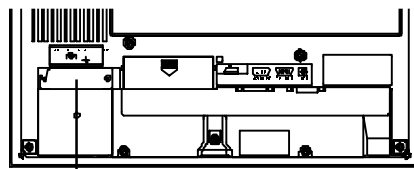

- \*1 The three power terminals are:
- DC24V + = Positive electrode
  - DC24V - = Negative electrode
  - FG = Grounding Terminal connected to the FP chassis

## Installation and Wiring

Connect the FP power cable as follows:

- 1) Check to make sure the FP's power cord is disconnected.
- 2) Remove the plastic terminal cover.
- 3) Remove the screws from the 3 middle terminals, align the power wire connectors and re-insert the screws. (Check each wire to make sure it is securely connected)



Use no more than 0.5 to 0.6N•m of torque to tighten the screws.

- 4) Replace the plastic terminal cover.

### 3-2-2 Connecting the Power Supply

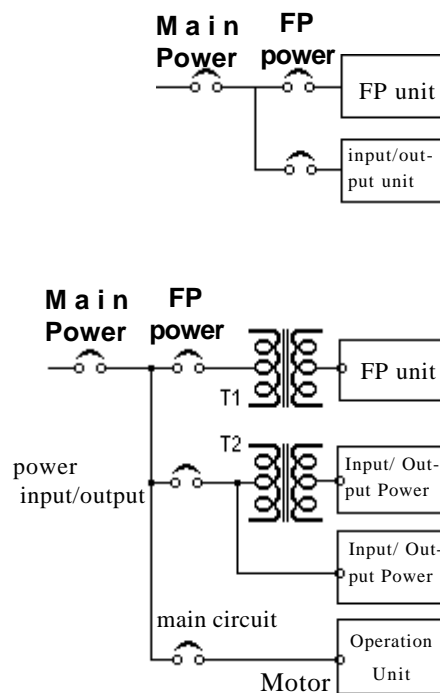

- When supplying power to the FP unit, please separate the input/output and operation unit lines, as shown.
- To increase the noise resistance quality of the power cable, simply twist each power wire before attaching the Ring Terminal.
- The power supply cable must not be bundled or positioned close to main circuit lines (high voltage, high current), or input/output signal lines.
- Connect a lightning surge absorber, as shown in the diagram, to deal with power surges.
- To avoid excess noise, make the power cable as short as possible.

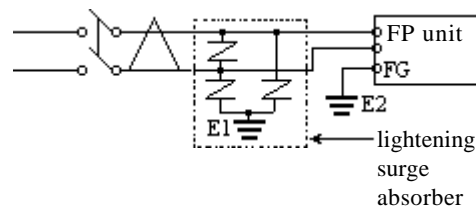

- **Be sure to ground the surge absorber (E1) separately from the GP unit (E2).**
- **Select a surge absorber that has a maximum circuit voltage greater than that of the peak voltage of the power supply.**

# Installation and Wiring

## 3-2-3 Precautions: Grounding

---

### (a) Exclusive grounding (BEST)

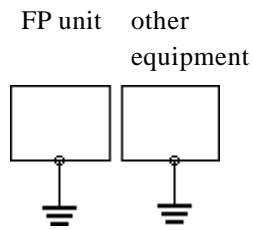

### (b) Common grounding (OK)

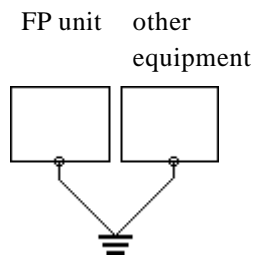

### (c) Common grounding (BAD)

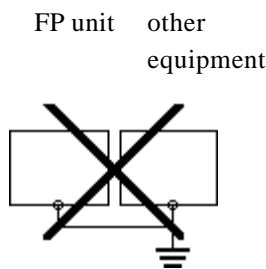

- Connect the FP's FG terminal to an exclusive ground. [diagram(a)- Grounding resistance of under 100Ω.]
- If exclusive grounding is not possible, use a common connection point. [diagram (b)]
- The grounding wire should have a cross sectional area greater than 2mm<sup>2</sup>. Make the connection point as close to the FP unit as possible, and make the wire as short as possible. When using a long grounding wire, replace the thin wire with a thicker wire placed in a duct.
- If this equipment does not function properly when grounded, disconnect the ground wire from the FG terminal.

## 3-2-4 Precautions: Input/Output Signal Lines

---

- Input and output signal lines must be separated from operating circuit power cables.
- If this is not possible, use a shielded cable and connect the shield to the FP chassis.



**3-3 Operation Mode Setup and Display Positioning**

**3-3-1 Operation Mode Setup and Adjustment**

The setup switches (dip-switches) are located in the rear of the unit.

FP2500-T41 (rear view)

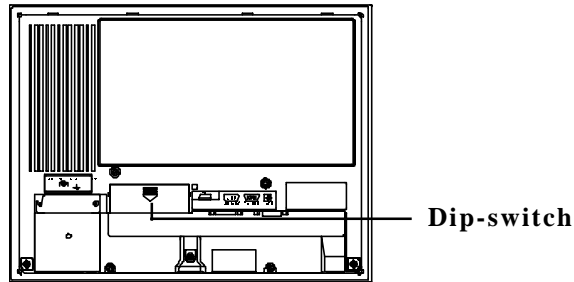

The default settings for the FP were created based on the standard connection method used with IBM-PCs.

Use these dip switches to control the FP unit's display features. If it does not display images properly with the standard settings shown below, please adjust the switches.

**SW1**

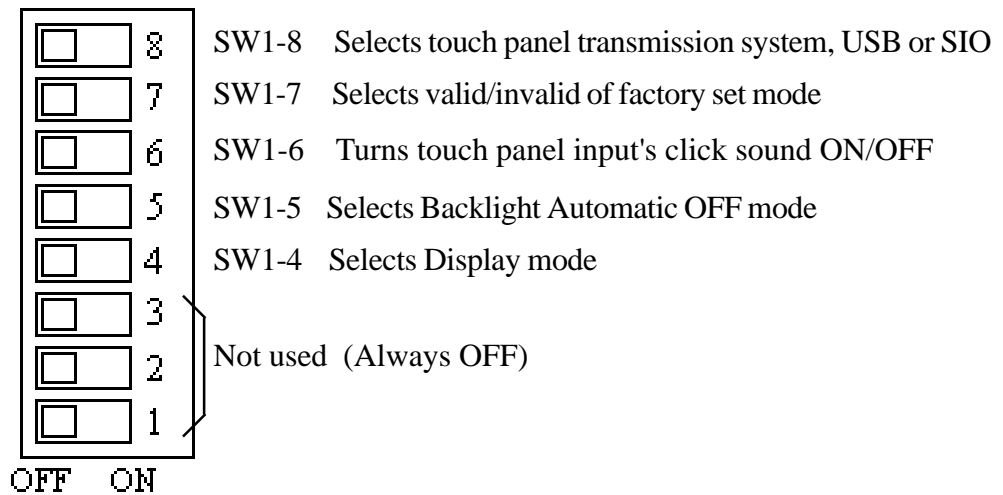

## Installation and Wiring

### • SW1-4

This switch is used to designate the FP's display mode.

SW1-4	Display Mode
OFF	VGA Graphics & text mode
ON	VGA Graphics mode

For more details, refer to 2-3-1 'Analog RGB Interface'.

### • SW1-5

This switch controls the Automatic Backlight OFF mode.

When this switch is ON, and if there is no SIO transmission or touch operation performed for 5 minutes, the backlight turns off automatically. It will remain OFF until another SIO transmission or touch operation takes place, at which time the backlight automatically turns back on.

If the FP unit is frequently not used, please set this switch ON to extend the life of the backlight. Also, if a display related command is transmitted by the SIO, this Automatic Backlight OFF mode will be automatically disabled.

FP does not have Power Save Mode.

### • SW1-6

This controls is used as the touch screen Click sound's ON/OFF switch.

When this is set to ON, a click will sound every time the touch panel is touched.

### • SW1-7

This is a switch to shift as adjustment mode at factory.

Please set this switch OFF when the FP unit is used.

### • SW1-8

This is a switch to change the data input (command control) of the touch panel.

Data output and command input/output will be performed from the USB connector when this is ON and from the RS232C connector when it is OFF.

### 3-3-2 Front LED Operation Mode Display

	LED Condition	Light OFF	Green	Orange lighting	Green/Red blinking	Orange blinking
Panel		Power OFF	Power ON	Power ON	Power ON	Power ON
Backlight		—	Normal	Normal	Bulb burned out	Bulb burned out
Image input		—	Yes	No	Yes	No

## 3-3-3 Display Position Compensation by OSD

---

The OSD (On Screen Display) is the screen menu displayed on the central part of the screen when the following FP startup is performed.

### 1) OSD Startup Method

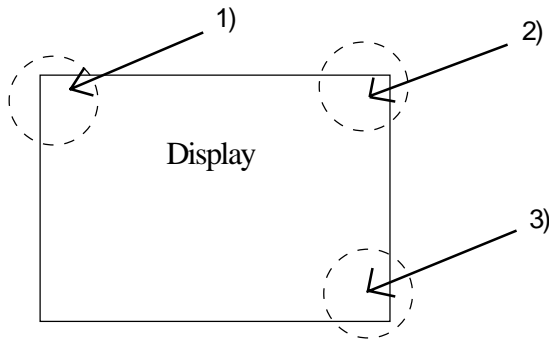

Touch the screen within 5 seconds in order of 1) , 2) and 3).

### 2) Main Menu

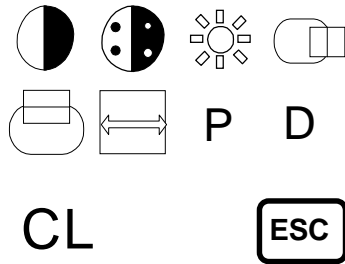

The left illustrations are the main menu of OSD.

By touching the characters on the display screen, you can switch to that screen adjustment mode.

Touching the ESC key will exit OSD mode.

## Installation and Wiring

### 3) Characters and their functions



**Contrast adjustment :**  
The function to adjust Contrast



**Sub-contrast adjustment :**  
The function to adjust contrast of each RGB color.



**Brightness adjustment :**  
The function to adjust brightness of colors.



**Horizontal display position adjustment :**  
The function to adjust horizontal position of the display screen.



**Vertical display position adjustment :**  
The function to adjust the vertical position of the display screen.



**Horizontal size adjustment :**  
The function to adjust the horizontal size of the screen.

**P**

**Phase adjustment :**  
The function to compensate the flicker.

**D**

**Dimmer function :**  
The function to compensate the flicker of backlight.

**CL**

**Setup value clear :**  
Returns all setup values shall be returned to default values.



**Closes the OSD.**



**Saves the setup values.**

## 4) Menu Settings

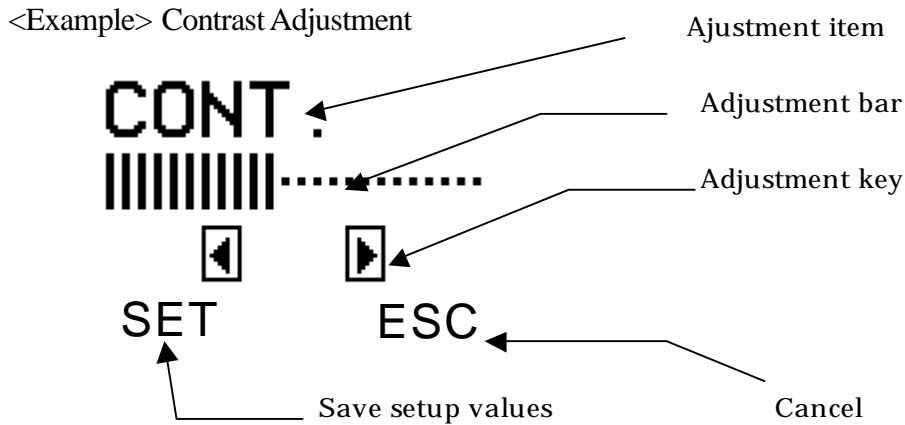

The value for each setting item can be increased or decreased by pushing the adjustment key.

- Contrast, Sub Contrast :  
Higher contrast can be obtained by the value +.
- Brightness :  
A hue can be brightened by the value +.
- Horizontal Display Position Adjustment :  
Display moves right by pressing the value +.
- Vertical Display Position Adjustment :  
Display moves up by pressing the value +.
- Horizontal Size Adjustment :  
Screen size can be enlarged horizontally by the value +.
- Phase Adjustment :  
CLK phase can be slowed by the value +.
- Dimmer Adjustment :  
Backlight can be brightened by the value +.

Push the SET key to save the setup value. Pushing the ESC key will return you to the main menu.

### Clearing the Setup Value

**ALLCLEAR**  
**START**  
**ESC**

Push the character CL and it will shift to this screen. When you push START, all setup data of the adjustment items will be returned to default value (factory set up value). By pushing the ESC key, you will return to the main menu.

## Chapter 4

# Touch Panel Commands

1. Command List
2. Boot-up Initialization
3. Touch Interface Data
4. Touch Panel Commands

### 4-1 Command List

Here, the touch panel commands ( host -> touch panel ) supported by the FP2500-T41 are described. The comma (,) used between the transferred format sent by the touch panel to the host computer is only for separating commands, and has nothing to do with the actual touch panel commands.

Command codes and data are all expressed in hexadecimal format.

(Example: 65h = 65 HEX)

#### <Touch Panel Commands>

Regardless of the dip-switch settings, the FP's display, click sound and buzzer can all be controlled from the host computer by sending one-character touch panel commands to the FP unit. The dip-switch settings are only enabled when the FP is turned ON.

Code	Function
65h / 67h	Display ON
66h / 68h	Display OFF
69h	Click sound (high) ON
6Ah	Click sound (high) OFF
6Bh	Click sound (low) ON
6Ch	Click sound (low) OFF
71h	Buzzer (high) ON
72h	Buzzer (high) OFF
73h	Buzzer (low) ON
74h	Buzzer (low) OFF

### 4-2 Boot-up Initialization

When the power is turned ON, the touch panel is initialized as follows.

- Clears its internal buffer.
- Initializes the serial communication mode.

Baud rate	9600bps
Data length	8 bits
Parity	none
Stop bit	1 bit

- Initializes the system default values.

Function	Default Setting
Display output	ON
Backlight	ON
Click sound	ON or OFF selected with Dip SW1-6 (high)
Buzzer	OFF
Automatic OFF mode	ON or OFF selected with Dip SW1-5

## Touch Panel Commands

### 4-3 Touch Interface Data

Since the FP uses an analog type touch panel, all 640 x 480 coordinates can be detected. Resolution of the analog touch panel is 1024 x 1024, so a conversion program to convert the coordinates to 640 x 480 becomes necessary.

Also, a calibration program to adjust the actual touch position is needed.

As a result, the following software is included with the FP2500-T41 unit.

FPATPH.EXE ...Passes 640 x 480 touch coordinate data to user program.

(This is not a mouse simulation program)

FPCALIB.EXE .Calibrates the touch coordinate data to the actual touch position. This program is to be used with FPATPH as a set.

#### OS and Touch Panel Driver Combinations

OS	Touch I/F Program	Calibration
Windows <sup>(R)</sup> NT	PL-TD000	Feature included in the touch I/F program
Windows <sup>(R)</sup> 95	PL-TD000	Feature included in the touch I/F program
Windows <sup>(R)</sup> 98	PL-TD000	Feature included in the touch I/F program
Windows <sup>(R)</sup> 2000	PL-TD000	Feature included in the touch I/F program
DOS	FPATPH	FPCALIB.EXE
Others	user programmed	user programme

#### ■ Touch Panel Coordinate Data

##### (1) Resolution

Both the X and Y coordinates have a resolution of 1024.

The origin point (0,0) is located in the upper left corner of the screen.

(0,0)

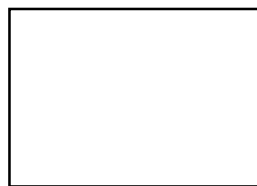

(1023,1023)

Screen display origin, with resolution of 640 x 480, is normally at the upper left corner of the screen. Therefore, a software to convert the touch coordinates to display coordinates is needed.



# Touch Panel Commands

## (2) Data Format

All data is in binary format.

Header: 1 byte (11h= touched; 10h = released)  
 X coordinate: 2 bytes (0 to 3FFh)  
 Y coordinate: 2 bytes (0 to 3FFh)

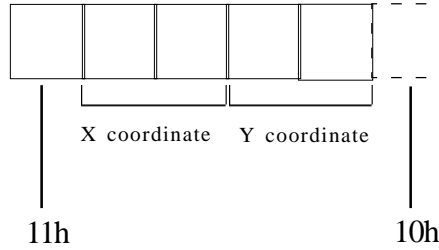

added when touch is released.

<Example> If the coordinate (X=23(11h), Y=500(1F4h)) is touched.

11h 0h 17h 1h F4h	—	touched
11h 0h 17h 1h F4h	—	continuous output with the same location
11h 0h 17h 1h F4h	—	moving the location without releasing touch
11h 0h 17h 1h F4h	}	continuous data output unless finger is released
•		
•		
•		
11h 0h 17h 1h F4h	}	when released, only 1 unit of data is sent
11h 0h 17h 1h F4h 10h		

## (3) Sampling Rate

A maximum of 87 points per second.

## Touch Panel Commands

### 4-4 Touch Panel Commands

The following are touch panel commands sent from the host computer to the FP unit.



The letter inside the bracket next to the command code shows the actual character used for that code.

<b>Display ON</b>	<b>65h ( e ) / 67h ( g )</b>	<b>RS232C</b>
	<b>65h ( e ) / 67h ( g )</b>	<b>USB</b>

Turns on FP2500-T41's display. Backlight is also turned on simultaneously.

<b>Display OFF</b>	<b>66h ( f ) / 68h ( h )</b>	<b>RS232C</b>
	<b>66h ( f ) / 68h ( h )</b>	<b>USB</b>

Turns off FP2500-T41's display. Backlight is also turned off simultaneously.



- When the display is turned off by using this command, it is necessary to write the Display ON command to turn it on again.
- Unlike when making the display turn off by automatic backlight OFF mode, the display will not reappear by touching the panel. Further, the Automatic Backlight OFF mode is set up by the Dip Switch 1-5 and the mode will be decided by the Dip Switch setup condition when the power source of the FP unit is turned on.

<b>Click sound (high) ON</b>	<b>69h ( i )</b>	<b>RS232C</b>
	<b>69h ( i )</b>	<b>USB</b>

Makes a high click sound when the touch panel is touched.

<b>Click sound (high) OFF</b>	<b>6Ah ( j )</b>	<b>RS232C</b>
	<b>6Ah ( j )</b>	<b>USB</b>

The high click sound is disabled.

<b>Click sound (low) ON</b>	<b>6Bh ( k )</b>	<b>RS232C</b>
	<b>6Bh ( k )</b>	<b>USB</b>

Makes a low click sound when the touch panel is touched.

<b>Click sound (low) OFF</b>	<b>6Ch ( l )</b>	<b>RS232C</b>
	<b>6Ch ( l )</b>	<b>USB</b>

The low click sound is disabled.

## Touch Panel Commands

**Buzzer (high) ON**    **71h (q)    RS232C**  
    **71h (q)    USB**

Turns on the buzzer output (high).

**Buzzer (high) OFF**    **72h (r)    RS232C**  
    **72h (r)    USB**

Turns off the buzzer output (high).

**Buzzer (low) ON**    **73h (s)    RS232C**  
    **73h (s)    USB**

Turns on the buzzer output (low).

**Buzzer (low) OFF**    **74h (t)    RS232C**  
    **74h (t)    USB**

Turns off the buzzer output (low).

The order of priority for the buzzer and click sounds is as follows. They are not processed simultaneously.

Sound	Command Code	Priority Order
Buzzer (high) ON	71h	high
Buzzer (low) ON	73h	↑
Click sound (high) ON	69h	↓
Click sound (low) ON	6Bh	low

Also, if the OFF command for each buzzer item is sent, regardless of the priority order, only that buzzer item is turned off.

<Example>

If the following three commands are sent at the same time...

Buzzer (high) ON

Buzzer (low) ON

... the Buzzer (high) activates. However, when the Buzzer (high) OFF command is sent afterwards, the Buzzer (low) will activate.

## Touch Panel Commands

### Reserved

The following commands are reserved. If these commands are used, they are sometimes treated as errors.

00h	Reserved
01h	
02h	
05h	
0Ah	
0Bh	
0Dh	
0Eh	
0Fh	
14h	
15h	
16h	
17h	
18h	
19h	
1Bh	
1Dh	
20h	
21h	
22h	
23h	
25h	
26h	
27h	
28h	
29h	
2Ah	
2Bh	
31h	
33h	
3Ah	
3Ch	
41h	
42h	
43h	
44h	
45h	
46h	
47h	
55h	



## Chapter 5

# Touch Panel

# Communication Programs

1. **Bundled Software**
2. **Operation Environment**
3. **Touch Panel Input Drivers**

### 5-1 Bundled Software

The 3.5 inch floppy disk pictured below, included with the FP unit, contains the following utilities:

- A touch panel handler -- for easy detection of touch panel data
- A FPcalibration program -- for making touch coordinate adjustments.

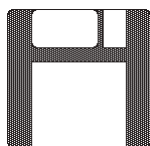

Touch panel handler : FPATPH. EXE

Touch panel data FPcalibration program : FPCALIB. EXE



These programs only run on PC/AT compatible machines under the MS-DOS environment.

Do not use a USB cable.

# Touch Panel Communication Program

## 5-2 Operation Environment

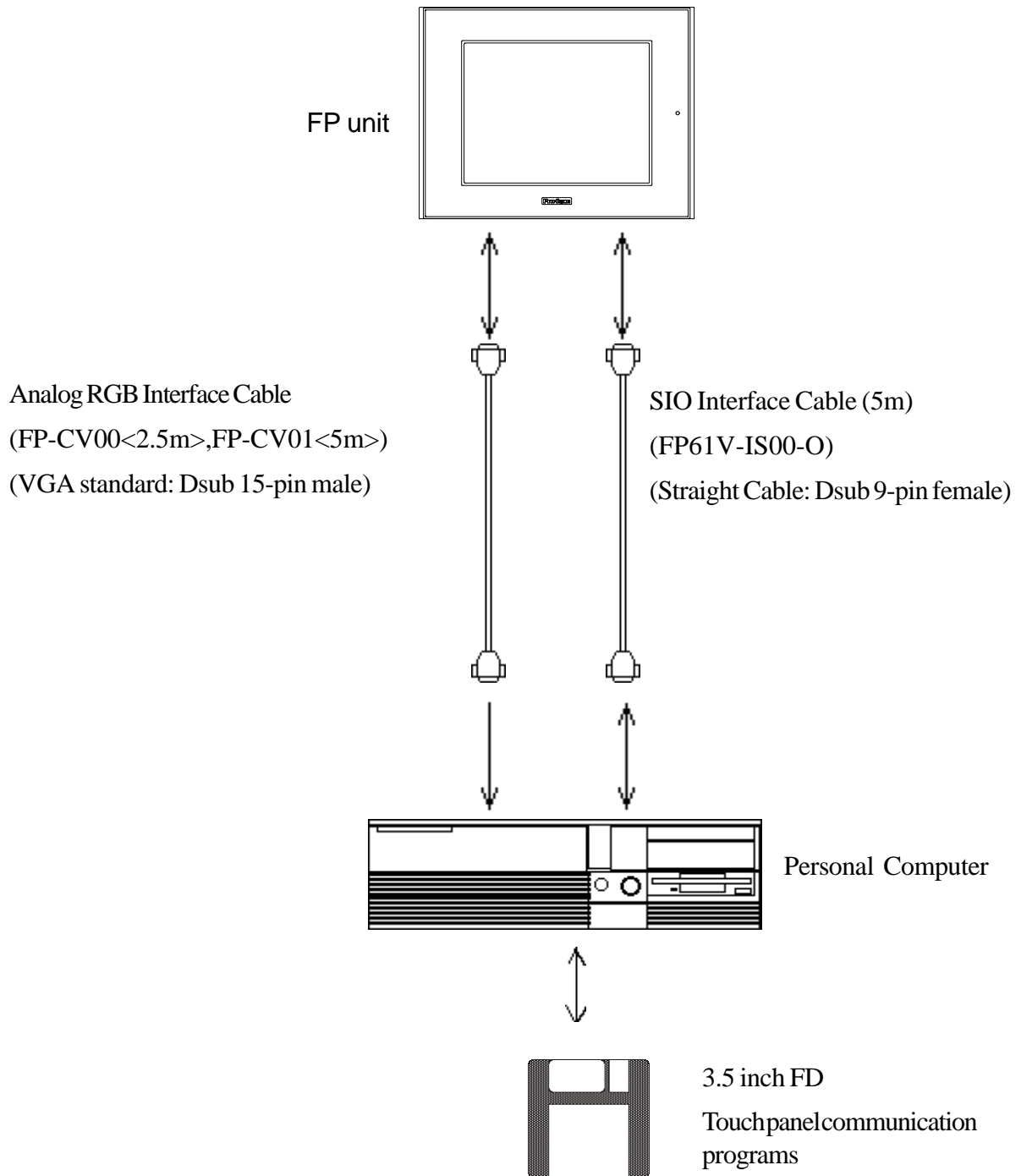

# Touch Panel Communication Program

## 5-3 Touch Panel Input Drivers

### 5-3-1 FPATPH.EXE (Touch Panel Handler)

Input for the analog touch panel is carried out at a resolution of 1024 x 1024 dots, with the origin point located in the upper right corner of the panel. The origin point of the display panel, however, is located in the upper left corner, and its resolution is 640 x 480 dots.

Since the coordinates of the touch panel and the display panel do not match, the FPATPH.EXE (Touch panel handler) is used to convert touch panel input data to match the both resolution and the origin point of the display panel, so that it can pass the absolute input coordinates to the application software.

The following picture shows the relation between the touch panel and the display panel coordinates.

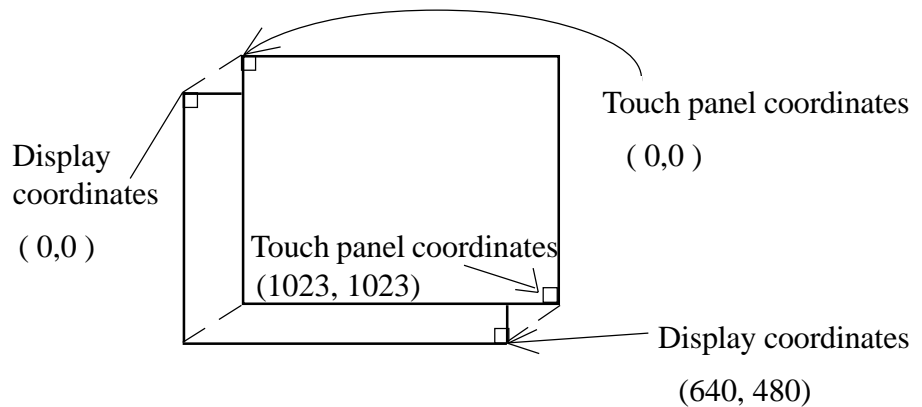

\* The touch panel coordinates are converted to the display coordinates when "FPATPH.EXE" is activated.



# Touch Panel Communication Program

## ■ How to Operate the Software

FPATPH [parameter] or FPATPH -r 

### \* Explanation of parameters

-a <n>Selects the I/O base address of the SIO port where the touch panel is connected.

(hexadecimal, default = 2f8)

n = 3f8 (COM1)

2f8 (COM2)

-q <n>Selects the interrupt level (IRQ) for the SIO port where the touch panel is connected. (default = 3)

n = 4 (COM1)

3 (COM2)

-i<n> Sets the vector number for the function call's software interrupt. (hexadecimal, default = 59)

-r Removes the current (resident) memory command.

-c <path> Specifies the data file made by FPCALIB.EXE (touch panel data FPCalibration) that contains the correction value. ("FPATPH. CAL" in the current directory is selected for default.)

When this program runs, the following message will display on the screen.

Analog Touch Panel Handler FPATPH. EXE Version 1.00  
Copyright (c) 1993 Digital Electronics Corporation

Stay resident.

After execution, the command stays in memory.



When the data file made by FPCALIB. EXE is not found or cannot be opened, the following message appears. In such a case, the program will run without data correction.

WARNING !! Can't open CAL file.  
Stay resident.

If data correction is not carried out successfully, the display position may not match with the touch panel input position.

# Touch Panel Communication Program

## ■ Function

FPATPH.EXE has the following functions, which are activated by software interrupt (Default = INT59H) function calls.

< INT 59H Function List >

Function Code	Contents
8100h	Touch panel input (infinite wait)
8101h	Touch panel input (instant return)
8102h	Non-destructive input
0200h	Input buffer clear
8500h	Detection of touch panel's condition
FE00h	Resident Confirmation

## ■ Function Explanation

Function 8100h	Touch panel input ( infinite wait)
----------------	------------------------------------

Returns touch coordinates. Waits infinitely for input.

< input > AX = 8100h

< output > AH = 0 : normal termination

BX = Y : coordinate ( 0 - 479 )

DX = X : coordinate ( 0 - 639)

CX = Number of effective input buffer for the analog touch panel.

Function 8101h	Touch panel input ( instant return )
----------------	--------------------------------------

Returns touch coordinates. It will quit the function if there is no input.

< input > AX = 8101h

< output > AH = 0 : input

1 : no-input

BX = Y : coordinate ( 0 - 479 )

DX = X : coordinate ( 0 - 639)

CX = Number of effective input buffer for the analog touch panel.

Function 8102h	Non-renewing touch panel input
----------------	--------------------------------

Sends the position coordinates, and does not renew the panel's input buffer.

< input > AX = 8102h

< output > AH = 0 : input

1 : no-input

BX = Y : coordinate ( 0 - 479 )

DX = X : coordinate ( 0 - 639)

CX = Number of effective touch panel input buffers.

## Touch Panel Communication Program

Function 0200h	Input buffer clear
----------------	--------------------

Clears the touch panel's input buffer.

< input > AX = 0200h

< output > AH = 0 : normal end

Function 8500h	Detection of touch panel's conditions
----------------	---------------------------------------

Returns the touch panel condition.

< input > AX = 8500h

< output > AH = status at 640 x 480 mode

Bit 1	Bit 0	Contents
0	0	touched
0	1	no-change
1	0	(not used)
1	1	released

Function FE00h	Confirmation of resident memory
----------------	---------------------------------

If FPATPH.EXE is resident in memory, a fixed message and its version number are returned.

< input > AX = FE00h

< output > AH = 0 : normal termination

BL = 'Y'

BH = 'B'

CX = version number

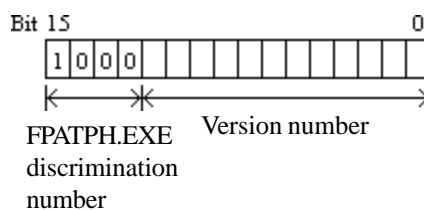

Carry = clear

# Touch Panel Communication Program

## 5-3-2 FPCALIB.EXE (Touch Panel Data FPCalibration)

Because of changes in operational environment and the unit's deterioration, differences in theoretical and actual touch coordinates arise; and therefore these differences must be corrected periodically, via a utility software called FPCALIB.EXE (touch panel data FPCalibration).

By touching the designated position on the display (upper left and lower right), FPCALIB.EXE calculates the difference between the theoretical and actual coordinates. Then, from the result, a correction data file to be used by FPATPH (touch panel handler) is made.

### ■ How to Operate

FPCALIB -d [ parameter ]

\* Explanation of parameters

- a <n> Selects the I/O base address of the SIO port where the touch panel is connected. (hexadecimal, default = 2f8)  
n = 3f8 (COM1)  
2f8 (COM2)
- q <n> Selects the interrupt level (IRQ) for the SIO port where the touch panel is connected. (default = 3)  
n = 4 (COM1)  
3 (COM2)
- c <path> Specifies the data file made by FPCALIB.EXE (touch panel data FPCalibration) that contains the correction value.



When the touch panel is connected to COM2, the default value can be used.

### ■ Operation Procedure

```
■ Analog Touch Panel Calibration FPCALIB.EXE
  Version 1.00
  Copyright(c)2000 Digital Electronics
  Corporation

  Calibration Mode

  Touch upper left and lower right corner of the
  screen.
  [Enter] : Go to test mode.
  [Esc]  : Terminate program.
  Upper left  Lower right
  (0000,0000) (0000,0000) ■
```

- 1) When FPCALIB. EXE is executed, the message on the left displays on the screen. Then the two designated position, upper left and lower right corners, starts to blink.

## Touch Panel Communication Program

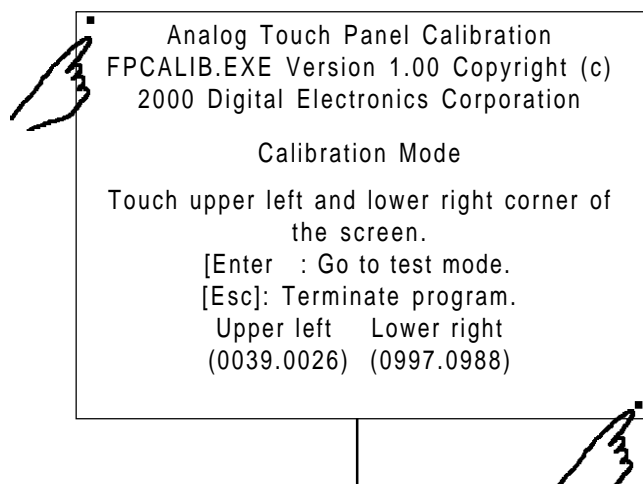

The actual value is shown on the display.

Terminate program without saving calibration data?(Y/N)

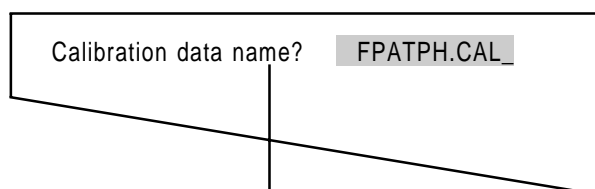
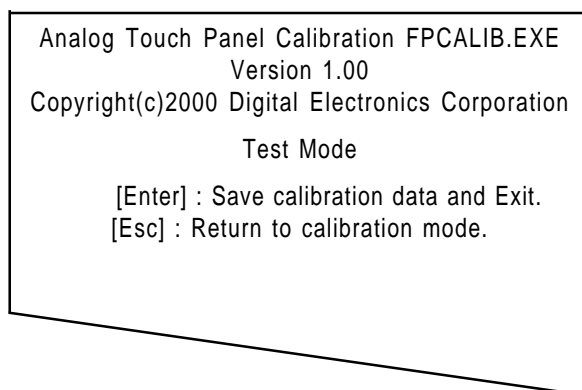

Enter the file name

2) Touch the designated positions, one after the other.



- Do not touch two points at the same time.
- Touch right above the designated position.
- By re-touching the points, the actual coordinates will redisplay.

Correction data will be calculated from the difference between the actual and the theoretical values.



Press the [Esc] key to terminate the program. Press the [Y] key after the message on the left is shown, and the program will terminate without saving any FPcalibration data. If the [N] key is pressed, the system will return to "FPcalibration mode".

3) To enter "test mode", press the [Enter] key.

This mode tests whether the FPcalibration has been processed correctly or not. The FPcalibration is confirmed as successful if the locus shown on the display matches as touched. Otherwise, return to the "FPcalibration mode" and redo the FPcalibration by touching the right blinking position.



Press the [Esc] key to return to "FPcalibration mode".

4) If the test result is OK, press the [Enter] key. After the following message appears, enter the name of the data file and press the [Enter] key.



When the data filename is specified from the parameter (-C=[path]) during the execution of FPCALIB.EXE, the program will terminate without showing the message on the left.

# Chapter 6

# Troubleshooting

## 1. Troubleshooting

### 6-1 Troubleshooting

#### 6-1-1 Possible Device Problems

Possible types of trouble while using this unit are as follows.

##### No display

- No display appears after the unit is switched on.
- The screen disappears during running mode.
- The screen does not display normally.

##### Touch panel doesn't function

The touch panel does not react when pressed, or its reaction time is abnormally long.



### Warning

- Because of the danger of electric shocks, be sure the power cable is not connected when wiring the unit.
- When changing the backlight, there is a danger of electric shocks or burns, so be sure to turn the unit OFF and wear gloves.



This section assumes that the FP is the cause of a problem, not the host.  
When the host is the problem, please refer to its corresponding manual.

6-1-2 No Display

When the screen does not display when powering up, or if the screen turns OFF by itself, use the flowchart below to find an appropriate solution.

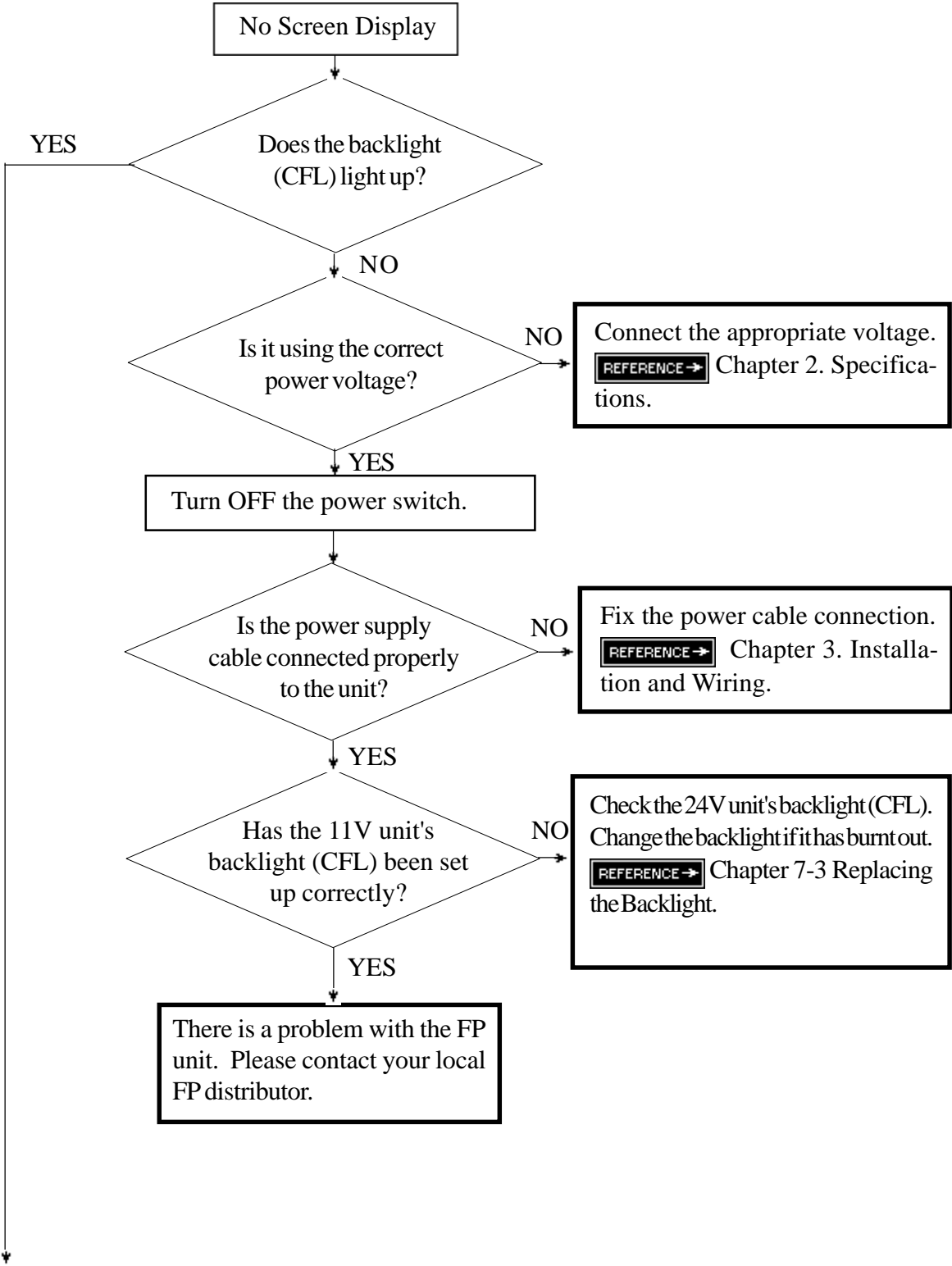

# Troubleshooting

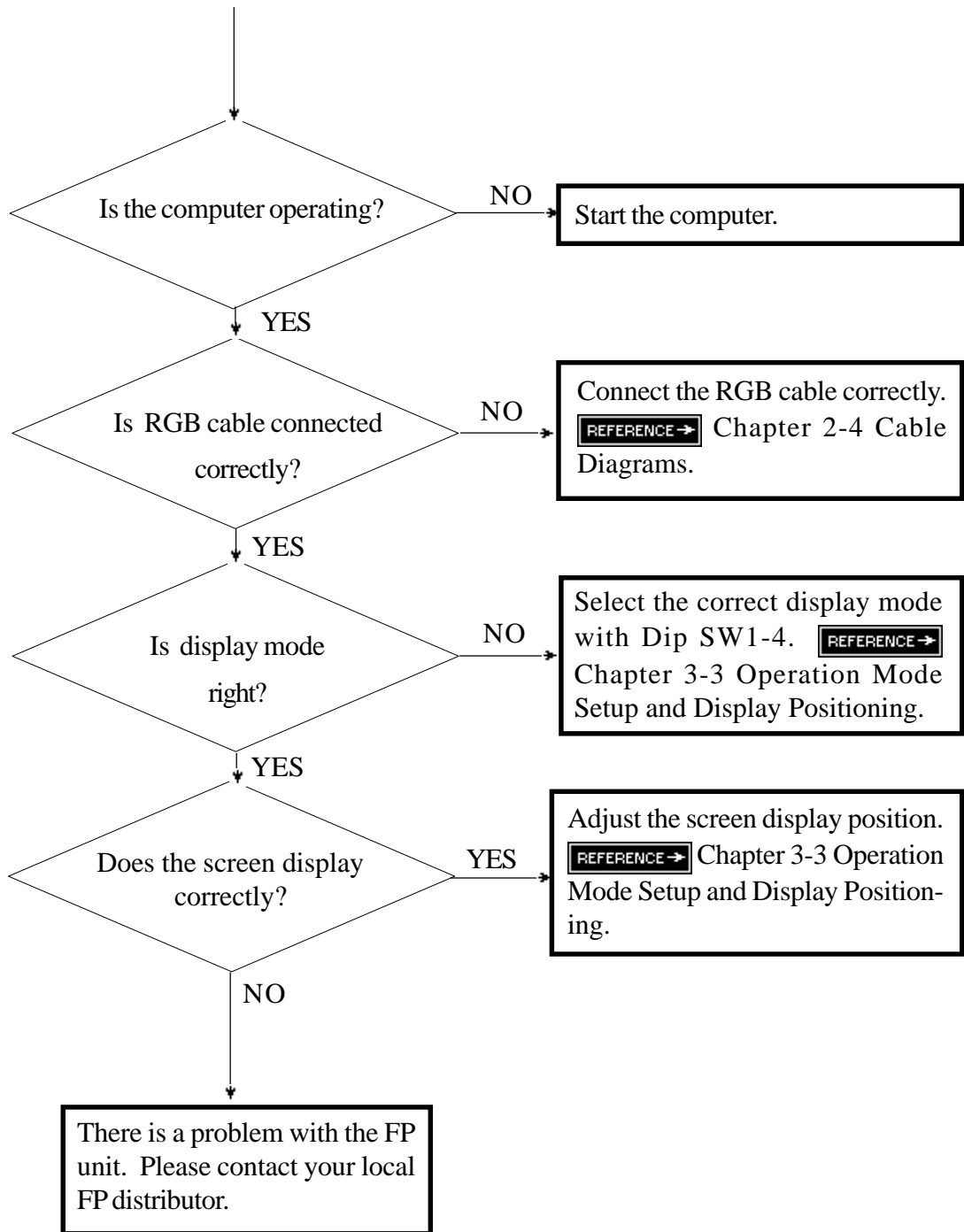



## 6-1-3 The Touch Panel Does Not Work

When the touch panel does not react, or its reaction is very slow after it is pressed, follow the flowchart below to find the origin of the problem and the appropriate solution.



From a personal computer, touch panel data communication can be performed by the CALIB.EXE program. Please execute CALIB.EXE to check touch panel's operations.

**REFERENCE →** 5-3-2 CALIB.EXE (Touch Panel Data Calibration)

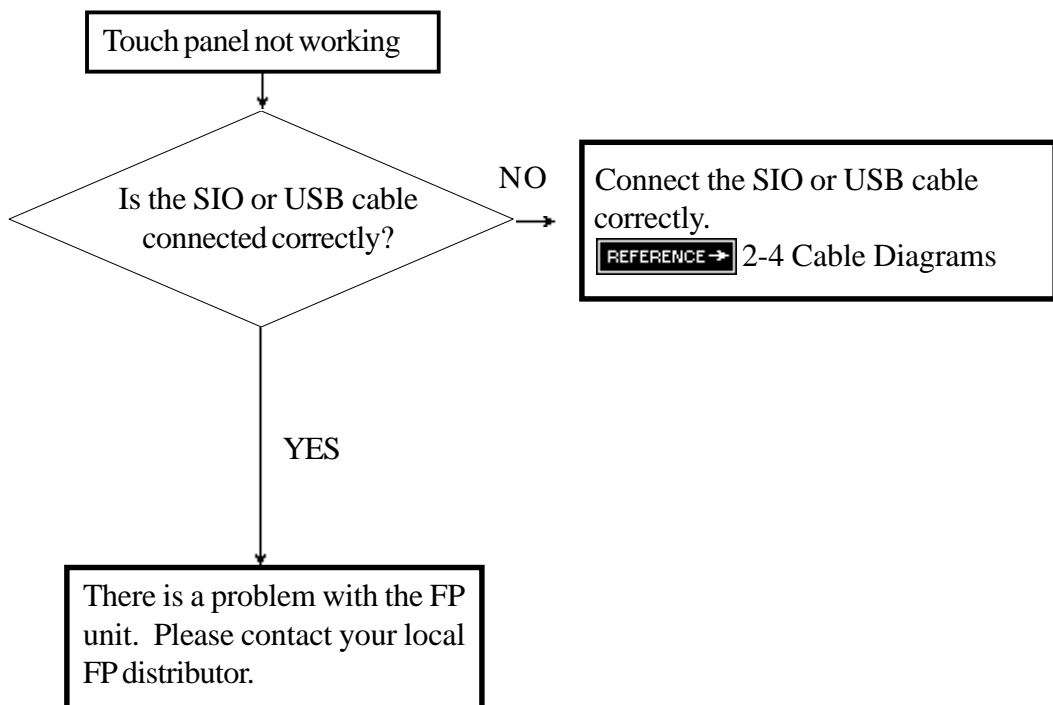

# Chapter 7

## Maintenance

1. Regular Cleaning
2. Periodic Check Points
3. Changing the Backlight

### 7-1 Regular Cleaning

#### 7-1-1 Cleaning the Display

When the surface or the frame of the display gets dirty, soak a soft cloth in water with a neutral detergent, wring the cloth tightly, and wipe the display.



- Do not use paint thinner, organic solvents, or a strong acid compound to clean the unit.
- Do not use hard or pointed objects to operate the touch-screen panel, since it can damage the panel surface.

#### 7-1-2 Installation Gasket Check/Replacement

The installation gasket protects the FP and improves its water resistance. For instructions on installing the FP's gasket, refer to

**REFERENCE** → *Chapter 3 "Installation and wiring"*



**A gasket which has been used for a long period of time may have scratches or dirt on it, and could have lost much of its water resistance. Be sure to change the gasket at least once a year, or when scratches or dirt become visible.**

#### ■ Installation Gasket Attachment Procedure (all units)

- 1) Place the FP on a flat, level surface facing the display face downwards.
- 2) Remove the gasket from the FP.

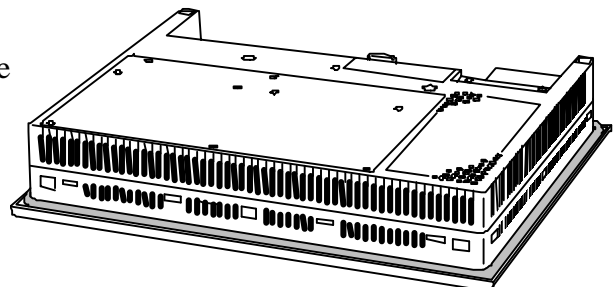

## Maintenance

- 3) Attach the new gasket to the FP. Be sure to insert the gasket into the GP's groove so that the gasket's groove sides are vertical.
- 4) Check if the gasket is attached to the FP correctly.

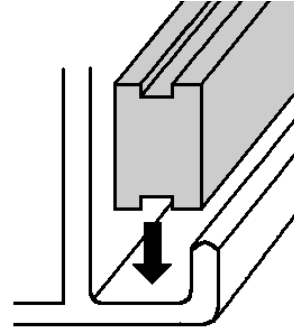

- **The gasket must be inserted correctly into the groove for the FP's moisture resistance to be equivalent to IP65f.**
- **The upper surface of the gasket should protrude approximately 2mm out from the groove. Be sure to check that the gasket is correctly inserted before installing the FP into a panel.**

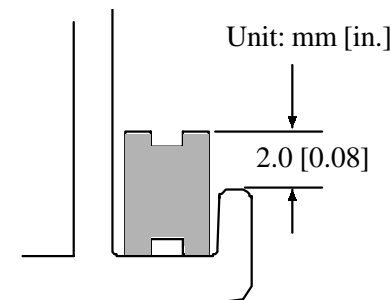

### 7-2 Periodic Check Points

To keep your FP unit in its best condition, please inspect the following points periodically.

#### FP Operation Environment

- Is the operating temperature within the allowable range (0°C to 50°C)?
- Is the operating humidity within the specified range (30% RH to 85% RH, dry bulb temperature of 39°C or less)?
- Is the operating atmosphere free of corrosive gasses?

#### Electrical Specifications

- Is the input voltage appropriate (DC19.2V to DC28.8V)?

#### Related Items

- Are all power cords and cables connected properly? Have any become loose?
- Are all mounting brackets holding the unit securely?
- Are there many scratches or traces of dirt on the installation gasket?

**7-3 Replacing the Backlight**

When the unit’s backlight burns out, the unit’s status LED will blink green/red or orange.

FP2500-T41 units use a CFL, long-life type backlight. The actual life of the backlight however, will vary depending on the FP’s operating conditions, and replacement may be required. A FP2500-T41 backlight has a life of 50,000 hours (approx. 5.7 years, at 25°C and 24 hour operation), when the backlight is lit continuously (time required for brightness to fall to half its normal level.)

 **Warning**

- To prevent an electric shock, be sure the FP’s power cord is unplugged from the power outlet prior to replacing the backlight.
- When the power has just been turned OFF, the unit and backlight are still very hot. Be sure to use gloves to prevent burns.
- The backlight is very fragile. Do not touch the glass tube directly or try to remove its power cord. If the glass tube breaks you may be injured.



Use the following table to check that you have ordered the correct backlight.

FP Model	Backlight Model
FP2500-T41	GP577R-BL00-MS
FP2600-T41	PS600-BU00

For backlight replacement details, refer to the replacement backlight unit’s installation guide.



# Index

## Symbols

3.5 inch floppy disk ix, 5-1

## A

Afterimage iv  
Analog RGB  
    interface viii, 2-4, 2-8, 2-10  
Analog RGB Interface Cable 1-1, 1-2, 2-8  
Angled face 3-2  
Automatic OFF Mode 3-8, 3-9, 4-5

## B

Backlight 1-2, 2-3, 7-3  
Boot-up Initialization 4-2  
Brightness 2-3  
Brightness adjustment 3-11, 3-12  
Bundled Software 5-1  
Buzzer 4-1, 4-6

## C

Cable Diagrams 2-8  
CAN/CSA-C22.2, Nos 142, and 213-M1987 x  
CE Marking x  
Cleaning the Display 7-1  
Click sound 3-8, 3-9, 4-1, 4-6  
Command List 4-1  
Common grounding 3-7  
Connecting the FP to a PC 1-1  
Contrast adjustment 3-11, 3-12  
Cover sheet 1-2  
Clearing the Setup Value 3-12

## D

Data Format  
    binary format 4-4  
Dimmer function 3-11, 3-12  
Dip switch 2-10, 3-8  
Disassembling iii  
Display Area 2-3  
Display colors 2-3  
Display Media 2-3  
Display mode vii, 2-3  
Display Position Compensation by OSD 3-10  
Dot Pitch 2-3

## E

Electrical Specifications 2-1, 7-2  
Environmental Specifications 2-1  
Exclusive grounding 3-7  
External Dimensions 2-2, 2-11

## F

Factory Set Mode 3-8, 3-9  
FG terminal 3-5, 3-7  
Flammable gas (environment) iii  
Flat Panel (FP) Dimensions 2-11  
FPATPH.EXE 4-3, 5-7  
FPCALIB.EXE 4-3, 5-7  
FP calibration program 4-3, 5-1, 5-7  
FP Installation  
    Dimensions 2-12  
FP Operation Environment 7-2  
FP Parts  
    Names and functions 2-10  
Front LED 2-10, 3-9  
Function Explanation 5-5  
Functional Specifications 2-3

## G

General Specifications 2-1  
Grounding 3-7  
Ground Connection 2-1  
Guidelines iii

## H

Header  
    Data Format 4-4  
High voltage iii  
Horizontal Installation 3-2  
Horizontal size adjustment 3-11, 3-12  
Horizontal display position adjustment 3-11, 3-12

## I

IA (Industrial Automation) viii  
Input Voltage 2-1, 3-5  
Insertion Slot 3-3  
Installation 3-1  
Installation Gasket ix, 3-1, 7-1  
Installation Guide ix  
Installation brackets ix, 1-2, 2-12, 3-3  
Interface Specifications 2-4  
Internal buffer 4-2  
IP65F 2-1

## I

IA (Industrial Automation) viii  
Input Voltage 2-1, 3-5  
Insertion Slot 3-3  
Installation 3-1  
Installation Gasket ix, 3-1, 7-1  
Installation Guide ix  
Installation brackets ix, 1-2, 2-12, 3-3  
Interface Specifications 2-4  
Internal buffer 4-2  
IP65F 2-1

## L

Liquid Crystal Display (LCD) iv

## M

Maintenance 7-1  
Maintenance parts 1-2  
Metallic dust iii  
Mouse Emulator 1-2  
MS-DOS 5-1

## N

Natural ventilation iv, 3-2  
Noise Endurance 2-1  
No Screen Display  
    Troubleshooting 6-2

## O

OA (Office Automation) viii  
Operating Temperature 2-1  
Operation Mode Setup 3-8  
Optional Equipment 1-2  
Overheat 3-2  
OSD 2-4, 3-10

## P

Packaging  
    Contents ix  
Phase adjustment 3-11, 3-12  
Pin Assignments 2-5, 2-6, 2-7  
PL-TD000 1-2, 4-3  
Possible Device Problems 6-1  
Power Cable Connection 3-5  
Power Input Terminal Block 2-10, 3-5  
Power Terminals 3-5  
Precautions: Grounding 3-7  
Precautions: Input/Output Signal Lines 3-7  
Precautions: Power Supply 3-6  
Priority  
    Buzzer and Click sounds 4-6

## R

Rubber gasket 1-2, 3-1

## S

Safety Instructions iii, iv  
Sampling Rate 4-4  
Serial Interface 2-6, 2-10  
Setup value clear 3-11, 3-12  
Sideways Installation 3-2  
Signal Names 2-5, 2-6, 2-7  
SIO Interface Cable 1-1, 1-2, 2-9  
Specifications  
    Electrical 2-1  
    Environmental 2-1  
    Interface 2-4  
    Structural 2-2  
Storage Temperature 2-1  
Structural Specifications 2-2  
Sub-contrast adjustment 3-11, 3-12  
Surge absorber 3-7  
Symbols ii

## T

TFT Color LCD viii, 2-10  
Touch Interface Data 4-3  
Touch Panel 2-3, 2-10  
Touch Panel Command 4-1, 4-5  
Touch Panel Coordinate Data 4-3  
Touch Panel Does Not Work  
    Troubleshooting 6-4  
Touch Panel Driver 4-3  
Touch Panel Handler 5-1, 5-3  
Troubleshooting 6-1

## **U**

- UL/c-UL x
- UL1604 x
- UL508 x
- UL Registration Model x
- User Manual ix
- USB Interface 2-7, 2-10
- USB Interface Cable 1-1, 1-2, 2-9

## **V**

- Vertical Installation 3-2
- Vertical display adjustment 3-11, 3-12
- Vibration Endurance 2-1
- Voltage Transformer 3-6

## **W**

- Weight 2-2
- Wiring 3-5
  - Grounding 3-7
  - Input/Output Signal Lines 3-7
  - Power Cable 3-5
  - Power Supply 3-6
- When Connecting to a PC vii



# *MEMO*